

# COMBO

2014 Models Edition 1



Proud Sponsor of Home Nations Football



# The Wheels of Business. Helping you deliver.

Whatever your line of business, Vauxhall Commercial Vehicles can help you deliver. With four different models we offer a massive choice of almost 300 variants including panel vans, chassis cabs, crew cabs, platform cabs,

tippers, dropsides, box vans and passenger carriers. We're also committed to keeping your business moving. That means reliable, fuel-efficient vehicles – including our new ecoFLEX range – supported by a dedicated network of over 450 retailers offering



the expert support and back-up you need. We build more commercial vehicles at our British production facilities than any other UK manufacturer. We've also won over 20 industry awards since 2010 – major awards,

presented by some of the toughest judges in the business. Introduce the in-built reassurance of the Vauxhall brand and it's easy to see why Vauxhall Commercial Vehicles really are 'The Wheels of Business'.





VX\_N\_COM\_18110.tif



VX\_N\_COM\_18111.tif



VX\_N\_COM\_18112.tif



VX\_N\_COM\_18113.tif



VX\_N\_COM\_18114.tif



VX\_N\_COM\_18115.tif



VX\_N\_COM\_18116.tif



VX\_N\_COM\_18117.tif



VX\_N\_COM\_18118.tif



VX\_N\_COM\_18119.tif



VX\_N\_COM\_18120.tif



VX\_N\_COM\_18121.tif



VX\_N\_COM\_18133.tif



VX\_N\_COM\_18123.tif



VX\_N\_COM\_18124.tif



VX\_N\_COM\_18125.tif



VX\_N\_COM\_18126.tif



VX\_N\_COM\_18127.tif



VX\_N\_COM\_18128.tif



VX\_N\_COM\_18129.tif



VX\_N\_COM\_18130.tif



VX\_N\_COM\_18131.tif



VX\_N\_COM\_18132.tif



VX\_N\_COM\_18133.tif



VX\_N\_COM\_18134.tif



VX\_N\_COM\_18135.tif



VX\_N\_COM\_18136.tif



VX\_N\_COM\_18137.tif



VX\_N\_COM\_18115.tif



VX\_N\_COM\_18139.tif



VX\_N\_COM\_18140.tif



VX\_N\_COM\_18141.tif



VX\_N\_COM\_18142.tif



VX\_N\_COM\_18143.tif



VX\_N\_COM\_18144.tif



VX\_N\_COM\_18145.tif

# COMBO. COMPACT, CAPABLE

**Want to give your business a lift?** Then get yourself a vehicle that delivers a long list of commercial firsts. Roomy, accessible and more than capable in the cargo department. It's also dependable, versatile and efficient to run. And with long wheelbase, high roof and Crew van models now available, it's more practical than ever. With capabilities such as these, one thing is certain: Combo really can help your business deliver.



Some of the vehicles shown include options and accessories available at extra cost. And not all of the features described are available on every model. So please check the Equipment and Technical Data section for further details. From time to time we may also offer alternative models such as Special Editions which are featured in separate literature or can be found on the Vauxhall website: [www.vauxhall.co.uk/vans](http://www.vauxhall.co.uk/vans)

## CONTENTS

## COMBO

Introduction	6
Cabin	8
Versatility	10
Body styles	12
Load area	14
Practicality	16
Comfort	18
Safety and infotainment	20
Engines and drivetrain	22
Variants	24
Combo range	26
Options and accessories	32
Colours and trims	34
Customer testimonials	36
Equipment	38
Technical data	42





# A LOAD OFF YOUR MIND

**Combo is quite simply first class.** Not only does it have one of the longest and most spacious load areas in its class, but it also has the highest rear axle weight and the largest rear door opening; combined with a useful, low rear loading height. The Combo Crew van, including the new Sportive model adds a comfortable three passenger rear seat and convenient twin sliding side-access doors. When it comes to key business tools, you always invest in the best. In both the long and short term, that makes it a seriously good investment.

**A weighty proposition.** The benefits don't end there. Combo 2300 models can haul up to a tonne. Yet the Combo boasts ultra-low fuel consumption figures – most notably on the ecoFLEX 1.3 turbo diesel engine with Start/Stop technology. It also has the longest wheelbase in its class, promoting excellent driveability. That's quite a combination and one less thing for business operators to worry about.

# A COMFORTABLE WORKPLACE

**Combo has all the creature comforts needed to create the ideal working environment.** The fascia is clearly laid out, switches easy to reach and controls easy to operate. And with reach- and rake-adjustable steering and a four-way adjustable driver's seat, you can quickly achieve the most comfortable driving position. Better still, the high-set seating provides an excellent view of the road. Other standard features include a fully-featured CD player/radio, while a broad choice of options – including sat nav and Bluetooth® – let you fine-tune your working environment with the business tools you need. Combo is also packed with practical stowage solutions that make light work of organising your cab.





# A PRACTICAL PERSPECTIVE

**Reduce your overheads and increase your potential for growth.** With its high capacity and low running costs, Combo really can give your business a competitive edge. At the business end, a range of custom-fit options allows you to transport all manner of loads, efficiently and safely – from parcels and pipes to ladders. With a massive 5.0cu.m of loadspace volume and a payload of up to a tonne, the new L2 H2 van can handle even larger items. Even with heavy machinery on board, the handling stays sharp and the ride comfortable. And with an L2 version of the Crew van available there's ample loadspace available even with up to five occupants on board. All of which means that Combo appeals more than ever to today's business user.





VX\_N\_COM\_18394.tif

**Instant access.** Combo is big on convenience. Offside and nearside sliding side-access doors are fitted to all long wheelbase and Crew van models; a nearside sliding side-access door is also standard on short wheelbase Sportive models. Together, the doors add even greater loading versatility to the van's load carrying potential, while allowing convenient access to cargo via the side of the vehicle. This is a particular benefit where the need arises for access to the offside of the vehicle. A glazed side door option is also available.



Combo

COMBO

Combo

# BUILT BY EXPERTS FOR EXPERTS



**Whatever your trade, there's a Combo that gets the job done.** With four distinct body styles – offering a choice of two GVW's, long or short wheelbases with high or standard roof and the versatile Crew van variants – the Combo range lets you select the configuration that's the exact fit for your business, meeting your requirements more closely than any previous Combo model. In addition the un-glazed Combo Crew van is officially classified as a Commercial Vehicle for VAT purposes meaning that as a business you can reclaim the VAT\*. And whichever version you choose, our design experts have ensured that your Combo will always be fit for purpose – a factor reinforced by a wide range of options and accessories. So whichever way you look at it, choosing Combo is a win-win decision.

\*Subject to the rules applicable to VAT recovery (not available on glazed Crew van).

## ➤ LOADED WITH INNOVATION

At a massive 3.4cu.m for the short wheelbase, standard roof version, there's no mistaking Combo's cavernous load area. The cargo space will comfortably swallow everything from Euro pallets to plant equipment and heavy machinery. For even bigger items, there are high roof and long wheelbase versions; combine both and you have an impressive 5.0cu.m of loadspace available while the maximum load height of high roof models is over 1.5m.

The practical Crew van extends that versatility even further with L2 models offering 1.9cu.m of loadspace and a load floor length of over 1.3m with the rear bench seat in place. Adding to the Combo's appeal is a wide range of load area options – including a handy load flap and internal ladder carrier – which let you exploit Combo's remarkable carrying potential to the full.





**Load up.** Open the rear doors and you're looking at a record holder. Quite simply, the Combo has the biggest payload in its class. It also boasts one of the longest and most spacious cargo areas plus a low rear loading height, so there's less risk of straining your back while working.

**1. Full-height bulkhead\*.** A full-height steel bulkhead – with optional glazing **2.** – provides valuable protection against shifting loads, while glazed rear door options enhance rear visibility. A protective ladder frame behind the rear seats is available on Crew van models at no extra cost.

**3. Rear side panel storage\*.** A storage bin located above the rear wheel arch provides handy stowage for loose items.

**4. Load flap\*.** The optional load flap is ideal for accommodating extra long or tall items. Simply unfasten the latch located underneath the flap and the rear section opens, up to an angle of 46°. This provides a handy 916mm x 503mm aperture.

**5. Ladder carrier\*.** Fit these optional bars in your panel van and you can fix a foldable ladder out of sight under the roof where it won't get in the way of your other gear.

\*Not available on Crew van models.

# > ALL SORTED

From a practicality perspective the Combo has everything sorted. A host of clever in-cab storage features make light work of organising your cab for a busy day out on the road. Sportive, Crew van and all high roof models also feature a cross cab overhead storage shelf. A choice of rear door applications with an extra-low loading height completes the picture.





**1. Asymmetrical rear doors.** Combo comes with asymmetrical rear doors as standard, which can be specified glazed. **2.** H1 models can also be ordered with a glazed tailgate option\*. Both extra cost, the glazing options feature wiper(s) and heated rear window, and must be ordered in conjunction with the glazed bulkhead option. The standard offer can be the more practical proposition when access to the load area through the rear doors is limited (for example, when operating in tight space). In both instances, the extra-low sill height (just 545mm) makes for ease of loading and unloading.

**3.4.5. Practical storage features.** Combo is full of practical storage features to assist with keeping the cabin safe and tidy, such as a recessed storage facility in the upper fascia, lockable glovebox and door pockets.

**6. Overhead storage shelf.** Sportive, Crew van and all high-roof models feature an overhead storage shelf that's ideal for holding folders, worksheets and items you need close at hand.

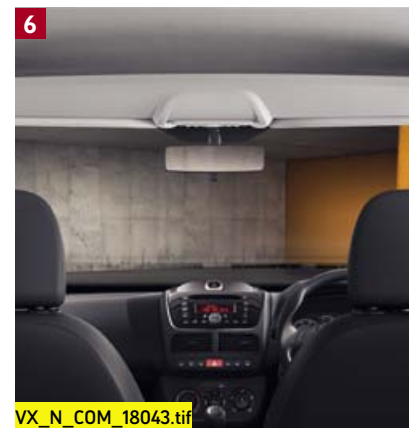

\*Glazed tailgate is standard-fit on glazed Crew van models, unavailable on unglazed Crew vans.

## ➤ EASY DOES IT

From the ergonomically designed facia and fully adjustable driver's seat through to electric windows and air conditioning, the Combo range is simply packed with features designed to make the driver's day more comfortable. Options like cruise control, rear parking distance sensors and electronic climate control further enhance driver well-being. The result: a mobile working environment you really won't mind spending time in.





**1. Clean design.** Combo's fascia is clearly and simply laid out, with controls easy to reach and just as easy to operate. Switchgear is logical and the high-mounted driver's seat provides an excellent all-round view of the road.

**2. Electronic climate control (ECC).** Optional on Sportive models in conjunction with the Winter Pack, the ECC system features individual temperature controls for the driver and passenger. The Winter Pack itself comprises headlight washers, front fog lights, exterior temperature sensor and electrically heated adjustable door mirrors.

**3. Reach- and rake-adjustable steering.** Reach- and rake-adjustable steering is fitted as standard, ensuring a perfect driving position.

**4. Adjustable driver's seat.** Combo models feature a four-way adjustable driver's seat with adjustment fore and aft plus tilt. The six-way adjustable 'Comfort' driver's seat (illustrated right) on Sportive models adds height and lumbar adjustment plus a handy armrest.

# SAFE AND SOUND

Safety in the workplace is a vital concern for any business and Combo is no exception. The protection starts with a sturdy passenger cell made of high-grade steel, plus an airbag for the driver and ABS with electronic brakeforce distribution. Key safety options include driver aids like ESP with hill start assist and rear parking distance sensors, along with passenger and side-impact airbags.

An informed driver is a safer driver, so Combo can also be specified with an optional CD/MP3 CD player/stereo radio, along with wireless Bluetooth® connectivity for ease of communication on the move and provision for a satellite navigation system to keep you heading in the right direction.

**1. Hill start assist.** Maintains the brake pressure for a short period after the brake pedal has been released when pulling away on a gradient of 5% or more; this helps prevent the vehicle from rolling back. The pressure is released as soon as the driver presses the accelerator and the vehicle begins to move forward. This ensures improved hill starting for increased comfort and safety. Optional on all models.

**2. Rear parking distance sensors.** Optional rear parking distance sensors provide an audible warning to help prevent accidental damage when parking or reversing.

**3. Four airbags.** A driver's airbag is standard on all models with the option to add a passenger airbag and side-impact airbags for improved protection in the event of a collision.

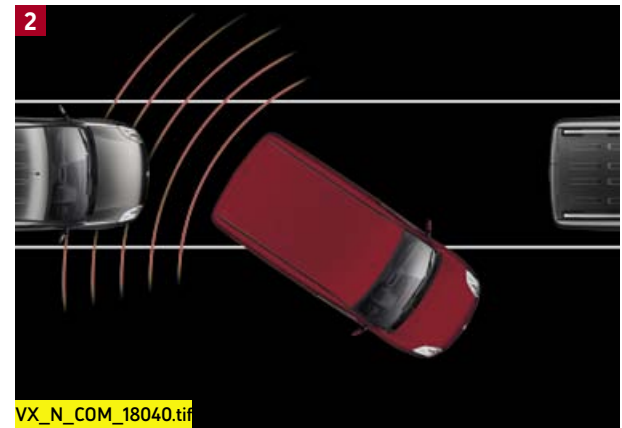
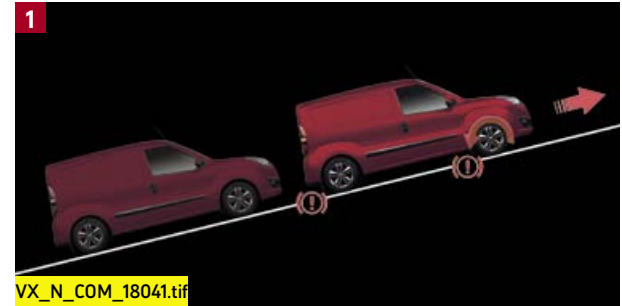



**Driver Pack.** Drivers looking to create the ultimate working environment can specify the optional Driver Pack at extra cost. The pack comprises a CD/MP3 CD player/stereo radio with Bluetooth® connectivity, aux-in socket, USB port, steering wheel mounted audio controls, leather-covered steering wheel and gear knob (manual models only) along with pre-installation for a TomTom navigation system.

**4. Steering wheel-mounted audio controls.** Allows you to access all the functions of the optional CD 50 unit without taking your eyes off the road – or your hands off the wheel. You can adjust speaker volume and the text message read-out, accept incoming calls or set voice recognition and stereo options.

**5. Aux-in socket and USB port.** Conveniently situated for optimum ease of use, the optional aux-in and USB port enable drivers to connect their mobile devices and so access a range of multimedia files, including MP3, MP4 and WMA.

**6. CD 50 with multimedia reader.\*** This optional hands-free system incorporates Bluetooth® technology, an SMS message reader and a CD/MP3 CD player/stereo radio. It can access MP3 players and other devices via the aux-in socket and USB port.

**TomTom pre-installation kit.** Also part of the Driver Pack, provides the essential wiring for a TomTom navigation system (navigation system not included).

\*Also available as a separate option.

# ➤ POWER AND EFFICIENCY

How well a vehicle holds a load is one thing.  
How well it shifts that load is another...

When it comes to everyday driving, Combo's bi-link independent rear suspension gives you the best possible ride quality and handling – even when you're hauling heavy loads. But Combo doesn't only ride and handle like a dream; it also performs with remarkable verve for what is, to all intents and purposes, a working vehicle. Drivers can select from four powerful yet efficient Euro 5 compliant turbo-diesel engines and a 1.4i 16v (95PS) Start/Stop petrol unit. All five engines are designed for optimum ease of serviceability and low running costs. The diesel range comprises 1.3CDTi 16v (90PS), 1.3CDTi 16v (90PS) ecoFLEX Start/Stop,

1.6CDTi 16v (105PS) Start/Stop and 2.0CDTi 16v (135PS) units. There is also a 1.6CDTi 16v (90PS) version complete with Start/Stop and Tecshift transmission. Start/Stop switches the engine off when you stop at the lights or in traffic, then restarts it once the clutch is depressed, cutting fuel bills and reducing emissions. A choice of ecoFLEX models further underlines Vauxhall's 'eco' credentials, while Combo drivers can also look forward to long service intervals (two years/21,000 miles\*) and excellent fuel consumption for the 1.3CDTi 16v (90PS) ecoFLEX engine with Start/Stop.

## ENGINES AND TRANSMISSIONS

	Urban driving	Fuel economy mpg (litres/100km) <sup>#</sup> Extra-urban driving	Combined figure	CO <sub>2</sub> emissions <sup>#</sup> (g/km)
<b>Petrol</b>				
<b>1.4i 16v (95PS) Start/Stop</b>	29.1 (9.7) – 30.7 (9.2)	47.9 (5.9) – 49.6 (5.7)	38.7 (7.3) – 40.3 (7.0)	168 – 163
<b>Diesel</b>				
<b>1.3CDTi 16v (90PS)</b>	42.8 (6.6) – 43.5 (6.5)	65.7 (4.3) – 67.3 (4.2)	55.4 (5.1) – 56.5 (5.0)	136 – 133
<b>1.3CDTi 16v (90PS) ecoFLEX Start/Stop</b>	47.1 (6.0) – 47.9 (5.9)	65.7 (4.3) – 67.3 (4.2)	57.6 (4.9) – 58.9 (4.8)	129 – 126
<b>1.6CDTi 16v (90PS) Start/Stop Tecshift</b>	49.6 (5.7) – 51.4 (5.5)	52.3 (5.4) – 61.4 (4.6)	51.4 (5.5) – 57.6 (4.9)	145 – 130
<b>1.6CDTi 16v (105PS) Start/Stop</b>	44.1 (6.4) – 46.3 (6.1)	53.3 (5.3) – 61.4 (4.6)	49.5 (5.7) – 54.3 (5.2)	150 – 136
<b>2.0CDTi 16v (135PS)</b>	38.7 (7.3)	54.3 (5.2)	47.1 (6.0)	158

For full model availability please refer to the equipment and technical data section. \*Or oil-life quality monitor warning whichever is the sooner (two years/18,000 miles for 1.4i 16v petrol engine).

<sup>#</sup>Official Government Test Environmental Data. Official EU-regulated test data is provided for comparison purposes and actual performance will depend on driving style, road conditions and other non-technical factors.

**Tecshift transmission.** Tecshift offers all the main features and flexibility of a regular automatic, plus the performance and control of a 'one-touch' manual gearbox.



VX\_N\_COM\_18039.tif



Sportive model illustrated features roof rails and 16-inch alloy wheels, optional at extra cost.

VX\_N\_COM\_19583.tif

# THE COMBO COLLECTION

Whatever your line of business, whatever cargo you're carrying, there's a Combo to suit all operators – and all budgets – including the new L2 H2 variant and versatile Crew van models. The choice is entirely down to you. Here's a brief overview of the wide range of models available.

To help you select the Combo that's just right for your business, we've adopted a straightforward naming scheme. L stands for Length: there are two versions available, L1 (short wheelbase) and L2 (long wheelbase). Height (H) comes in two sizes, H1 (standard roof) and H2 (high roof). For details of the complete model line-up, please refer to the Combo Price Guide available from your Vauxhall retailer or online at: [www.vauxhall.co.uk](http://www.vauxhall.co.uk)

## Standard or high roof.

The high roof adds an extra 245mm compared to the standard version.

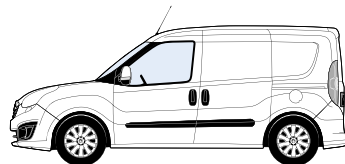
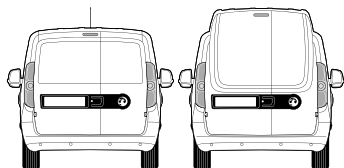

**L1 H1 Panel van: Short wheelbase, standard roof.** The consummate all-rounder, with up to 3.4cu.m of loadspace. Note: the load area is one of the widest and longest in its class.

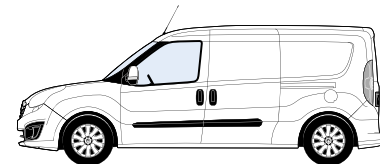

**L2 H1 Panel van: Long wheelbase, standard roof.** The 3.1m wheelbase gives you up to 4.2cu.m of cargo volume.

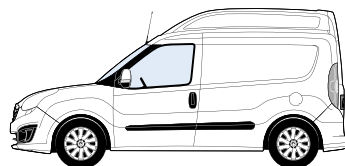

**L1 H2 Panel van: Short wheelbase, high roof.** Go up in size with 4.0cu.m of loadspace.

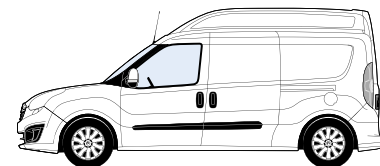

**L2 H2 Panel van: Long wheelbase, high roof.** The high and the mighty with 5.0cu.m of loadspace.

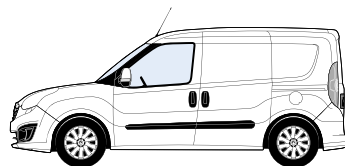

**L1 H1 Crew van: Short wheelbase, standard roof.** The ability to seat five without compromising load carrying potential.

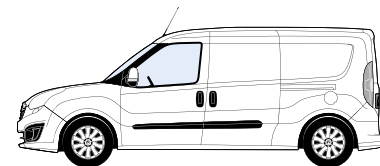

**L2 H1 Crew van: Long wheelbase, standard roof.** Ultimate versatility. Carry up to five or up to 1.0cu.m of cargo volume with the seats folded up.





**Crew van, maximum versatility.** Both Crew van models feature easy access to the rear seats via twin sliding side-access doors. A 60/40 split-folding rear seat arrangement means maximum versatility too. A ladder frame bulkhead is optional at no extra cost.

**A choice of rear doors.** All Combo panel vans and the unglazed Crew van come with asymmetrical rear doors as standard or can be ordered with a tailgate option complete with a wiper and a heated rear window as an extra cost option\*.

**Glazing options\*\*.** Fixed glazed windows for the nearside sliding side-access door and opposite panel or door are available as an extra cost option. In addition, the standard, unglazed asymmetric rear doors are available glazed as an extra cost option and come complete with wipers and heated rear windows. In addition glazed Crew van models are now available featuring fixed glazed side windows and a glazed tailgate as standard.

\*Standard on glazed Crew van, not available on H2 panel vans or unglazed Crew van.

\*\*Not available on unglazed Crew van.

LOAD AREA DIMENSIONS				
	L1 H1	L1 H2	L2 H1	L2 H2
<b>Loadspace mm (inches)</b>				
Maximum length – Panel van	1820 (71.7)		2170 (85.4)	
Maximum length – Crew van with seats up	991 (39.0)	–	1341 (52.8)	–
Maximum length – Crew van with seats down	1400 (55.1)	–	1750 (68.9)	–
Maximum width	1714 (67.5)			
Maximum width between wheel arches	1230 (48.4)			
Maximum height	1305 (51.4)	1550 (61.0)	1305 (51.4)	1550 (61.0)
<b>Side and rear load door dimensions mm (inches)</b>				
Side door aperture height	1175 (46.2)			
Side door aperture width	700 (27.5)			
Rear door aperture height	1250 (49.2)	1455 (57.2)	1250 (49.2)	1455 (57.2)
Rear door aperture width	1231 (48.5)			
<b>Loading heights (unladen) mm (inches)</b>				
	545 (21.4)			
<b>Loadspace volumes cu.m (cu.ft.)</b>				
Panel van	3.4 (121)	4.0 (141)	4.2 (148)	5.0 (177)
Crew van with seats up (to top of seats)	0.8 (28.2)	–	1.0 (35.3)	–
Crew van with seats up (to roof)	1.4 (49.4)	–	1.9 (67.1)	–
<b>Weights and towing (kg)†</b>				
Maximum payloads	705 – 1000			
Maximum gross combination weights	2990 – 3500			

†See pages 44-47 for full details of weights and towing data.

# COMBO

Known simply as Combo, the base panel van model features stylish good looks while providing a well-equipped and cost-efficient introduction to the line-up.

## Standard features include:

- Anti-lock Braking System with electronic brakeforce distribution
- Driver's airbag
- Seatbelt pretensioner system
- Remote control central deadlocking
- Lockable fuel filler cap
- Electronic engine deadlock immobiliser
- Lockable glovebox
- CD player/radio with four 20-watt speakers
- Reach and rake-adjustable steering column
- Reach and rake-adjustable seats
- Cube cloth seat trim
- Overhead shelf (H2 models only)
- Electrically operated front windows
- Body side-protection mouldings
- Windscreen wipers with variable intermittent facility
- Unglazed asymmetric rear doors
- Full-height steel bulkhead
- Load restraint lashing eyes
- Illuminated load area
- Nearside/offside sliding side-access doors (L2 models only)
- 15-inch steel wheels with centre covers (2000 models)
- 16-inch steel wheels with centre covers (2300 models)





VX\_N\_COM\_18392.tif

Combo 1.6CDTi 16v Start/Stop Tecshift model illustrated left features vinyl seat trim, optional at extra cost.

AVAILABILITY	L1 H1		L1 H2		L2 H1	L2 H2
	2000	2300	2000	2300	2300	2300
1.4i 16v (95PS) Start/Stop	•	–	–	–	•	–
1.3CDTi 16v (90PS)	•	•	–	–	•	–
1.3CDTi 16v (90PS) ecoFLEX Start/Stop	•	•	–	–	•	–
1.6CDTi 16v (90PS) Start/Stop Tecshift	•	•	•	•	•	•
1.6CDTi 16v (105PS) Start/Stop	•	•	•	•	•	•



VX\_N\_COM\_18062.tif

VX\_N\_COM\_18097.tif



VX\_N\_COM\_18063.tif

**1. Reach- and rake-adjustable steering.**

Reach- and rake-adjustable steering is fitted as standard, ensuring a perfect driving position.

**2. Electric windows and central door locking.**

Electric windows and central door locking are also standard, promoting security, comfort and convenience. The central locking system features security deadlocks for added protection.

# ➤ CREW VAN

**This versatile model offers five-seater capacity for many working uses. Glazed models are now also available.**

**Standard features include:**

- Anti-lock Braking System with electronic brakeforce distribution
- Driver's airbag
- Seatbelt pretensioner system
- Remote control central deadlocking
- Lockable fuel filler cap
- Electronic engine deadlock immobiliser
- Lockable glovebox
- CD player/radio with four 20-watt speakers
- Reach and rake-adjustable steering column
- Reach and rake-adjustable front seats
- Cube cloth seat trim
- Overhead shelf
- Electrically operated front windows
- Body side-protection mouldings
- Windscreen wipers with variable intermittent facility
- Unglazed asymmetric rear doors – unglazed models
- Glazed tailgate with wash/wipe facility and heated rear window – glazed models
- Rear seat with 'fold and tumble' facility and 60/40 split seat back and cushion
- Load restraint lashing eyes
- Illuminated load area
- Nearside and offside sliding side-access doors
- 16-inch steel wheels with centre covers



Protective ladder frame illustrated is a no-cost option.



CREW VAN AVAILABILITY	L1 H1	L2 H1
	2300	2300
1.3CDTi 16v (90PS)	•	•
1.3CDTi 16v (90PS) ecoFLEX Start/Stop	•	•
1.6CDTi 16v (105PS) Start/Stop	•	•

VX\_N\_COM\_19938.tif

L2 H1 model illustrated.



VX\_N\_COM\_19942.tif



VX\_N\_COM\_19940.tif

### 1. Protective ladder frame.

A protective ladder frame which fits behind the second-row seats is available as a no-cost option.

### 2. Rear side panel storage.

L1 H1 models feature a fully trimmed load area side panel complete with useful storage. Both models feature a 12-volt accessory socket in the load area.

# COMBO SPORTIVE

**Sportive models combine additional driver comfort with a highly individual style. The Sportive Crew van is new to the Combo line-up.**

## **Additional features over and above**

### **Combo models:**

- Air conditioning
- Height-adjustable driver's seat with armrest and lumbar support
- Overhead shelf
- Soundproofed bulkhead
- PVC load floor covering
- Nearside sliding side-access door (L1 models only)
- Body-colour front and rear bumpers
- Body-colour exterior door mirrors
- Metallic paint
- 15-inch steel wheels with full-diameter wheel trims (1.3CDTi and 1.6CDTi 2000 models)
- 16-inch steel wheels with full-diameter wheel trims (2.0CDTi and 2300 models)

### **Sportive Crew van models also feature:**

- Unglazed asymmetric rear doors
- Rear seat with 'fold and tumble' facility and 60/40 split seat back and cushion
- Nearside and offside sliding side-access doors



SPORTIVE AVAILABILITY	L1 H1		L1 H2		L2 H1
	2000	2300	2000	2300	2300
1.3CDTi 16v (90PS)	•	•	-	-	•
1.3CDTi 16v (90PS) ecoFLEX Start/Stop	•	•	-	-	•
1.6CDTi 16v (105PS) Start/Stop	•	•	•	•	•
2.0CDTi 16v (135PS)	•	•	-	-	-

SPORTIVE CREW VAN AVAILABILITY	L1 H1	L2 H1
	2300	2300
1.3CDTi 16v (90PS)	•	•
1.3CDTi 16v (90PS) ecoFLEX Start/Stop	•	•
1.6CDTi 16v (105PS) Start/Stop	•	•



VX\_N\_COM\_21155.psd

2.0CDTi 16v (135PS) model illustrated. Passenger and side-impact airbags are optional at extra cost.



VX\_N\_COM\_18043.tif

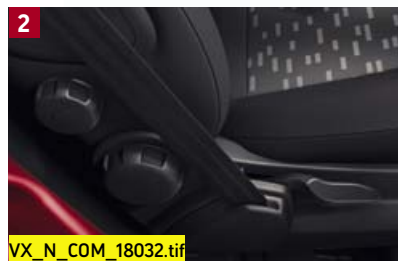

VX\_N\_COM\_18032.tif

### 1. Overhead storage shelf.

Handy overhead storage shelf creates valuable additional stowage space for odds and ends and loose items.

### 2. Height-adjustable driver's seat.

Six-way adjustable seat features adjustment fore and aft plus tilt and height adjustment, armrest and lumbar support.

# ➤ OPTIONS AND ACCESSORIES

Vauxhall options and accessories are all about choice – selecting your Combo then personalising it to suit the way you work. There's a choice of factory-fitted options and a huge range of Genuine Vauxhall Accessories – all designed and manufactured to the same exacting standards as the van itself. For further information please ask your Vauxhall Commercial Vehicle retailer.

## OPTION PACKS:

### Driver Pack.

For details see page 21.

### Load Compartment Pack.

- 12-volt accessory socket in load area **1.**
- Removable courtesy light in load area **2.**
- Overhead shelf **3.**

### Winter Pack.

- Headlight washers
- Front fog lights **4.**
- Exterior temperature sensor
- Electrically adjustable/heated door mirrors **5.**

## INDIVIDUAL OPTIONS INCLUDE:

- Active-safety head restraints
- Alarm pre-installation kit
- Third key/third key with remote control
- Air conditioning
- Electronic climate control
- Cruise control
- Height-adjustable driver's seat with armrest and lumbar support
- Rear parking distance sensors
- Roof rails (H1 models only)
- Protective ladder-frame behind driver in lieu of full-height steel bulkhead
- Up-rated alternator
- 16-inch alloy wheels (Sportive only)
- Winter tyres





Genuine Vauxhall Accessories are the right choice for your Combo. Whatever your business requirement there's certain to be a Vauxhall accessory that fits your need, all fitted by trained Vauxhall professionals. The products shown here are just a small sample of the range available. For a full list, please refer to the Combo Price Guide or visit our website at: [www.vauxhall.co.uk/accessories](http://www.vauxhall.co.uk/accessories)

**6. Roof base carrier.** Our roof rack system begins with this versatile base carrier, comprising three lockable T-track bars. Compatible with a wide range of Thule attachments. Easy to fit and remove.

**7. Roof rack tray.** Ensures all items carried on the roof are kept safe and secure. Features a load roller to assist in loading heavy and/or long items.

**8. Thule ladder tilt and side profiles with load stop.** A special extension bar reaches down over the side of the van so you can quickly load and unload a ladder without stretching. The side profiles with load stop enable large diameter loads of over three metres to be carried safely. Strong ratchet tie downs are provided with both systems.

**9. Rear window protection grilles.** Help avoid theft while retaining rearward visibility. Can also prevent incidental damage caused by shifting loads.

**10. Load area protection panels.** Shaped to fit over the floor and side panels to protect the load area.

**Towing bar.** We offer a wide choice of tow bars, from fixed and removable designs to heavy-duty tow hooks and flange balls.

Not all of the options and accessories described are available on every model. So please check the equipment and technical data section and Combo Price Guide for further details.



# COLOURS AND TRIMS

Combo's business-like appearance is exemplified by the smart choice of colours available. The cloth or vinyl trims have been chosen as much for their hard-wearing properties as they have for their strong visual appeal.

Due to the limitations of the printing process, the colours reproduced may vary slightly from the actual paint colour and trim material. As a result, they should be used as a guide only. Your Vauxhall retailer has a comprehensive display of our paint samples.

## SOLID



VX\_COM\_21162.tif

Polar White



VX\_COM\_21163.tif

Tomato Red



VX\_COM\_21164.tif

Deep Blue

## TWO-COAT METALLIC\*



VX\_COM\_21156.tif

Magnetic Silver



VX\_COM\_21158.tif

Twilight Blue



VX\_COM\_21160.tif

Midnight Black



VX\_COM\_21157.tif

Ruby Red



VX\_COM\_21159.tif

Marine Blue



VX\_COM\_21161.tif

Pepperdust



VX\_N\_COM\_18017.tif

**Black vinyl\*\*.** Black vinyl trim can be specified at extra cost for customers requiring a more workmanlike, wipe-clean alternative to cloth.

### TRIMS



VX\_N\_COM\_17533.tif

Cube Cloth

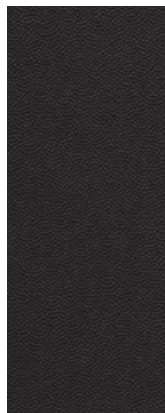

VX\_N\_COM\_17534.tif

Vinyl\*\*

### EXTERIOR COLOURS

	Trim name and trim colour	
	Cube Cloth	Vinyl**
<b>Solid</b>		
<b>Polar White</b>	Black	Black
<b>Tomato Red</b>	Black	Black
<b>Deep Blue</b>	Black	Black
<b>Two-coat metallic*</b>		
<b>Ruby Red</b>	Black	Black
<b>Twilight Blue</b>	Black	Black
<b>Marine Blue</b>	Black	Black
<b>Magnetic Silver</b>	Black	Black
<b>Midnight Black</b>	Black	Black
<b>Pepperdust</b>	Black	Black

\* = Optional at extra cost on Combo models. No cost option on Sportive models.

\*\* = Vinyl trim optional at extra cost on Combo models only. Not available on Sportive or Crew van models.

# THE WHEELS OF YOUR BUSINESS

Whatever your load, Vauxhall Commercial Vehicles are designed to help you deliver a top quality job. Our award-winning line-up can actively enhance the operating efficiency of your business by delivering outstanding load-carrying potential, low running costs and day-long driver comfort.

Whichever Vauxhall Commercial Vehicle you choose, you can rest assured that Vauxhall's nationwide network of retailers will go the extra mile to meet all your servicing and maintenance needs.

But why take our word for it? Vauxhall's commitment to keeping your business moving is recognised by van operators of all sizes across the length and breadth of the country...



VX\_COV\_16060.tif

**Mike Sinclair, Senior Property Partner,  
Aberdeen Considine said...**

*'Our fleet of 23 Corsavan Sportives is a reflection on our business, reinforcing our professional image. Not only that, we've found them economical, reliable and fun to drive.'*



VX\_ASV\_15991.tif

**Andrew Cook, Rail Structures Examiner,  
Amey PLC said...**

*'The reasons I drive Vivaro? Simple. It's comfortable, the driving position and visibility are great and it's surprisingly compact. This makes it ideal for some of the limited access situations we encounter.'*



VX\_VIV\_15654.tif

**Russell Lelliot, Managing Director,  
RSL Transport said...**

*'We've been running Movanos for years. Our two new Movanos save around 4mpg when full, compared to the old models. Which over almost 3000 miles per week per van, is a big saving!'*



VX\_N\_COM\_19410.tif

**Richard Fox, Managing Director, ITE Projects said...**

*'Our flexible and fast paced approach to our projects is well served by the Combo van, with an impressive payload capacity it is able to carry crucial equipment to our clients' sites. We rely totally on our vehicles to ensure we are available 24/7 to service our customers' critical requirements. The Combo van is proving to be as reliable as we are.'*



**WINNER**  
Combo  
Light Van  
of the Year



## Contents

### Equipment

Safety	38
Security	
Facia, instruments and controls	
Seating	39
Audio, communication and navigation	
Interior	
Mechanical	40
Exterior	
Load area	
Wheels and tyres	41
Option packs	
Tyre rating	
Vauxhall Assistance	
<b>Technical data</b>	
Engines	42
Transmission ratios	
Fuel economy and emissions, transmissions, steering, suspension, electrics, brakes, fuel tank capacity, body and insurance groups	43
L1 Dimensions, weights and towing data	44
L2 Dimensions, weights and towing data	46

## Safety

**Standard features** • Daytime running lights • Anti-lock Braking System (ABS) with electronic brakeforce distribution • Emergency brake assist – Increases applied brake force in emergency braking situations • Driver's airbag • Height-adjustable head restraints • Height-adjustable front seatbelts • Inertia-reel lap and diagonal seatbelts • Seatbelt pretensioner system – Tightens the seatbelt during the early stages of a frontal impact • Front seatbelt force limiters – Reduces potential upper body injuries during a frontal impact • Side-impact protection beams • Laminated windscreen • Fire prevention system with fuel cut-off • Centre brake light

### Additional features

	Combo	Combo Sportive	Crew van	Crew van Sportive
Front passenger's airbag with deactivation switch	<input type="radio"/>	<input type="radio"/>	<input type="radio"/>	<input type="radio"/>
Front passenger's airbag with driver and passenger's side-impact airbags	<input type="radio"/>	<input type="radio"/>	<input type="radio"/>	<input type="radio"/>
Active-safety head restraints (front seats only)	<input type="radio"/>	<input type="radio"/>	<input type="radio"/>	<input type="radio"/>
Electronic Stability Programme (ESP) with hill start assist and anti-slip regulator traction control	<input type="radio"/>	<input type="radio"/>	<input type="radio"/>	<input type="radio"/>

## Security

**Standard features** • Remote control central deadlocking • Electronic engine deadlock immobiliser • Electronic theft protection for audio equipment • 'Key left in ignition' audible warning • Lockable glovebox • Lockable fuel filler cap

### Additional features

	Combo	Combo Sportive	Crew van	Crew van Sportive
Alarm pre-installation kit <sup>1</sup>	<input type="radio"/>	<input type="radio"/>	<input type="radio"/>	<input type="radio"/>
Third key	<input type="radio"/>	<input type="radio"/>	<input type="radio"/>	<input type="radio"/>
Third key with remote control	<input type="radio"/>	<input type="radio"/>		

## Facia, instruments and controls

**Standard features** • Trip computer – provides information on overall distance, trip distance, average and instantaneous fuel consumption, remaining range, distance and average speed since last reset • Trip odometer • Rev counter • Electronically controlled coolant temperature gauge and fuel gauge with low fuel level warning light • Service-due indicator • 12-volt accessory socket • Digital clock • Reach and rake-adjustable steering column • Lidded glovebox • Dipping rear-view mirror (when glazed bulkhead and glazed rear doors/tailgate are specified) • Storage compartment on driver's side facia

### Additional features

	Combo	Combo Sportive	Crew van	Crew van Sportive
Cruise control	<input type="radio"/>	<input type="radio"/>	<input type="radio"/>	<input type="radio"/>
Leather-covered steering wheel	<input type="checkbox"/>	<input type="checkbox"/>	<input type="checkbox"/>	<input type="checkbox"/>
Leather-covered gear knob (manual models)	<input type="checkbox"/>	<input type="checkbox"/>	<input type="checkbox"/>	<input type="checkbox"/>

## Seating

**Standard features** • Cube cloth seat trim • Reach and rake-adjustable driver and front passenger's seat

### Additional features

	Combo	Combo Sportive	Crew van	Crew van Sportive
Vinyl seat trim <sup>2</sup>	○			
Height-adjustable driver's seat with armrest and lumbar support	○ <sup>2</sup>	●	○	●
Front passenger's seat with under cushion storage compartment	○ <sup>2</sup>	○		
Rear seat with 'fold and tumble' facility and 60/40 split seat back and cushion			●	●

## Audio, communication and navigation

### Features

	Combo	Combo Sportive	Crew van	Crew van Sportive
<b>CD player/stereo radio</b> • CD player • AM/FM stereo radio with 24 station presets • RDS with Traffic Programme • Four 20-watt speakers	●	●	●	●
<b>CD 50 multimedia</b> • CD/MP3 CD player • Bluetooth® connectivity for compatible mobile phones • Aux-in socket • USB connectivity • AM/FM stereo radio with 24 station presets • RDS with Traffic Programme • Steering wheel mounted audio controls • Four 20-watt speakers	○	○	○	○
Pre-installation for TomTom navigation system (excludes sat nav) <sup>3</sup>	□	□	□	□
Flexible roof-mounted aerial	●	●	●	●

## Interior

**Standard features** • Cabin interior courtesy light operated by door switches • Four-speed air blend heater • Two coat hooks • Door armrests • Overhead shelf (H2 models) • Door storage pockets • Twin sunvisors, front passenger's with vanity mirror • Vinyl floor covering in cabin area • Passenger assist handle

### Additional features

	Combo	Combo Sportive	Crew van	Crew van Sportive
Air conditioning	○	●	○	●
Electronic climate control incorporating air conditioning (mandates Winter Pack at extra cost)		○		
Overhead shelf (H1 models)	□	●	●	●
Cigar lighter and removable ashtray	□	□	□	□
Soundproofed bulkhead		●		



CD 50 multimedia.



Air conditioning and air recirculation.

- = Standard equipment.
- = Optional at extra cost.
- = Only available as part of an extra-cost option pack.

- 1 = Accessory alarm available at extra cost.
- 2 = Vinyl seat trim is unavailable in conjunction with height-adjustable driver's seat or front passenger's seat with under cushion storage.
- 3 = Accessory sat nav available at extra cost.



Internal ladder storage bars.

- = Standard equipment.
- = Optional at extra cost.
- N/C = No-cost option.
- = Only available as part of an extra-cost option pack.

- 3 = Accessory sat nav available at extra cost.
- 4 = Optional on L1 2300 models only.
- 5 = Not available with rear roof flap.
- 6 = Special paint available at extra cost. Please consult your retailer for details. Restrictions apply and minimum quantity may be required. Fleet customers should contact their Vauxhall fleet sales manager.
- 7 = Only available when glazed rear doors or tailgate are specified.
- 8 = In lieu of full-height steel bulkhead on Panel van.
- 9 = Only available with Load Compartment Pack.
- 10 = The unglazed Combo Crew van is classified as a Commercial Vehicle (Category N) for VAT purposes and appears on HMRC's list of vans with rear seats. As such, businesses purchasing this vehicle may be able to reclaim the VAT subject to the usual rules surrounding VAT recovery. The glazed crew van is not pre-approved for VAT reclaimable status and it is advisable that customers consult their local HMRC Office or visit [www.hmrc.gov.uk](http://www.hmrc.gov.uk) for further details.
- 11 = Only available when full-height steel bulkhead with window is specified.
- 12 = Glazed crew van only.
- 13 = Not available with roof rails, glazed tailgate or full-size spare wheel.
- 14 = Not available with Load Compartment Pack or rear roof flap.

## Mechanical

**Standard features** • Front-wheel drive • Five-speed manual gearbox (1.4i/1.3CDTi) • Six-speed manual gearbox (1.6CDTi (105PS)/2.0CDTi) • Five-speed Tecshift transmission (1.6CDTi (90PS)) • Electric power-assisted steering

<b>Additional features</b>	Combo	Combo Sportive	Crew van	Crew van Sportive
Up-rated alternator	○	○	○	○
Up-rated front suspension (standard on L2 models)	○ <sup>4</sup>	○ <sup>4</sup>		

## Exterior

**Standard features** • Electrically operated front windows • Body side-protection mouldings • Black door mirrors • Windscreen wipers with variable intermittent facility and flick/wipe

<b>Additional features</b>	Combo	Combo Sportive	Crew van	Crew van Sportive
Front fog lights	○	○	○	○
Rear parking distance sensors	○	○	○	○
Roof rails (H1 models only) <sup>5</sup>	○	○		
Body-colour bumpers and exterior door mirrors		●		●
Two-coat metallic paint	○	●	○	●
Special paint <sup>6</sup>	○		○	

## Load area

**Standard features** • Load restraint lashing eyes (six) • Illuminated load area

<b>Additional features</b>	Combo	Combo Sportive	Crew van	Crew van Sportive
Full-height steel bulkhead	●	●		
Full-height steel bulkhead with window <sup>7</sup>	○	○		
Protective ladder frame behind driver (behind second row seats on Crew van) <sup>8</sup>	N/C <sup>9</sup>	N/C	N/C	N/C
PVC load floor covering	□	●		
Carpeted load floor covering			●	●
Rear side panel storage (fully trimmed L1, part trimmed L2) includes 12v accessory socket			●	●
Nearside sliding side-access door (standard on L2 models)	○	●		
Offside sliding side-access door (standard on L2 models)		○		
Nearside and offside sliding side-access doors (standard on L2 and all Crew vans)	○		●	●
Fixed windows in nearside sliding side-access door and opposite panel/door	○	○	○ <sup>10</sup>	
Unglazed asymmetric rear doors (90°/180°)	●	●		●
Glazed asymmetric rear doors with heated windows and wash/wipe facility <sup>11</sup>	○	○	○ <sup>12</sup>	
Glazed tailgate with heated window and wash/wipe facility (H1 models) <sup>11</sup>	○	○	● <sup>12</sup>	
Rear roof flap (L1 H1 models only) <sup>9,13</sup>	○	○		
Internal ladder storage bars <sup>14</sup>	○	○		





## Wheels and tyres

Features	Combo	Combo Sportive	Crew van	Crew van Sportive
15-inch steel wheels with centre covers and 185/65 R 15 tyres (2000 models)	●			
16-inch steel wheels with centre covers and 195/60 R 16 tyres (2300 models)	●			
15-inch steel wheels with full-diameter wheel trims and 185/65 R 15 tyres (1.3CDTi/1.6CDTi 2000 models)		●		
16-inch steel wheels with full-diameter wheel trims and 195/60 R 16 tyres (2.0CDTi/2300 models)		●	●	●
16-inch alloy wheels with 195/60 R 16 tyres		○		○
Winter tyres – Goodyear Ultragrip-7 195/65 R 15 (2000 models) or 195/60 R 16 (2300 models)	○			
Tyre inflation kit	●	●	●	●
Full-size spare wheel (in lieu of tyre inflation kit)	N/C	N/C	N/C	N/C

## Option packs

Additional features	Combo	Combo Sportive	Crew van	Crew van Sportive
<b>Driver Pack</b> • CD/MP3 CD player/stereo radio/Bluetooth® connectivity for compatible mobile phones/aux-in socket/USB connectivity/RDS with Traffic Programme/steering wheel mounted audio controls • Leather-covered steering wheel • Leather-covered gear knob (manual models) • Pre-installation for TomTom navigation system (excludes sat nav) <sup>3</sup>	○	○	○	○
<b>Load Compartment Pack</b> • Overhead shelf • PVC load floor covering • 12-volt accessory socket in load area • Removable load area courtesy light	○			
<b>Winter Pack</b> • Headlight washers • Front fog lights • Exterior temperature sensor • Electrically adjustable/heated door mirrors		○		
<b>Smoker Pack</b> • Cigar lighter • Removable ashtray	○	○	○	○

## Tyre rating

Tyre size	Fuel efficiency group	Wet grip performance	External noise	
			Measured (dB)	Group
185/65 R 15	C-E	A-C	68-69	
195/65 R 15	E	E	68	
195/60 R 16	C-E	B-C	70-72	

Tyre rating according to EU Regulation 1222/2009



Sportive 15-inch full-diameter wheel trims.



Sportive 16-inch alloy wheels (optional).

## Vauxhall Assistance and warranties\*

Every new Combo comes with:

- A three-year vehicle warranty consisting of a one-year/unlimited mileage manufacturer's warranty and a second and third year manufacturer's warranty with a 60,000 miles limitation
- Vauxhall Assistance for 12 months from first registration
- Six years' body panel anti-perforation warranty

\* = Warranty is only available on vehicles sourced from General Motors UK Limited. Terms and conditions apply – please see your Vauxhall retailer for details.

Power and torque curves

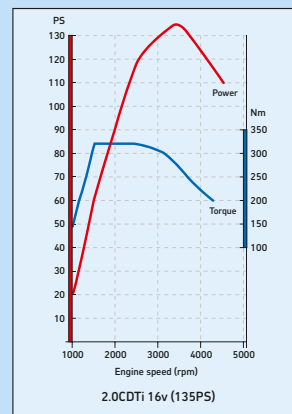
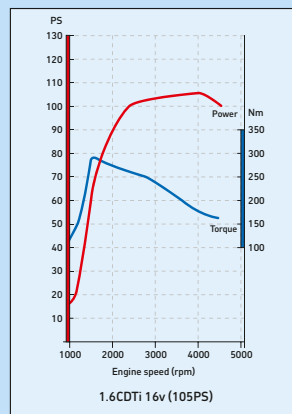
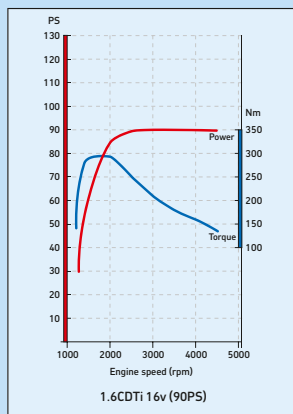
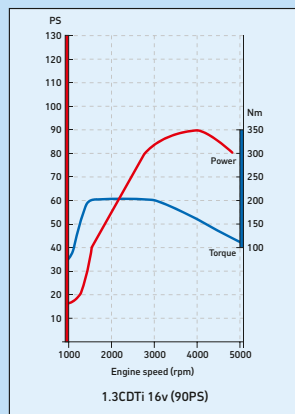
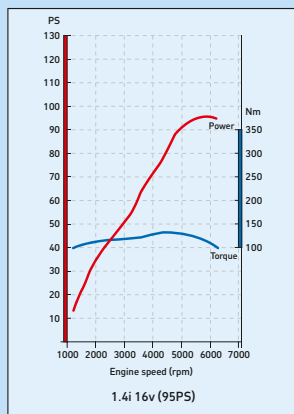

Engines

	1.4i 16v (95PS) with Start/Stop	1.3CDTi 16v (90PS) with or without Start/Stop	1.6CDTi 16v (90PS) with Start/Stop	1.6CDTi 16v (105PS) with Start/Stop	2.0CDTi 16v (135PS)
Fuel type	Petrol	Diesel	Diesel	Diesel	Diesel
Capacity	1368cc	1248cc	1598cc	1598cc	1956cc
Maximum power	95PS (70kW) @ 6000rpm	90PS (66kW) @ 4000rpm	90PS (66kW) @ 4000rpm	105PS (77kW) @ 4000rpm	135PS (99kW) @ 3500rpm
Maximum torque	127Nm (94 lb.ft.) @ 4500rpm	200Nm (148 lb.ft.) @ 1500rpm	290Nm (214 lb.ft.) @ 1500rpm	290Nm (214 lb.ft.) @ 1500rpm	320Nm (236 lb.ft.) @ 1500rpm
Configuration	4 cylinders, 4 valves per cylinder, double overhead camshafts				
Fuel/induction system	Multi-point fuel injection		Turbocharger with intercooler, Common rail fuel injection		
Service intervals	18,000 miles or two years (whichever occurs sooner)		21,000 miles or two years (whichever occurs sooner)		

Transmission ratios

	Gear ratios (mph/1000rpm)						Reverse	Final drive ratio
	1	2	3	4	5	6		
2000 1.4i 16v (95PS)	4.10:1 (3.5)	2.16:1 (6.7)	1.34:1 (10.7)	0.97:1 (14.8)	0.83:1 (17.3)	-	3.81:1	4.92:1
2000 1.3CDTi 16v (90PS)/1.6CDTi 16v (90PS)	4.27:1 (4.2)	2.24:1 (8.0)	1.44:1 (12.5)	1.03:1 (17.5)	0.79:1 (22.8)	-	3.91:1	3.93:1
2000 1.6CDTi 16v (105PS)	4.15:1 (4.4)	2.12:1 (8.7)	1.36:1 (13.6)	0.98:1 (18.8)	0.76:1 (24.3)	0.62:1 (29.8)	4.00:1	3.83:1
2000 2.0CDTi 16v (135PS)	4.15:1 (4.6)	2.12:1 (9.0)	1.36:1 (14.0)	0.98:1 (19.4)	0.76:1 (25.0)	0.62:1 (30.6)	4.00:1	3.83:1
2300 1.4i 16v (95PS)	4.10:1 (3.6)	2.16:1 (6.8)	1.34:1 (11.0)	0.97:1 (15.2)	0.83:1 (17.8)	-	3.81:1	4.92:1
2300 1.3CDTi 16v (90PS)/1.6CDTi 16v (90PS)	4.27:1 (4.3)	2.24:1 (8.3)	1.44:1 (12.9)	1.03:1 (18.0)	0.79:1 (23.4)	-	3.91:1	3.93:1
2300 1.6CDTi 16v (105PS)/2.0CDTi 16v (135PS)	4.15:1 (4.6)	2.12:1 (9.0)	1.36:1 (14.0)	0.98:1 (19.4)	0.76:1 (25.0)	0.62:1 (30.6)	4.00:1	3.83:1

## Fuel economy and emissions (all models)

	Fuel economy mpg (litres/100km)#			CO <sub>2</sub> emissions (g/km)#
	Urban driving	Extra-urban driving	Combined figure	
<b>L1 H1 Panel van</b>				
2000 1.4i 16v (95PS) S/S	30.7 (9.2)	49.6 (5.7)	40.3 (7.0)	163
2000 1.3CDTi 16v (90PS)	43.5 (6.5)	67.3 (4.2)	56.5 (5.0)	133
2000 1.3CDTi 16v (90PS) ecoFLEX S/S	47.9 (5.9)	67.3 (4.2)	58.9 (4.8)	126
2000 1.6CDTi 16v (90PS) S/S Tecshift	51.4 (5.5)	61.4 (4.6)	57.6 (4.9)	130
2000 1.6CDTi 16v (105PS) S/S	46.3 (6.1)	61.4 (4.6)	54.3 (5.2)	136
2000 2.0CDTi 16v (135PS)	38.7 (7.3)	54.3 (5.2)	47.1 (6.0)	158
2300 1.3CDTi 16v (90PS)	43.5 (6.5)	67.3 (4.2)	56.5 (5.0)	133
2300 1.3CDTi 16v (90PS) ecoFLEX S/S	47.9 (5.9)	67.3 (4.2)	58.9 (4.8)	126
2300 1.6CDTi 16v (90PS) S/S Tecshift	50.4 (5.6)	60.1 (4.7)	56.5 (5.0)	133
2300 1.6CDTi 16v (105PS) S/S	45.6 (6.2)	61.4 (4.6)	54.3 (5.2)	137
2300 2.0CDTi 16v (135PS)	38.7 (7.3)	54.3 (5.2)	47.1 (6.0)	158
<b>L1 H2 Panel van</b>				
2000 1.6CDTi 16v (90PS) S/S Tecshift	50.4 (5.6)	54.3 (5.2)	53.3 (5.3)	140
2000 1.6CDTi 16v (105PS) S/S	44.8 (6.3)	55.4 (5.1)	51.4 (5.5)	146
2300 1.6CDTi 16v (90PS) S/S Tecshift	50.4 (5.6)	54.3 (5.2)	53.3 (5.3)	140
2300 1.6CDTi 16v (105PS) S/S	44.8 (6.3)	55.4 (5.1)	51.4 (5.5)	146
<b>L1 H1 Crew van (with/without glazing)</b>				
2300 1.3CDTi 16v (90PS)	42.8 (6.6)	65.7 (4.3)	55.4 (5.1)	136
2300 1.3CDTi 16v (90PS) ecoFLEX S/S	47.1 (6.0)	65.7 (4.3)	57.6 (4.9)	129
2300 1.6CDTi 16v (105PS) S/S	43.3 (6.1)	60.1 (4.7)	54.3 (5.2)	138
<b>L2 H1 Panel van</b>				
2300 1.4i 16v (95PS) S/S	29.1 (9.7)	47.9 (5.9)	38.7 (7.3)	168
2300 1.3CDTi 16v (90PS)	42.8 (6.6)	65.7 (4.3)	55.4 (5.1)	136
2300 1.3CDTi 16v (90PS) ecoFLEX S/S	47.1 (6.0)	65.7 (4.3)	57.6 (4.9)	129
2300 1.6CDTi 16v (90PS) S/S Tecshift	50.4 (5.6)	60.1 (4.7)	56.5 (5.0)	133
2300 1.6CDTi 16v (105PS) S/S	45.6 (6.2)	61.4 (4.6)	54.3 (5.2)	137
<b>L2 H2 Panel van</b>				
2300 1.6CDTi 16v (90PS) S/S Tecshift	49.6 (5.7)	52.3 (5.4)	51.4 (5.5)	145
2300 1.6CDTi 16v (105PS) S/S	44.1 (6.4)	53.3 (5.3)	49.5 (5.7)	150
<b>L2 H1 Crew van (with/without glazing)</b>				
2300 1.3CDTi 16v (90PS)	42.8 (6.6)	65.7 (4.3)	55.4 (5.1)	136
2300 1.3CDTi 16v (90PS) ecoFLEX S/S	47.1 (6.0)	65.7 (4.3)	57.6 (4.9)	129
2300 1.6CDTi 16v (105PS) S/S	44.8 (6.3)	58.9 (4.8)	52.3 (5.4)	141

S/S = Start/Stop.

# = Official Government Test Environmental Data. Official EU-regulated test data is provided for comparison purposes and actual performance will depend on driving style, road conditions and other non-technical factors.

## Transmissions

- Front-wheel drive
- 1.4i 16v/1.3CDTi 16v: Five-speed manual
- 1.6CDTi 16v (105PS)/2.0CDTi 16v: Six-speed manual
- 1.6CDTi 16v (90PS): Five-speed Tecshift

## Steering

- Hydraulic power-assisted rack and pinion system
- Energy-absorbing steering column
- Kerb-to-kerb turning circle:  
L1: 11.2m (36.7ft.) L2: 12.5m (41.0ft.)

## Suspension

**Front:** Independent. MacPherson struts with coil springs, gas-pressure dampers and anti-roll bar.

**Rear:** Bi-link with coil springs, gas-pressure dampers and anti-roll bar.

## Electrics

### Alternator:

- 1.4i 16v/1.3CDTi 16v: 105A
- 1.6CDTi 16v (90/105PS)/2.0CDTi 16v: 100A
- Models with air conditioning: 120A

### Maintenance-free battery:

- 1.4i 16v/1.3CDTi 16v: 63Ah
- 1.6CDTi 16v (90/105PS)/2.0CDTi 16v: 72Ah

## Brakes

- Anti-lock Braking System (ABS) with electronic brakeforce distribution

### Front ventilated disc brakes:

- 1.3CDTi 16v/1.6CDTi 16v (90/105PS) 2000 models: 284mm diameter
- 1.4i 16v/2.0CDTi 16v and 2300 models: 305mm diameter

### Rear self-adjusting drum brakes:

- 1.3CDTi 16v/1.6CDTi 16v (90/105PS): 228mm diameter
- 1.4i 16v/2.0CDTi 16v: 254mm diameter

## Fuel tank capacity

60 litres (13.2 gallons).

## Body

- Six-year body panel anti-perforation warranty
- Galvanised body panels
- Anti stone-chip mastic coating on sills
- Flush-fitted windscreen and rear door glass (when specified)
- Detachable front towing eye
- Rear towing eye

## Insurance groups

Range from 2E T2 to 4E T2 dependent on model specified.

## L1 H1

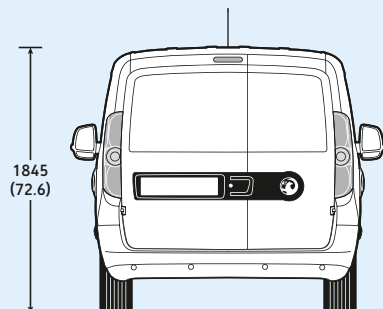
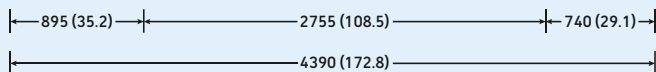
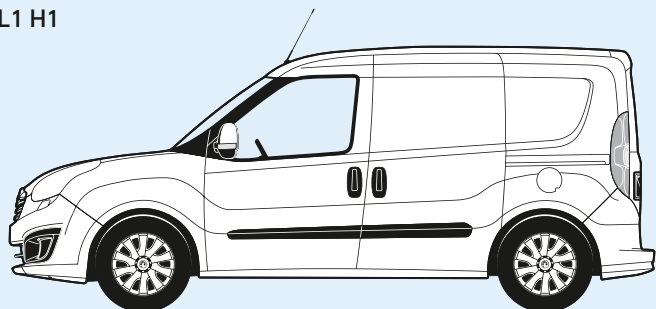

1845  
(72.6)

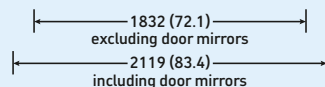

## L1 H2

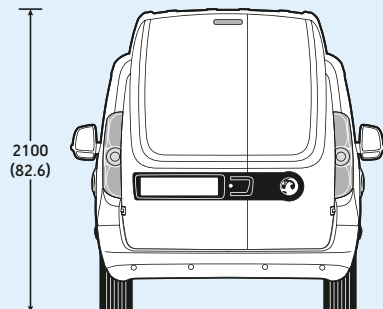
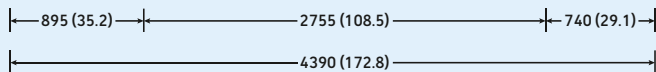
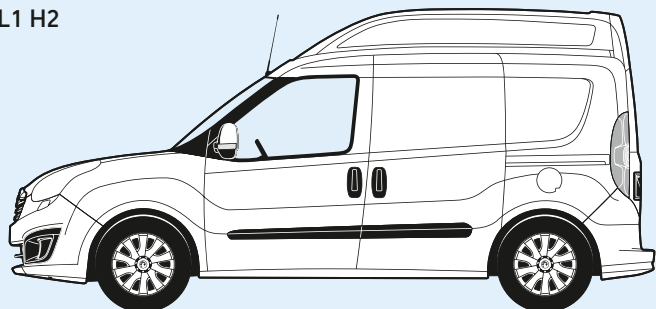

2100  
(82.6)

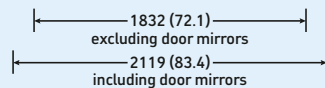

Measurements are shown in millimetres (inches). All heights are shown unladen and exclude roof rails.

## Loadspace dimensions mm (inches)

Maximum load length	L1
Panel van	1820 (71.7)
Crew van with seats up	991 (39.0)
Crew van with seats down	1400 (55.1)

Maximum load width	
At widest point	1714 (67.5)
Between wheel arches	1230 (48.4)

Maximum load height	
Maximum height – H1	1305 (51.4)
Maximum height – H2	1550 (61.0)

Rear and side load door(s)	
Rear door aperture height – H1	1250 (49.2)
Rear door aperture height – H2	1455 (57.2)
Rear door aperture width	1231 (48.5)
Side door aperture height	1175 (46.2)
Side door aperture width	700 (27.5)

Loading height	
Unladen	545 (21.4)

Loadspace volumes cu.m (cu.ft)	L1
H1 panel van	3.4 (121)
H1 crew van with seats up (to top of seats)	0.8 (28.2)
H1 crew van with seats up (to roof)	1.4 (49.4)
H2 panel van	4.0 (141)

## Weights and towing data

	UK Plated weights and kerbweight kg				Payload kg	Towing weights Trailer with brakes (without brakes) kg	Plated Gross Combination Weights (GCW) kg
	Front axle Plated	Rear axle Plated	GVW	Kerb			
<b>L1 H1 Panel van</b>							
2000 1.4i 16v (95PS) S/S	1090	1140	1990	1240	750	1000 (500)	2990
2000 1.3CDTi 16v (90PS) (inc. ecoFLEX S/S)	1090	1140	2020	1270	750	1000 (500)	3020
2000 1.6CDTi 16v (90PS) S/S Tecshift	1090	1140	2060	1310	750	1300 (500)	3360
2000 1.6CDTi 16v (105PS) S/S	1090	1140	2060	1310	750	1300 (500)	3360
2300 1.3CDTi 16v (90PS) (inc. ecoFLEX S/S)	1090	1450	2290	1290	1000	1000 (500)	3290
2300 1.6CDTi 16v (90PS) S/S Tecshift	1090	1450	2330	1330	1000	1300 (500)	3500
2300 1.6CDTi 16v (105PS) S/S	1090	1450	2330	1330	1000	1300 (500)	3500
2000 1.3CDTi 16v (90PS) Sportive (inc. ecoFLEX S/S)	1090	1140	2020	1315	705	1000 (500)	3020
2000 1.6CDTi 16v (105PS) S/S Sportive	1090	1140	2060	1355	705	1300 (500)	3360
2000 2.0CDTi 16v (135PS) Sportive	1120	1140	2100	1395	705	1500 (500)	3500
2300 1.3CDTi 16v (90PS) Sportive (inc. ecoFLEX S/S)	1090	1450	2290	1335	955	1000 (500)	3290
2300 1.6CDTi 16v (105PS) S/S Sportive	1090	1450	2330	1375	955	1300 (500)	3500
2300 2.0CDTi 16v (135PS) Sportive	1120	1450	2370	1415	955	1500 (500)	3500
<b>L1 H2 Panel van</b>							
2000 1.6CDTi 16v (90PS) S/S Tecshift	1090	1140	2080	1330	750	1300 (500)	3380
2000 1.6CDTi 16v (105PS) S/S	1090	1140	2080	1330	750	1300 (500)	3380
2300 1.6CDTi 16v (90PS) S/S Tecshift	1090	1450	2350	1350	1000	1300 (500)	3500
2300 1.6CDTi 16v (105PS) S/S	1090	1450	2350	1350	1000	1300 (500)	3500
2000 1.6CDTi 16v (105PS) S/S Sportive	1090	1140	2080	1370	710	1300 (500)	3380
2300 1.6CDTi 16v (105PS) S/S Sportive	1090	1450	2350	1390	960	1300 (500)	3500
<b>L1 H1 Crew van (unglazed)</b>							
2300 1.3CDTi 16v (90PS) (inc. ecoFLEX S/S)	1090	1310	2190	1415	775	1000 (500)	3190
2300 1.6CDTi 16v (105PS) S/S	1090	1310	2230	1455	775	1300 (500)	3500
<b>L1 H1 Crew van (glazed)</b>							
2300 1.3CDTi 16v (90PS) (inc. ecoFLEX S/S)	1090	1310	2190	1450	740	1000 (500)	3190
2300 1.6CDTi 16v (105PS) S/S	1090	1310	2230	1490	740	1300 (500)	3500
<b>L1 H1 Crew van Sportive</b>							
2300 1.3CDTi 16v (90PS) (inc. ecoFLEX S/S)	1090	1310	2190	1435	755	1000 (500)	3190
2300 1.6CDTi 16v (105PS) S/S	1090	1310	2230	1475	755	1300 (500)	3500

S/S = Start/Stop.

**Note: Kerbweights** for standard vehicles include coolant, oil, 90% full fuel tank and spare wheel. They will vary according to the vehicle specification (including options and accessories) with a corresponding variation in payload. **Payload** figures do not allow for the weight of the driver, or any passengers, which should therefore be deducted from the figures shown. **Gross plated weights** (including axle weights) quoted on the vehicle plate must never be exceeded. **Roof load** on H1 models should not exceed 100kg including the weight of the roof rack/carrier when Vauxhall approved carrier system used. H2 models are not permitted to carry roof loads.

## L2 H1

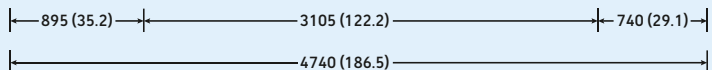
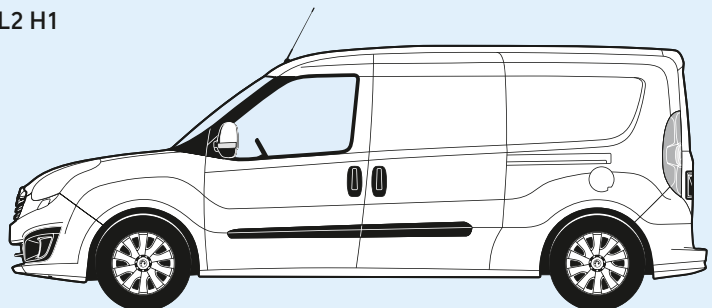

1880  
(74.0)

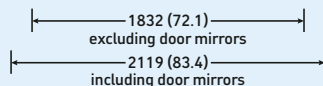
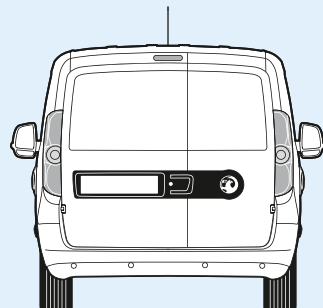

## L2 H2

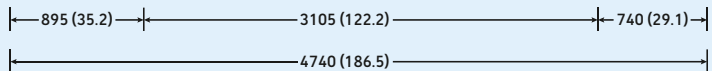
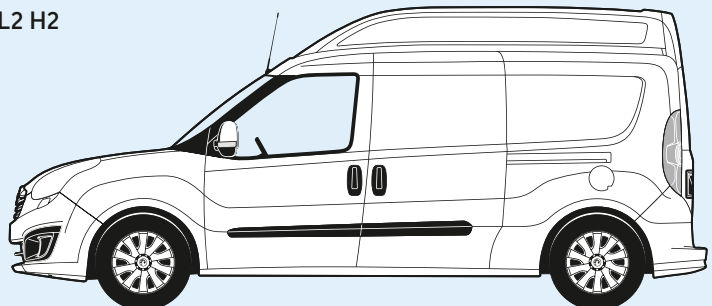

2125  
(83.6)

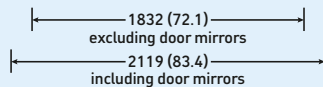
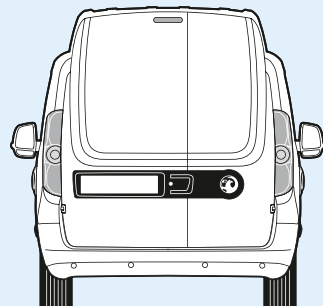

Measurements are shown in millimetres (inches). All heights are shown unladen and exclude roof rails.

## Loadspace dimensions mm (inches)

Maximum load length	L2
Panel van	2170 (85.4)
Crew van with seats up	1341 (52.8)
Crew van with seats down	1750 (68.9)

Maximum load width	
At widest point	1714 (67.5)
Between wheel arches	1230 (48.4)

Maximum load height	
Maximum height – H1	1305 (51.4)
Maximum height – H2	1550 (61.0)

Rear and side load door(s)	
Rear door aperture height – H1	1250 (49.2)
Rear door aperture height – H2	1455 (57.2)
Rear door aperture width	1231 (48.5)
Side door aperture height	1175 (46.2)
Side door aperture width	700 (27.5)

Loading height	
Unladen	545 (21.4)

## Loadspace volumes cu.m (cu.ft)

	L2
H1 panel van	4.2 (148)
H1 crew van with seats up (to top of seats)	1.0 (35.3)
H1 crew van with seats up (to roof)	1.9 (67.1)
H2 panel van	5.0 (177)

## Weights and towing data

	UK Plated weights and kerbweight kg				Payload kg	Towing weights Trailer with brakes (without brakes) kg	Plated Gross Combination Weights (GCW) kg
	Front axle Plated	Rear axle Plated	GVW	Kerb			
<b>L2 H1 Panel van</b>							
2300 1.4i 16v (95PS) S/S	1090	1450	2200	1300	900	1000 (500)	3200
2300 1.3CDTi 16v (90PS) (inc. ecoFLEX S/S)	1090	1450	2330	1330	1000	1000 (500)	3330
2300 1.6CDTi 16v (90PS) S/S Tecshift	1090	1450	2370	1370	1000	1300 (500)	3500
2300 1.6CDTi 16v (105PS) S/S	1090	1450	2370	1370	1000	1300 (500)	3500
2300 1.3CDTi 16v (90PS) Sportive (inc. ecoFLEX S/S)	1090	1450	2330	1360	970	1000 (500)	3330
2300 1.6CDTi 16v (105PS) S/S Sportive	1090	1450	2370	1400	970	1300 (500)	3500
<b>L2 H2 Panel van</b>							
2300 1.6CDTi 16v (105PS) S/S	1200	1450	2460	1460	1000	1300 (500)	3500
2300 1.6CDTi 16v (90PS) S/S Tecshift	1200	1450	2460	1460	1000	1300 (500)	3500
<b>L2 H1 Crew van (unglazed)</b>							
2300 1.3CDTi 16v (90PS) (inc. ecoFLEX S/S)	1090	1310	2230	1465	765	1000 (500)	3230
2300 1.6CDTi 16v (105PS) S/S	1120	1310	2270	1505	765	1300 (500)	3500
<b>L2 H1 Crew van (glazed)</b>							
2300 1.3CDTi 16v (90PS) (inc. ecoFLEX S/S)	1090	1310	2230	1500	730	1000 (500)	3230
2300 1.6CDTi 16v (105PS) S/S	1120	1310	2270	1540	730	1300 (500)	3500
<b>L2 H1 Crew van Sportive</b>							
2300 1.3CDTi 16v (90PS) (inc. ecoFLEX S/S)	1090	1310	2230	1485	745	1000 (500)	3230
2300 1.6CDTi 16v (105PS) S/S	1120	1310	2270	1525	745	1300 (500)	3500

S/S = Start/Stop.

**Note: Kerbweights** for standard vehicles include coolant, oil, 90% full fuel tank and spare wheel. They will vary according to the vehicle specification (including options and accessories) with a corresponding variation in payload. **Payload** figures do not allow for the weight of the driver, or any passengers, which should therefore be deducted from the figures shown. **Gross plated weights** (including axle weights) quoted on the vehicle plate must never be exceeded. **Roof load** on H1 models should not exceed 100kg including the weight of the roof rack/carrier when Vauxhall approved carrier system used. H2 models are not permitted to carry roof loads.

# Trust Vauxhall

## Protecting the environment

Vauxhall's commitment to the environment is demonstrated by our products' many environmental awards, won both through the use of more recycled materials and by becoming cleaner and more efficient. For information on Vauxhall's efforts to achieve an environmentally sustainable future, see [www.vauxhall.co.uk/recycling](http://www.vauxhall.co.uk/recycling)

## Fleet Customer Services

Our dedicated support services for fleet managers include factory demonstrators and information on whole life costs, company car and van taxation and finance. For further information please call **0870 010 0651**.

## Vauxhall Extended Warranty

For complete peace of mind Vauxhall offers an extended warranty that can be purchased on an annual basis following the expiry of the original new vehicle warranty. It covers most mechanical and electrical components. Terms and conditions apply. For further details please contact your local Vauxhall Commercial Vehicle retailer.



When you have finished with this brochure please recycle it

## Business Lease

Business Lease, from GMAC, offers the versatility of a purchase-based finance plan, while making the most efficient use of tax and cash-flow benefits for VAT-registered business users. It's available for all Vauxhall Commercial Vehicles up to 12 months old and offers highly flexible term lengths, variable deposits and a choice of payment profiles. Ask your retailer for full details.

## Business First

Available to business users only, Business First enables you to drive a new vehicle without a large, initial financial outlay. You pay to use the vehicle, not to own it. The vehicle is provided over a predetermined period, and when that period comes to an end the vehicle is returned. Ask your retailer for full details.

## Servicing and maintenance

The best way to maximise the performance and reliability of your Vauxhall is to have all routine servicing and maintenance carried out at a Vauxhall Commercial Vehicle retailer. Nationwide there are over 250 light commercial vehicle retailers and a further 195 heavy commercial vehicle retailers.

## In the event of an accident...

Vauxhall Accident Support helps keep you mobile following an accident. Benefits include scene-of-accident advice, message service, assistance with claims and vehicle recovery. For further details call **0800 010 304**.

## Premier Service Centres

Our Premier Service Centres feature a guaranteed same day repair service (provided the parts are in stock) and an appointment-free service for diagnosis and repairs taking less than 90 minutes. All repairs are carried out within 24 hours of the diagnosis.

## For more information...

For a brochure on any Vauxhall model (up to a maximum of three per caller) or location of your nearest retailer, call **0845 600 1500**.

Alternatively, details can be found on our website at: [www.vauxhall.co.uk/vans](http://www.vauxhall.co.uk/vans)

Proud Sponsor of Home Nations Football



Every effort has been made to ensure that the contents of this publication were accurate and up-to-date at the time of going to press (February 2014). Vauxhall vehicles are equipped with components manufactured by various General Motors operating units and outside suppliers. The Company reserves the right to alter specifications and withdraw products from sale without notice. Any such alterations will be notified to Vauxhall retailers at the earliest opportunity; please consult your local retailer for the latest information. The specifications detailed within this brochure are not necessarily applicable to alternative models such as Special Editions. Details of any such models will be contained in specific literature or found on the Vauxhall website. Please note that Vauxhall retailers are not the agents of General Motors UK Limited and are not authorised to bind the Company by any specific or implied undertaking or representation. It is advisable to ensure that your motor insurance policy provides adequate cover for additional fitted options and accessories. Please note accessories shown are for illustrative purposes only. As part of Vauxhall's policy of environmental care, this brochure is printed on paper manufactured using Elemental Chlorine Free pulps from specially farmed, sustainable timber resources. All rights reserved. No part of this publication may be reproduced in any form or by any means, without the prior written permission of General Motors UK Limited.

VM1310606

©2014 General Motors UK Limited

Published February 2014

General Motors UK Limited, Luton LU1 3YT

**COMMERCIAL VEHICLES**  
*The Wheels of Business*



**VAUXHALL**