

VXR

2018 Models Edition 1



VAUXHALL

VX_VXR_22793



CONTENTS

Live the Change	2	Corsa, GTC Infotainment	24
Corsa VXR	4	Vauxhall OnStar	26
GTC VXR	12	My Vauxhall	29
Corsa, GTC Technical Guide	20	VXR Colours and Trims	30

VXR LIVE THE CHANGE

NEW LIMITS

Advances in automotive technology have diluted the modern driving experience to the point where many of today's 'performance' cars have become soulless and uncommunicative.

You feel like you're not actually driving. You feel like you're being driven: you feel disconnected.

VXR changes all that. VXR is here to reconnect the driver to the road – not with a wire, but with a heartbeat. There's a range of VXR models, every one a focused performance machine, the kind you want to be driving if you like to get up in the night for a blast, just for the hell of it. If you are that type of person, then you've got VXR in your blood. You just might not know it yet.



The Corsa VXR illustrated on the following pages features VXR Performance Pack, VXR Carbon Pack, panoramic glass sunroof, dark-tinted rear windows and Flash Blue two-coat premium paint, optional at extra cost.



CORSA VXR

Every heart needs to feel the blood pump faster once in a while.

With a 1.6 litre turbocharged 205PS unit delivering 280Nm* of torque for a breathtaking 0-60mph clock of just 6.5 seconds, the powerful Corsa VXR is sure to get your blood pumping.

*For 11 seconds with turbo overboost function.





DESIGNED TO PERFORM

Strap yourself into the Recaro sports seat. Settle into the new driver-focussed ergonomics. Now turn the key and the Remus twin exit exhaust system sounds off. You feeling it?

Out on the road Corsa VXR does not disappoint. Aggressive exterior style hints at its true performance potential, while a fully redesigned sports chassis with Koni Frequency Selective Damping (FSD) connects you to the road, balances your ride and comforts your body, even when you're driving hard.

STREET SMART

From its muscular styling to its awesome road agility, the Corsa VXR demands to be driven. So settle into the Recaro sports seat and immerse yourself. Every detail of the new interior design and equipment list exists for one reason. To put you in total control. There's plenty of exclusive VXR hardware to be found too, with IntelliLink audio technology to keep you entertained in more ways than one.

- // Recaro shell-backed cloth sports front seats with Morrocana-trimmed side bolsters and integral head restraints
- // Three-spoke flat-bottomed leather-covered sports steering wheel
- // Unique VXR instrument panel with stepper motor speedometer and tachometer
- // Unique short-throw VXR gear lever
- // Sports pedals
- // VXR alloy-effect door sill covers
- // Heated windscreen
- // Vauxhall OnStar – see page 40 for more information
- // R4.0 IntelliLink infotainment system
- // Smartphone projection
- // Supports Apple CarPlay™
- // Supports Android Auto™
- // Bluetooth® connectivity
- // Digital radio
- // Remote control security alarm system
- // Air conditioning
- // Cruise control and trip computer

1. Recaro seats. Corsa VXR comes with height-adjustable, 'shell-backed' Recaro VXR sports front seats to keep you in place when the going gets a little quick. They provide just the support you need right where you need it. And they look pretty awesome too.

2. VXR facia. This is where it all happens if you're a Corsa VXR driver. Black sports instruments with translucent rings and red highlights. Illuminated translucent switches. Cruise control. Trip computer. A choice from one of three colour co-ordinated facia combinations.* It's all here and at your fingertips. Think of it as VXR mission control.

3. VXR short-throw VXR gear lever. Improved shift fluidity means improved performance through the gears. More information on page 11.

4. VXR detailing. The Corsa VXR interior is packed with VXR-specific details. A leather-trimmed gear knob with VXR-logo takes charge of the six-speed gearbox. There are sports pedals, and VXR-logo floor mats and sill covers.

The new R4.0 IntelliLink infotainment system is standard on Corsa VXR. Designed to work without a CD, the system features digital radio, USB and Bluetooth® with voice control, all easy to use with a seven-inch touchscreen. You can even give Siri voice instructions through your iPhone. And with smartphone projection also included you can even display certain apps from your smartphone using either Apple CarPlay™ or Android Auto™. Upgrade to the Navi 4.0 IntelliLink and you add an integrated sat nav system too.

*Dependant on exterior paint colour. See page 44 for more information. Apple CarPlay is a trademark of Apple Inc. Apple and iPhone are trademarks of Apple inc., registered in the U.S. and other countries. Android is a trademark of Google inc., also registered in the U.S. and other countries.



VX_VXR_23596



VX_VXR_24086

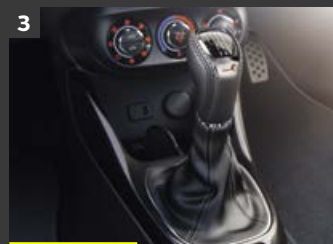

VX_VXR_22797



VX_VXR_23004

POWER UP FOOT DOWN

In every way, this is one powerful and agile Corsa VXR.

The lightweight 1.6 litre turbo engine pumps out 205PS. And with the software-controlled overboost there's 280Nm of torque available from just 1900rpm, meaning this VXR can dispatch 50-75mph in just 6.4 seconds* in fifth gear (where legal) for superbly effortless overtaking.

Exterior features

- // VXR rear roof spoiler
- // VXR sports front grille and air dam/bumper
- // VXR side sills
- // VXR rear bumper incorporating diffuser
- // Dual Remus exhaust system
- // LED daytime running lights
- // Bi-xenon headlights

*With turbo overboost function

VX_VXR_23232



Aero style. The rear tailgate spoiler guarantees maximum visual impact.

VX_VXR_22793



VX_VXR_22793



Design theme. Optional carbon fibre-effect front grille bar and door mirrors complete the racing theme.

VX_VXR_23232



Tuned for sound. Corsa VXR's vocal, Remus twin-exit exhaust system sits within a rear diffuser set up.

Engine, transmission and chassis.

The chassis gets plenty of work too, with Koni Frequency Selective Damping (FSD) as standard, lowered sports suspension, a short-throw gear lever, two-stage switchable Electronic Stability Programme (ESP) and traction control and ABS with straight line stability and cornering brake control. Absolutely everything is focussed on rapid, stable and safe progress.

Engine

- // 1.6i 16v ECOTEC-4 Turbo (1598cc)
- // Maximum power: 205PS (151kW) @ 5800rpm
- // Maximum torque: 280Nm** (181 lb.ft.) @ 1900-5800rpm
- // Compression ratio: 8.8:1
- // Bore/stroke: 79.0mm x 81.5mm
- // Turbocharger integrated into exhaust manifold
- // Intercooler
- // Sodium-filled exhaust valves

**245Nm increased to 280Nm for 11 seconds with turbo overboost function.

Performance

(manufacturer's figures)

- // Maximum speed: 143mph
- // Acceleration 0-60mph: 6.5 seconds
- // Acceleration 50-75mph in fifth gear: 6.4 seconds*

Fuel economy and emissions mpg (litres/100km)

- // Urban driving: 28.5 (9.9)
- // Extra-urban driving: 45.6 (6.2)
- // Combined figure: 37.7 (7.5)
- // CO₂ emissions: 174g/km

Chassis, suspension and brakes

- // Up-rated VXR sports suspension lowered by 10mm with Koni FSD
- // Two-stage switchable ESP including traction control
- // Front ventilated disc brakes: 308mm diameter
- // Rear disc brakes: 264mm diameter

Transmission

- // Six-speed short shift gearbox
- // Gear ratios: 1st – 3.82:1, 2nd – 2.16:1, 3rd – 1.48:1, 4th – 1.07:1, 5th – 0.88:1, 6th – 0.74:1, Final drive – 4.18:1

Insurance group (ABI recommended)

- // 30A

Wheels and tyres

- // 17-inch 5-spoke alloy wheels with 215/45 R 17 ultra-low profile tyres
- // 18-inch 5-Y-spoke bi-colour alloy wheels with 215/40 R 18 ultra-low profile tyres, optional at extra cost
- // Car supplied with emergency tyre inflation kit in lieu of spare wheel

TYRE RATING (ACCORDING TO EU REGULATION 1222/2009)

TYRE SIZE	215/45 R 17	215/40 R 18
Fuel efficiency group	F	F
Wet grip performance	A	A
External noise measured (dB)	71	71
External noise group	(C))	(C))

17-inch 5-spoke

VX_VXR_22795

18-inch 5-Y-spoke bi-colour optional at extra cost.



GTC VXR

When you're left breathless, sweating and with the sound of your own heartbeat pounding in your ears, don't say we didn't warn you.

The GTC VXR certainly means business. Packing an aggressive 280PS, 400Nm 2.0 litre turbocharged direct injection engine, it's just begging to be taken out for a blast. With a custom-built chassis – developed at the renowned Nürburgring – featuring HiPerStrut front suspension with limited-slip differential and a Watts link semi-independent rear suspension there's unparalleled connection with the road.

The GTC VXR illustrated on the following pages features VXR Aero Pack, (VXR bi-plane rear roof spoiler, VXR extended side sills and 20-inch 5-Y-spoke bi-colour alloy wheels) and Flash Blue two-coat premium paint, optional at extra cost.

POWER AND PERFORMANCE

GTC VXR comes fully loaded
and ready to fire.

When you take into account its drop-
dead exterior styling – including meaty
19-inch alloys – there's no mistaking
that this extraordinary VXR won't just
turn heads – it'll blow minds.



WHERE MAN MEETS MACHINE

Take a seat in GTC VXR and kick your senses into overdrive. From the very moment you get behind the wheel, you'll recognise this interior has been designed with real drivers in mind.

Interior features

- // Premium VXR sports front seats with Morrocana side bolsters
- // VXR floor mats
- // Three-spoke flat-bottomed leather-covered sports steering wheel with VXR logo
- // VXR leather-covered gear knob
- // Unique VXR instrument graphics
- // VXR sports pedals
- // VXR alloy-effect door sill covers
- // Vauxhall OnStar - see page 40 for more information

VXR detailing. The unique VXR detailing, premium VXR sports front seats and intuitive driver ergonomics leave no doubt as to why this VXR just demands to be driven.

VXR Performance Seat Pack. For the ultimate driving experience specify this optional Pack featuring powered lumbar and side bolster supports. This is also included when you choose the Leather Pack option (illustrated right). Available with black or blue central stripe.

1. VXR Instruments. Bold instrument graphics and sports pedals set your heart racing before you've even turned the key. We've even included a flat-bottomed leather-covered steering wheel with VXR detail to give you something to cling to when the fun really starts.

2. and 3. VXR Infotainment. The CD 600 IntelliLink audio unit is now standard on GTC VXR. Featuring a 7-inch high-resolution colour display, audio streaming via Bluetooth® – complete with Gracenote® compatibility – and the ability to show individual pictures uploaded via USB are just two of its many features. A DMB digital radio and USB connection are there too to add that favourite soundtrack to your drive. The optional availability of the Navi 650 or Navi 950 IntelliLink sat nav units (illustrated right) mean you can stay in touch wherever your journey takes you, with the 950 unit also featuring voice commands for navigation, phone calls and music track choice.



VX_VXR_22305



VX_VXR_21127



VX_VXR_22304



VX_VXR_23600

3 LETTERS, 1 MESSAGE: VXR PERFORMANCE

Make no mistake about it – the GTC VXR was born to perform. Every inch of its chassis has been geared towards rubber hitting road. Take a drive for yourself:

Exterior features

- // VXR honeycomb sports front grille and air dam/bumper
- // VXR side sills
- // VXR rear bumper with diffuser
- // VXR rear roof spoiler
- // Performance-optimised twin-exit exhaust system tuned for sound
- // LED rear lights
- // 19-inch five-spoke alloy wheels

VXR Aero Pack*.

Take VXR visual impact to the max.

- // VXR bi-plane rear roof spoiler
- // VXR extended side sills.
- // 20-inch five-Y-spoke bi-colour alloy wheels.

VXR button. Hit the VXR button and the GTC VXR tightens the suspension, sharpens the throttle response and makes the steering more direct.

VXR Performance Seat Pack*.

The ultimate in comfort and support.

- // Electrically adjustable sports front seats with manually adjustable seat cushions
- // Electric lumbar and bolster adjustment
- // Electrically heated front seats

*Optional at extra cost.

VX_VXR_25983

VXR bi-plane rear roof spoiler.

VX_VXR_18576

VX_VXR_24008

VXR rear bumper with diffuser.

VXR Button.

VX_VXR_24009

VXR extended side sills.
20-inch five-Y-spoke bi-colour alloy wheels.

Engine, transmission and chassis.

The GTC VXR is not only one of the most powerful cars in its class, it's the fastest production Astra in Vauxhall's history. At its heart is a 2.0 litre turbocharged direct injection engine, producing 280PS of power and an impressive 400Nm of torque – capable of launching it to 60 miles per hour in 5.9 seconds.

Engine

2.0i 16v ECOTEC-4 Turbo (1998cc)

Maximum power:

280PS (206kW) @ 5300rpm

Maximum torque:

400Nm (295 lb.ft.) @ 2400-4800rpm

Compression ratio: 9.3:1

Bore/stroke: 86.0mm x 86.0mm

// Turbocharger integrated into exhaust manifold

// Intercooler

// Sodium-filled exhaust valves

Performance (manufacturer's figures)

// Maximum speed: 155mph

// Acceleration 0-60mph: 5.9secs

Fuel economy and emissions mpg

(litres/100km)

// Urban driving: 27.7 (10.2)

// Extra-urban driving: 43.5 (6.5)

// Combined figure: 36.2 (7.8)

// CO₂ emissions: 184g/km

Chassis, suspension and brakes

// HiPerStrut front suspension system
see page 21

// Lowered and uprated VXR sports suspension see page 21

// Switchable Electronic Stability Programme (ESP) including traction control

// Brembo ventilated/cross drilled, front disc brakes: 355mm diameter
see page 23

// Brembo 4-piston front brake calipers see page 23

// Ventilated rear disc brakes: 315mm diameter

// Drexler Limited Slip Differential (LSD)
see page 23

Transmission

// Six-speed manual gearbox

Insurance group (ABI recommended)

// 35E

Wheels and tyres

// 19-inch five-spoke alloy wheels with 245/40 R 19 ultra-low profile tyres

// 20-inch five-Y-spoke bi-colour alloy wheels with 245/35 R 20 ultra-low profile tyres
(optional at extra cost as part of the VXR Aero Pack)

// Car supplied with emergency tyre inflation kit in lieu of spare wheel

TYRE RATING (ACCORDING TO EU REGULATION 1222/2009)

TYRE SIZE	215/45 R 17	215/40 R 18
Fuel efficiency group	E	E
Wet grip performance	B	B
External noise measured (dB)	72	72
External noise group	(C(1))	(C(1))

VX_VXR_24025



Standard 19-inch five-spoke alloy wheels with 245/40 R 19 ultra-low profile tyres.

VX_VXR_24026



Optional at extra cost as part of the VXR Aero Pack, 20-inch five-Y-spoke bi-colour alloy wheels with 245/35 R 20 ultra-low profile tyres.

TECHNOLOGY EXPLAINED

You don't have to be a race car designer to understand why VXR models are so special. The results speak for themselves. But just in case you're wondering about what lies behind our performance features, we've explained a few of them here in a little more detail.

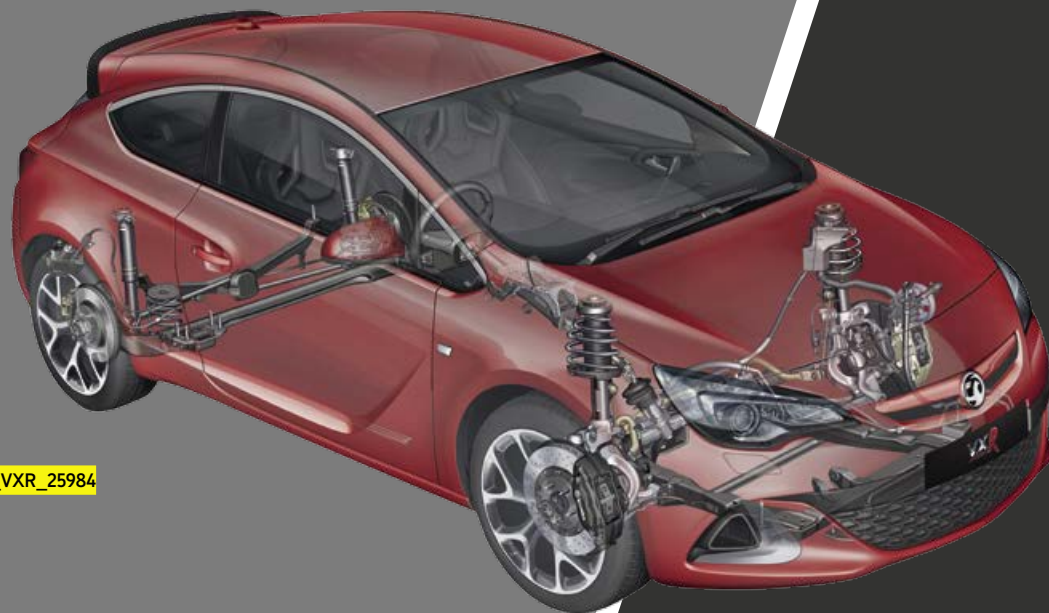

Sports suspension.

It could be argued that creating a sports suspension system is relatively easy; simply fit some uprated springs, dampers and, possibly, anti-roll bars and it's ready. There are plenty of aftermarket kits available, after all. But for VXR we wanted to go a few steps beyond.

VXR models feature all of these, naturally, but we've incorporated a number of extra suspension and steering revisions that separate them from other sports models in the Vauxhall range. Features such as stronger, low-friction anti-roll bar mounts and drop links, which allow the anti-roll bars to work at peak efficiency at all times. Rebound stop springs within the dampers, designed to reduce traction-robbing pitch from the chassis, and revised steering geometry, which gives drivers increased feedback and allows them to more accurately judge grip levels. In addition to the considerable chassis work on the UK's unique road surfaces, much of the development of the VXR range was carried out at the legendary Nürburgring Nordschleife circuit in Germany, the ultimate test of chassis performance. Manuel Reuter, twice winner of the Le Mans 24-hour race, was on the test team and his vast experience contributed to the final set-up of the cars.

VX_VXR_25984

Frequency selective damping.

The Corsa VXR features specially commissioned Koni FSD dampers that adapt almost instantly to changes in road conditions and vehicle behaviour, for ultimate handling without sacrificing ride quality. Order the Performance Pack and the FSD is retuned and enhanced for a greater performance bias with a firmer setting for a serious track day ride.

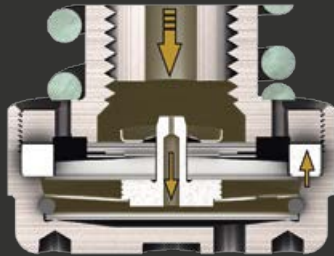

Low frequency

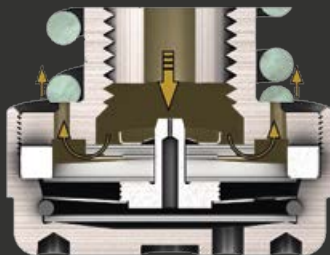

High frequency

HiPerStrut front suspension.

The GTC VXR uses a significant evolution of the regular models' MacPherson strut front suspension. The HiPerStrut (High Performance Strut) front suspension improves grip and allows more power to be applied during cornering. The realigned kingpin axis keeps the front tyres squarer to the road during cornering, providing a better contact patch with the tyre thus delaying the onset of understeer. Additionally the shorter spindle length on the hub significantly reduces torque steer and resists steering kickback on bends and on uneven surfaces. In addition, compared to the standard GTC SRi models, the ride height of the GTC VXR has been reduced by 10mm, spring rates have been stiffened and bespoke suspension bushes are used. To achieve the best handling balance, the front and rear anti-roll bar diameters have also been revised. All of this bespoke VXR engineering detail allows the driver to better exploit the power potential of these powerful VXR models.

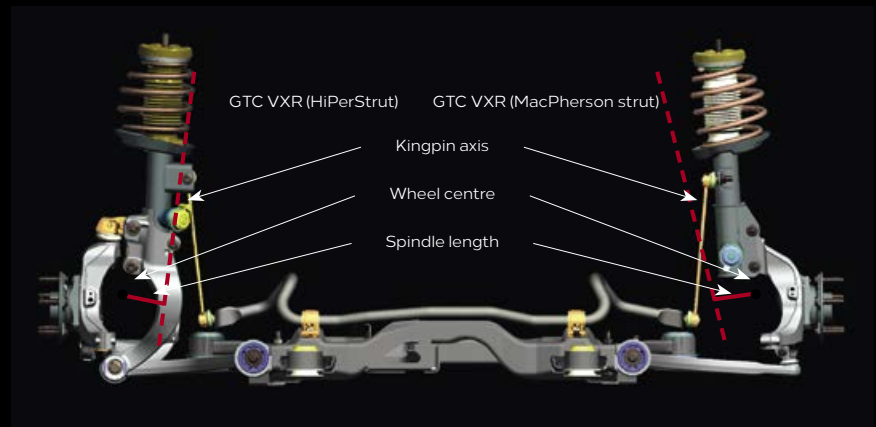

TECHNOLOGY EXPLAINED

1. FlexRide (Adaptive Stability Technology).

The GTC VXR models feature FlexRide – providing three different driving modes: 'VXR' for ultimate driving dynamics (tighter suspension, sharper throttle response and more direct steering) or 'Sport' for everyday sporty driving. 'Normal' is the default mode. The FlexRide adaptive chassis control system with Continuous Damper Control (CDC) monitors the roll, pitch and yaw of the car, and changes the rate of damping on each wheel to optimise the handling and selectively stiffens the suspension. This means the vehicle will exhibit a reduced rate of roll and pitch, making it more responsive during direction changes and more settled during the braking/turn-in/ acceleration transition when cornering. The FlexRide dampers contain magneto rheological (MR) fluid – magnetic particles suspended in a synthetic fluid which change flow rate when a magnetic field is applied. Complex algorithms within the CDC system use acceleration, braking and cornering data to instantaneously adjust the electrical current applied to the electromagnetic coil within each damper – the higher the charge, the greater the damping resistance.

1

VX_VXR_20929

Limited Slip Differential (LSD).

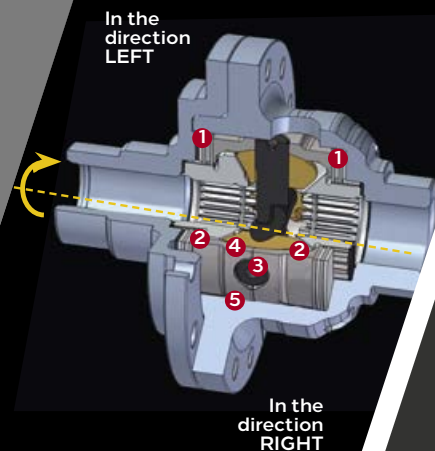

2

2. Limited Slip Differential (LSD).

The Corsa VXR and GTC VXR respectively are the most powerful production Corsa and Astra models ever produced. And to assist putting their power onto the road, both these models have been equipped with a motorsport-derived Drexler Limited Slip Differential. Following extensive development the usual aggressive intervention from a front-wheel drive LSD has been re-tuned to provide outstanding traction and stability without affecting driver enjoyment.

These VXR's Drexler LSD use a series of clutch plates **1** that restricts significant differences in rotational speed between the front wheels limiting wheelspin and enhancing stability. Acceleration and deceleration cause pressure rings **2** next to the clutch plates to push sideways and compress the clutch stack – reducing the speed variation between the two driven wheels. Shaped cams on the differential axis **3** – reacting to differences in torque in the differential vary the amount of compression in the clutch stack – changing the amount of rotational difference between each wheel.

The speed of reaction and the amount of rotational difference are determined by the 'ramp angles' **4** **5** in the pressure rings. The lower the ramp angle, the higher the pressure applied to the clutch stack. On VXR the ramp angles are set-up to provide different characteristics under acceleration and deceleration.



VX_VXR_18650

3. Brembo braking systems.

Corsa VXR (with optional VXR Performance Pack), and GTC VXR both feature a four-piston Brembo front braking system featuring larger diameter ventilated and on GTC VXR cross-drilled front discs. The cast iron discs are mounted on an aluminium centre reducing weight and improving performance. Combined with lighter caliper the new Brembo brakes are up to 30% lighter than the standard system. In each instance the new set-up also utilises high-performance pads which are also 10% larger – giving exceptional stopping power.

3 4. GTC VXR Performance Seat Pack.

The GTC VXR's lightweight performance front seats use composite technology to provide the optimum driver position, lateral location during cornering and ergonomic comfort. The injection moulded shells are formed from a composite of polyamide and fibreglass providing excellent strength and rigidity. Additional benefits include reduced weight (45 percent lighter) and reduced seat depth.

Both driver and front passenger seats are 40mm lower than the Astra Hatchback – helping reduce the VXR's centre of gravity. Despite their overt sporting characteristics the seats can be adjusted up to 18 ways, depending upon specification. Optional pneumatically adjustable side bolsters, provide the optimum lateral location, when ordered as part of the VXR Leather Seat or VXR Performance Seat Pack.



4

Left-hand drive seat illustrated.

INFOTAINMENT

Every VXR is designed to entertain. And that doesn't just mean on the road but in the car too. Digital radio, USB and Bluetooth® connectivity are all there as standard on Corsa VXR and GTC VXR models.

Satellite navigation. Available for Corsa and GTC VXR models. Find your way to anywhere, at any time. Satellite navigation can determine your location and guide you to your destination by the best and fastest route. The Traffic Message Channel function on the GTC VXR can even change the route according to breaking traffic news.

Bluetooth® connectivity. Enables your mobile phone to interface with the infotainment unit for operation via the steering wheel control, facia display or voice activation.

Digital radio. Superb digital quality sound, a broader range of stations easier to find by name and improved track display info on some stations.

1. The new R4.0 IntelliLink infotainment system is standard on Corsa VXR.

Designed to work without a CD, the system features digital radio, USB and Bluetooth® with voice control, all easy to use with a seven-inch touchscreen. You can even give Siri voice instructions through your iPhone. And with smartphone projection also included you can even display certain apps from your smartphone using either Apple CarPlay™ or Android Auto™. Upgrade to the Navi 4.0 IntelliLink and you add an integrated sat nav system too.

2. Phone projection.

Smartphone or tablet, Android or Apple iOS, on Corsa VXR models the IntelliLink infotainment system connects with your facia touchscreen and audio system to access apps and give you music, phone and sat nav on the go.

3. GTC VXR can be specified with an optional premium sound system.

Includes amplifier and speaker upgrades together with digital sound processing for superb all-round sound reproduction under all driving conditions.

Apple CarPlay is a trademark of Apple Inc.
Apple and iPhone are trademarks of Apple inc, registered in the U.S. and other countries.
Android is a trademark of Google inc., also registered in the U.S. and other countries.

1



VX_VXR_24086

2



VX_VXR_24093

3



VX_N_AST_14274

THIS COULD BE THE IDEAL TRAVEL COMPANION

Journeys go faster with great company. It's just a good feeling to have someone with you along the way. Which is why your Corsa VXR and GTC VXR models* come with Vauxhall OnStar¹, a personal connectivity and service assistant who's always there for you, 24/7, 365 days a year.

At the push of a button, it puts you in touch with someone to help you – could be help to find or unlock your car or immediate help in an emergency – whatever happens, it's there.

Oh yes, and how could we forget it also has a super-handy 4G Wi-Fi Hotspot². Perfect for hooking up to seven devices (I want to be at that party).

Isn't this just the kind of mate you'd like on your next road trip?
And we guarantee it won't complain about the music you play.

*Standard on Corsa VXR and GTC VXR models.

1 Vauxhall are not responsible for the provision of OnStar services or Wi-Fi services. OnStar Services require activation and account with OnStar Europe Ltd, (a GM Company). Wi-Fi services require additional account with OnStar Europe Limited's mobile network operator supplier. All services subject to mobile network coverage and availability. Use of OnStar services (except Wi-Fi) is free of charge for 12 months from registration date or delivery of vehicle, whichever comes first. Wi-Fi trial has a time limit and capped data allowance. Charges apply after expiry of applicable trial periods. Check vauxhall.co.uk/onstar for service limitations and charges. **2** The 4G Wi-Fi Hotspot services require account with OnStar Europe Ltd, and nominated network operator. The Wi-Fi trial has a time limit and capped data allowance. Charges apply thereafter. All services subject to mobile network coverage and availability.





SOS

YOU'RE SAFE

With OnStar you have emergency assistance at your fingertips, available 24 hours a day, 365 days a year.

// Automatic Crash Response¹:

in case of a crash and an airbag deploys, our advisors automatically connect to your car. If needed, they immediately brief the emergency services with key car information and can send them to your exact location.

// 24-Hour Emergency Call Service¹:

you or a passenger are not feeling well? Push the red SOS button and our advisors make sure to send help right away.

// Roadside Assistance^{1,3}:

if you have a flat tyre or a warning light in the dashboard goes on, just contact our advisors and they will send Roadside Assistance to your location, if required. This is even more valuable in areas with weaker mobile phone coverage or if your smartphone has run out of battery.

// Stolen Vehicle Assistance¹:

in case your car gets stolen, report it to the police and get a crime reference number. Once the car stops and is turned off, OnStar blocks the ignition so the car can't be restarted again and provides the police with the exact vehicle location to help retrieve your car safely.



YOU'RE WELL CONNECTED

Nowadays, we're pretty used to having Wi-Fi on tap almost everywhere. So why not your car? And you can use the smartphone app to view the status of some functions, locate your car, and lock or unlock it if needs be.

// Wi-Fi Hotspot^{1,2}:

a fast and stable Internet connection enables you and your passengers to work, surf or just stream movies on up to 7 devices – thanks to the powerful OnStar roof antenna.

// Remote Control^{1,4}:

if you forgot to lock your car, you can use your smartphone to remotely lock or unlock it, even from afar, thanks to the **My Vauxhall Smartphone App**.

// Car Locator^{1,4}:

forgot where you've parked? Pinpoint your car's location on the app. If you are close and still do not see it, just blink the headlights or honk the horn to see where you've parked.



YOU'RE LOOKED AFTER

Who wouldn't want a personal assistant? At the touch of a button, you'll be connected to an assistant who's at your service – 24 hours a day, 7 days a week.

// Hotel Booking^{1,5}:

plans changed? Or too tired to keep driving? Let our advisors take care of your hotel booking en route, powered by Booking.com. Just press the blue Service Button.

// Destination Download^{1,6}:

no more address typing! Our advisors assist you in finding an alternative route, a restaurant or a petrol station. They will remotely download the address onto your in-built navigation system, too.

// Parking Service^{1,7}:

never search for a car park space again! Using Parkopedia.com, OnStar can find the nearest car park to your destination. That way, before you even get there, you'll already know the availability and parking fee. With destination download⁶, OnStar can send the information direct to your sat nav, making it even easier. How's that for personal service? All without leaving your new VXR models.

³ OnStar will direct a professional breakdown recovery team to your location. If your car is within the Vauxhall New Vehicle Roadside Assistance coverage period, OnStar will connect with the Vauxhall Roadside Assistance service, who will send help free of charge, subject to the Vauxhall Roadside Assistance terms and conditions. If your vehicle is outside the coverage of the Vauxhall New Vehicle Roadside Assistance service, the provider of the breakdown recovery service may apply charges for the services provided. ⁴ Some elements of Smartphone App may not be available for all cars/trim levels. Check vauxhall.co.uk/onstar for service limitations and charges. ⁵ An OnStar advisor can help you book a hotel room using Booking.com, subject to Booking.com user terms and privacy statement, which can be found on the Booking.com website, and the applicable terms and conditions for your hotel. OnStar assists you in making a booking and is not responsible for the services provided by Booking.com or your hotel. Email address and credit card required. ⁶ Some elements of Smartphone App and Destination Download may not be available for all cars/trim levels. An embedded Vauxhall navigation unit and map data are requirements for the Destination Download service. Check vauxhall.co.uk/onstar for service limitations and charges. ⁷ Only available for car parks which are listed in Parkopedia. Information about availability applies for the time of contact with OnStar.

HOW TO GET ONSTAR

Vauxhall OnStar is standard on Corsa VXR and GTC VXR models.

1. We will send you an e-mail so you can activate your account – then just complete your registration and set your preferences.
2. Just activate OnStar when you take delivery of your new VXR.
3. OnStar is ready to go!

Best of all the OnStar services are free of charge for the first 12 months!
You'll also get a free data trial period for the 4G Wi-Fi Hotspot².

You can purchase Wi-Fi Hotspot data packages separately from the nominated network provider by following the instructions on vauxhall.co.uk/onstar. Charges apply after the free trial period.



To ensure your privacy, you can turn OnStar off and on anytime*.
Find out more at vauxhall.co.uk/onstar

*OnStar can only override the Privacy Button in an emergency or if your car is reported stolen.

1 The OnStar services require activation and account with OnStar Europe Ltd. Charges apply after applicable trial period. All services subject to mobile network coverage and availability. The OnStar subscription packages could be different from the services included in the free trial package. Check vauxhall.co.uk/onstar for details of availability, coverage and charges. Terms and conditions apply.

2 The 4G Wi-Fi Hotspot services require account with OnStar Europe Ltd. and nominated network operator. The Wi-Fi trial has a time limit and capped data allowance. Charges apply thereafter. All services subject to mobile network coverage and availability.

VX_CRO_26708



GET MORE FROM YOUR CAR WITH MY VAUXHALL

My Vauxhall is your one-stop shop for everything to do with your VXR. Manage your OnStar account. Organise your car's next service. Get rewards and exclusive savings for you.

- // **Manage your Vauxhall** – take care of your Vauxhall online and book a service
- // **Access your OnStar services** – get diagnostics reports, manage your subscription and more
- // **Exclusive offers** – stay up to date on special offers, the latest news and current events
- // **Retailer locator** – find your nearest Vauxhall retailer

HOW TO GET MY VAUXHALL

If you already use Vauxhall OnStar, you can access all the My Vauxhall services. Otherwise, simply register for My Vauxhall this way:

1. When you order your VXR, your dealer will help you pre-register for My Vauxhall.
2. We'll send you an e-mail invitation to activate your My Vauxhall account and complete your registration.
3. My Vauxhall is ready to go – use it through any web browser, or the My Vauxhall app on your mobile device, available to download from the Google Play or Apple App Store.



VX_MYVX_27574

COLOURS AND OPTIONAL TRIMS

VXR models are available in a range of great exterior colours*, with complementary interior trim materials – fabric or leather – specially selected to reflect the range’s performance heritage.

*Please refer to the latest VXR Price Guide available from vauxhall.co.uk for details of colour availability by model and price.

Due to the limitations of the printing process the colours reproduced may vary slightly from the actual paint colour and trim material. As a result they should be used as a guide only.

CORSA VXR



Summit White
Brilliant



Lava Red
Brilliant



Mineral Black
Two-coat metallic



Satin Steel Grey
Two-coat metallic



Flash Blue
Two-coat premium



Lime Green
Two-coat premium

GTC VXR



Summit White
Brilliant



Lava Red
Brilliant



Mineral Black
Two-coat metallic



Flash Blue
Two-coat premium

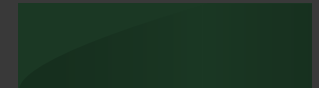

Emerald Green
Two-coat premium

CORSA VXR FACIA TRIM



VX_COR_25895

Piano Black fascia panel with chrome-effect insert. Standard on Mineral Black, Satin Steel Grey, Flash Blue and Lime Green exterior colours.



VX_COR_22202

Piano Black fascia panel with red insert. Standard on Lava Red exterior colour.



VX_COR_22201

Piano Black fascia panel with white insert. Standard on Summit White exterior colour.

CORSA VXR



VX_VXR_22767

Standard: Jet Black Track cloth with Morrocana-trimmed seat bolsters (illustrated on page 9).

Optional at extra cost: VXR Leather Pack (illustrated to the left) comprising leather seat facings and electrically heated Recaro shell-backed sports front seats.

GTC VXR



VX_VXR_23599

Standard: Jet Black Track cloth seat inserts with Cool Pearl stitching on Morrocana-trimmed seat bolsters (illustrated to the left).

Optional at extra cost: Jet Black Nappa soft leather seat inserts with Jet Black stripe and Cool Pearl stitching on seat bolsters.

Jet Black Nappa soft leather seat inserts with Blue stripe and Blue stitching on seat bolsters (illustrated on page 17).

Need more VXR?

Then check us out online. To really immerse yourself in the VXR experience log-on and prepare to be blown away at: vxr.co.uk







Scan this QR code with your smartphone for more information. Don't forget to download a QR reader from your app store first.



*The free 3 Day Test Drive programme is open to Company Car Drivers and Fleet Decision Makers. Available for UK Mainland only. Terms and Conditions apply. Full terms and conditions can be found at vauxhallfleet.co.uk/testdrive/index/terms.
 **Telephone lines open Monday-Friday 9.00am to 5.00pm excluding Bank Holidays. Calls may be recorded or monitored for quality and/or training purposes.

Privacy Policy – For full details please visit: vauxhall.co.uk/privacy
 Vauxhall OnStar privacy details are available at vauxhall.co.uk/onstar

Some feature descriptions in this brochure may refer to, and some illustrations may show, optional equipment not included in the standard delivery. The information contained in this brochure was accurate at the time of going to print. We reserve the right to make changes in design and equipment. The colours printed in the brochure only approximate actual colours. Illustrated optional equipment is available at extra charge. Availability, technical features and equipment provided on our vehicles can vary by model. For precise information on the equipment provided on our vehicles, please contact your local Vauxhall Retailer. As part of Vauxhall's policy of environmental care, this brochure is printed on paper manufactured using Elemental Chlorine Free pulps from specially farmed, sustainable timber resources.

