

Zafira

2011 Models Edition 3



Proud Sponsor of Home Nations Football







make the world adjust to you

Zafira shows what can be achieved with clever thinking. All that dynamic driving experience, interior comfort and built-in seven-seater flexibility – but with sharp styling, cool interior finishes and impressive safety features.

This brochure covers Expression, Life, Exclusiv, Design, Elite, SRi and SRi with Exterior Pack models only. Some of the vehicles shown in this brochure include options and accessories available at extra cost. And not all of the features described are available on every model. So please check the Equipment section for further details. From time to time, we also offer alternative Zafira models such as Special Editions, featured in their own separate literature or found on the Vauxhall website www.vauxhall.co.uk

Exterior styling 4

Driveability 6

Interior comfort 8

Flex7® seating 10

Panoramic roof 12

Environmental issues 14

Driving dynamics 16

Safety and security 18

Interior features 20

Model line-up 22

Options and accessories 28

Colours and trims 32

Equipment 34

Technical data 42



Please see back cover for more details.

always cruise in style

Fed up with boxy looking MPVs? Here's a welcome change. A seven-seater compact people carrier that's definitely got the X-factor. With its radical, tapered roofline, dynamic front grille and bumper shapes, chrome headlight surrounds and great alloy wheel designs too, family travel has never been so attractive.









something for everyone

Yet another dilemma solved. Brilliant family transport and great to drive too – whether you're just one or seven-up. The dynamic Zafira chassis combines precise, secure roadholding with built-in technological innovation. And Vauxhall's advanced engine technology means efficient, multi-valve engines – as flexible and responsive as they are economical and environmentally aware.



real comfort wherever you sit

Zafira's design themes move effortlessly from outside to inside with a driver-friendly fascia and high quality interior finishes throughout. And while it's easy for the driver to get comfortable, this is a car designed to make travel easy for the whole family. So it's light and spacious, comfortable and clever – wherever you're sitting.







space for a quality lifestyle

This is what versatility looks like. And it's all down to clever design – Flex7[®] seating, adaptable luggage space and plenty of smart storage ideas for all your essential travelling kit.







a different look at life

Talk about personalised travel arrangements! The optional Zafira panoramic roof gives you four tinted glass roof panels – with separate, electrically-operated sunblinds – and a five-compartment, central overhead console. So there's always somewhere to put your mobile phone, personal music player, sunglasses or hand held games console.





respect your world

We all share a responsibility to look after our world. That's why Vauxhall has been at the forefront of green automotive initiatives for many years. Most recently, we have been researching ways of developing new cars that are more efficient than ever before. The forthcoming Vauxhall Ampera* is an Extended-Range Electric Vehicle (E-REV) that can drive up to 50 miles on battery power alone and over 300 miles utilising an on-board electric generator system. And of course, we are always looking to reduce vehicle CO₂ emissions and the Zafira 1.7CDTi 16v ecoFLEX models have among the lowest CO₂ emissions of any seven-seat MPV.

But our commitment to your continuing peace of mind goes even further. We have dramatically reduced manufacturing emissions, and our new models use more recycled materials and more recyclable parts than ever before.

We also offer free and easily accessible, environmentally friendly, end-of-life vehicle disposal through our partners Autogreen Ltd.

That way, we reduce our environmental impact in every phase of every vehicle's life cycle. Because your world is our world, too.



*For more information on Vauxhall Ampera please visit www.vauxhall-ampera.co.uk

ecoFLEX

Zafira's lowest emission ecoFLEX engines clearly demonstrate that environmental awareness can be achieved without compromising performance and driveability. Improved fuel economy speaks for itself but lower CO₂ emissions also save you money on Vehicle Excise Duty (VED) and company car taxation. See the table to the right for more details.



 **Six-speed.** Zafira comes with a six-speed manual gearbox as standard on all 1.7CDTi 16v engines. Others come with a five-speed manual as standard.

Petrol engines. Zafira's twin-cam 1.6i 16v VVT and 140PS 1.8i 16v VVT Euro 5 engines feature multi-point sequential fuel injection and utilise Double Continuous Variable Cam Phasing (DCVCP), which provides most of the available torque across a wide rev band. The result? More power, lower fuel consumption and improved CO₂ emissions.

ecoFLEX diesels. Zafira's two turbo diesel ecoFLEX models – a 1.7CDTi 16v (110PS) and 1.7CDTi 16v (125PS) have CO₂ emission figures of only 134g/km. Not only do they save you money with lower Vehicle Excise Duty (VED) charges and benefit in kind company car tax (see table opposite), but they do so without compromising the excellent driveability and performance Zafira is renowned for.

Easytronic transmission. Choose the optional Easytronic transmission – available on the 1.8i 16v VVT petrol versions – and you'll get a five-speed manual gearbox with a fully automatic mode. In manual mode, you simply push the lever forward or back to shift gears up or down. The fascia display tells you what gear you're in – 1 to 5, N for Neutral or A for Auto. Switch to fully automatic mode and it has many of the features of a regular automatic including a kickdown function. There's no clutch pedal so you can drive it on an automatic-only driving licence.

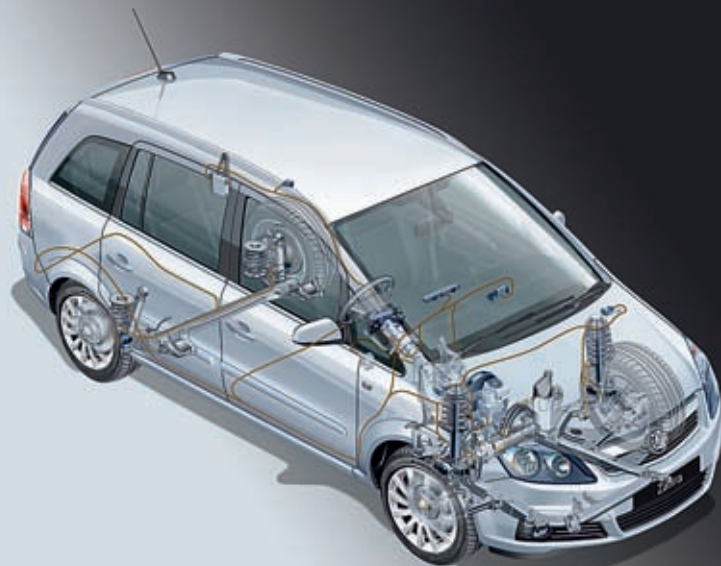

ESP-plus. Especially useful on wet roundabouts and greasy roads or whenever a slippery surface catches you out, Electronic Stability Programme-plus (ESP-plus), senses if the car starts to slide on a bend and applies corrective braking to the appropriate wheels to help you regain control. For further information please see page 47.

Interactive Driving System-plus (IDS-plus). This optional system senses changes in the vehicle dynamics and automatically adjusts the damper rates – in real time. The result is confident cornering and sharper handling with reduced body roll. Pretty smart for a seven-seater compact MPV. For further information please see page 47.

	Combined fuel economy mpg (litres/100km)	CO ₂ emissions (g/km)	VED (2011/12)*		Benefit in kind tax band** (2011/12 tax year)
			First year	Standard	
Petrol					
1.6i 16v VVT	42.2 (6.7)	157	£165	£165	21%
1.8i 16v VVT	39.2 (7.2)	168	£265	£190	23%
1.8i 16v VVT Easytronic	40.4 (7.0)	164	£165	£165	22%
Diesel					
1.7CDTi 16v (110PS) ecoFLEX	55.4 (5.1)	134	£115	£115	19%
1.7CDTi 16v (125PS) ecoFLEX	55.4 (5.1)	134	£115	£115	19%



Sport switch. Sports performance to suit your mood. Hit the Sport switch and you get a sharper throttle and more responsive steering. With optional IDS-plus you also get sportier chassis dynamics with more body control.

*Correct at time of publication (April 2011). **Taxation information for guidance only. Please take professional advice on your own tax position.

Intelligent, reassuring safety and security

Zafira has a strong reputation for safety and security, and with good reason. Every model has a five star EuroNCAP adult occupant safety rating, with six full-size airbags and a chassis that is packed with active safety innovations that help you avoid accidents before they happen. Security features include remote control central deadlocking.



Adaptive Forward Lighting (AFL).

The optional lighting system swivels the headlight beams up to 15 degrees for improved vision as you turn a corner. Above 65mph, it raises the dipped headlight beam slightly, also to increase safety – returning to normal beam automatically as speed is reduced. Turn to page 47 for more detailed information.

ISOFIX Child seat restraint system.

The rigid ISOFIX anchoring mechanism virtually eliminates the dangers of incorrect child seat installation. You simply click the optional accessory Vauxhall ISOFIX child seat into the mounting points engineered into the Zafira outer rear second-row seats.



www.euroncap.com



Anti-lock Braking System (ABS).

On its own, ABS is a huge benefit in emergency braking, but Zafira goes even further. Emergency Brake Assist (EBA), Electronic Brakeforce Distribution (EBD) and Cornering Brake Control (CBC) all make the car easier to control and stop under extreme cornering and braking.

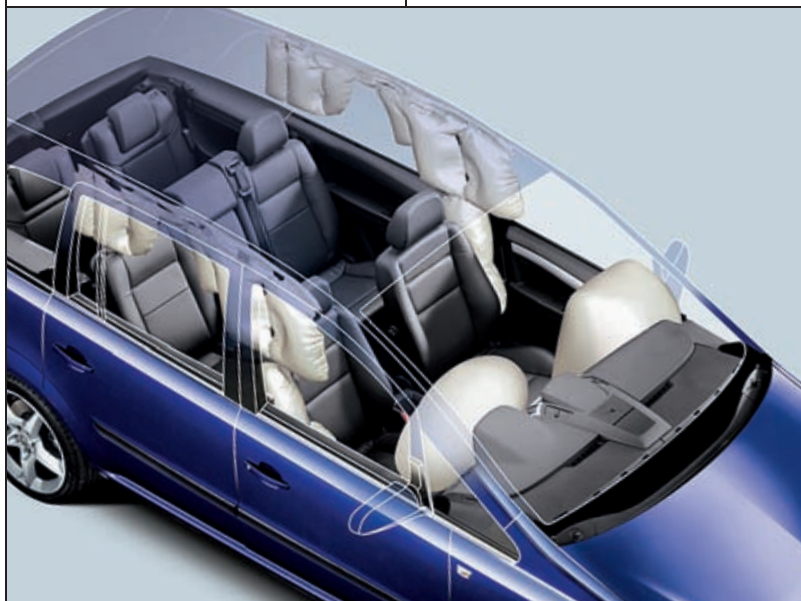

Remote control alarm system.

Standard on SRi, the ultrasonic security alarm system features forced entry detection, along with tilt, movement and rear glass breakage sensors.

Six airbags. Zafira protects you and your family with six full-size airbags as standard on every model. Specially developed to provide maximum protection, every model has twin front airbags, enlarged 'thorax-pelvis' front seat side-impact airbags and full-size curtain airbags too.



Keeping everybody happy

Zafira's Flex7[®] seating. It's not just about quantity. It's about quality too, making everyone feel comfortable – front and rear. Wherever you're sitting, you'll be amazed at what Zafira has to offer, whether it's features like air conditioning and rear seat audio or clever storage space for all your bits and bobs.



◀ ▶ ▼ **Versatile load space.**

When you're not using Zafira's third row seats, there's no need to remove them completely. Each one folds down separately, flush with the load floor. Add the optional FlexOrganiser[®] pack, and you've got the smartest, most versatile way to manage your load area ever!



Quality sounds. Every Zafira features a quality CD player/stereo radio, with steering wheel mounted audio controls on many models. Optional systems add CD/MP3 format, user-friendly satellite navigation with colour display, and our independent rear seat Twin Audio® system* (shown below) where the front and two second-row rear passengers can listen to the radio or a CD independently and at the same time. It comes with separate second-row rear seat audio controls – an on/off switch, independent volume controls for each headset (available as an accessory), switching between CD and radio tuner and a scan function. And it even mutes the rear speakers when the headphones are in use.



Air conditioning. It makes for a fresher interior atmosphere all year round, with chilled air on hot days and faster demisting when it's damp. Move up to Electronic Climate Control (ECC), standard on Elite and optional on many other models and you can maintain the interior temperature to within a single degree.

Cruise control. The easy-to-use, tap-up/tap-down cruise control is standard on Elite and optional on most other models. It allows you to maintain a steady speed without keeping your foot on the throttle. So it's more comfortable on long journeys and easier to keep to speed limits too.



Satellite navigation. You'll never get lost with optional satellite navigation. It can determine your precise location and guide you to your destination by the best and fastest route. Turn to page 41 for more detailed information.



Mobile phone system with Bluetooth®.** With the optional mobile phone system, your phone interfaces with the audio unit, for operation via the steering wheel controls and facia display. Bluetooth® wireless technology with voice activation is included. See page 41 for more detailed information.

Multi-function trip computer. Standard on Zafira Design, Elite and SRI this invaluable driver information system provides instantaneous and average fuel consumption, fuel consumed, average speed, distance travelled and range based on fuel remaining.

*Does not include headsets. Fitted with industry standard 3.5mm audio sockets.



**Please refer to the online Vauxhall Car and Accessory Price Guide for a list of phone-specific cradles.

EXPRESSION AND LIFE

Standard features include:

- Anti-lock braking system
- Power-assisted steering
- Twin front airbags
- Electronic Stability Programme-plus (ESP-plus) with traction control
- Front seat side-impact airbags
- Full-size curtain airbags
- Driver's seat height adjuster
- Electric door mirrors
- Electric front windows
- Remote control central deadlocking
- Steering wheel adjustable for reach and rake
- Air conditioning (Life models only*)
- CD player/stereo radio (CD 30)
- 12-volt auxiliary power socket located in luggage compartment
- Black roof rails (Life models only)



Engine availability	Insurance groups (ABI)
Expression	
1.6i 16v VVT	12E
Life	
1.6i 16v VVT	13E
1.8i 16v VVT	15E
1.8i 16v VVT Easytronic	15E
1.7CDTi 16v (110PS) ecoFLEX	14E
1.7CDTi 16v (125PS) ecoFLEX	17E

*Non-air conditioned 1.6i 16v model also available

Life model interior illustrated.

Please note: Insurance groups relate to the 50 group rating.



EXCLUSIV

Standard features include:

- Anti-lock braking system
- Twin front airbags
- Front seat side-impact airbags
- Full-size curtain airbags
- Driver's seat height adjuster
- Electric front windows
- Remote control central deadlocking
- Steering wheel adjustable for reach and rake
- Air conditioning
- CD player/stereo radio (CD 30)

Additional features over and above Life model include:

- 16-inch Structure wheels
- Leather-covered three-spoke steering wheel
- Steering wheel mounted audio controls
- Piano black-effect centre console
- Electrically adjustable/heated door mirrors
- Dark-tinted rear glass
- Body-colour door handles and side-protection mouldings

Engine availability	Insurance groups (ABI)
1.6i 16v VVT	12E
1.8i 16v VVT	15E
1.8i 16v VVT Easytronic	15E
1.7CDTi 16v (110PS) ecoFLEX	14E
1.7CDTi 16v (125PS) ecoFLEX	17E

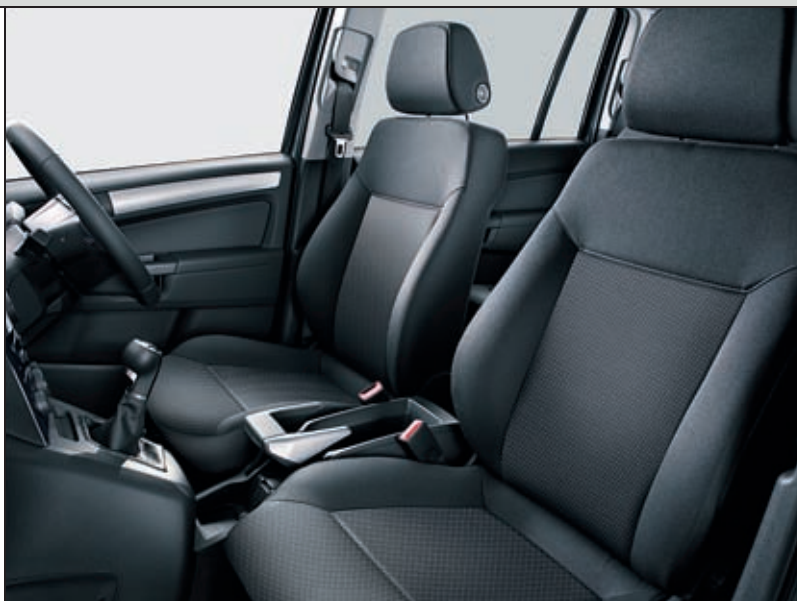

Please note: Insurance groups relate to the 50 group rating.

Model illustrated features two-coat metallic paint, optional at extra cost.

DESIGN

Standard features include:

- Anti-lock braking system
- Twin front airbags
- Front seat side-impact airbags
- Full-size curtain airbags
- Electric front windows
- Dark-tinted rear glass
- Remote control central deadlocking
- Leather-covered three-spoke steering wheel
- Steering wheel adjustable for reach and rake
- Air conditioning
- CD player/stereo radio (CD 30)

Additional features over and above Exclusiv model include:

- 16-inch seven twin-spoke alloy wheels
- Front fog lights
- Multi-function trip computer
- Electric rear windows
- Driver's armrest
- Driver's seat with tilt and lumbar adjustment
- Rain-sensitive windscreen wipers
- Alloy-effect roof rails



Engine availability	Insurance groups (ABI)
1.6i 16v VVT	15E
1.8i 16v VVT	15E
1.8i 16v VVT Easytronic	15E
1.7CDTi 16v (110PS) ecoFLEX	14E
1.7CDTi 16v (125PS) ecoFLEX	17E

Model illustrated features Panoramic Roof Pack and two-coat metallic paint, optional at extra cost

Please note: Insurance groups relate to the 50 group rating.



ELITE

Standard features include:

- Anti-lock braking system
- 16-inch seven twin-spoke alloy wheels
- Six airbags
- Electric front and rear windows
- Dark-tinted rear glass
- Multi-function trip computer
- Driver's armrest
- Leather-covered three-spoke steering wheel
- Rain-sensitive windscreen wipers
- Alloy-effect roof rails

Additional features over and above Design model include:

- Leather seat facings on front and second row seats (third row seats trimmed in Morrocana)
- Electrically heated sports front seats with tilt and lumbar adjustment
- Electronic climate control
- Cruise control
- CD player with MP3 format/auxiliary-in socket/stereo radio (CD 30 MP3)

Engine availability	Insurance groups (ABI)
1.8i 16v VVT	16E
1.7CDTi 16v (110PS) ecoFLEX	15E
1.7CDTi 16v (125PS) ecoFLEX	18E



Please note: Insurance groups relate to the 50 group rating.

Model illustrated features two-coat metallic paint, optional at extra cost.



SRI and SRi with Exterior Pack

SRI

Standard features include:

- Anti-lock braking system
- Six airbags
- Air conditioning
- Electric front windows
- Dark-tinted rear glass
- Leather-covered three-spoke sports steering wheel

Additional features over and above Exclusiv model include:

- 17-inch five-spoke alloy wheels
- Remote control ultrasonic security alarm
- Sports suspension
- Sport switch
- Electric rear windows
- Matt chrome-effect centre console
- Front fog lights
- Multi-function trip computer
- Sports front seats with driver's armrest
- Driver's seat with tilt and lumbar adjustment
- Rear roof spoiler
- Sunglasses holder
- Alloy-effect roof rails

Additional features for SRI models with Exterior Pack (illustrated left):

- 18-inch five-spoke alloy wheels
- VXR Styling Pack

Zafira SRI model illustrated left features two-coat pearlescent paint, optional at extra cost.



Model illustrated left features two-coat pearlescent paint, optional at extra cost.

 **Satellite navigation system/CD player with MP3 format/auxiliary-in socket/stereo radio/colour graphic information display (CD 70)*.**

**Optional at extra cost.*



Engine availability	Insurance groups (ABI)
1.8i 16v VVT	16E
1.7CDTi 16v (125PS) ecoFLEX	18E

Please note: Insurance groups relate to the 50 group rating.

Vauxhall options and accessories are all about choice – selecting your new car, then personalising it to suit yourself. There's a choice of factory-fitted options and a huge range of retailer-fit accessories. You can also choose styling products from the VXR range as well as auto design specialist Irmischer International. Available individually or in special packs at great prices. You'll find further information on the following pages or just ask your Vauxhall retailer for more details.



VXR Styling

Inspired by our racing heritage, VXR styling products come with all the same experience, knowledge and passion for style and performance. They put the accent firmly on quality and exclusivity, with a winning edge. And they add flair, personality and excitement to every Zafira model. VXR styling products are available as a factory-fit option pack or accessories fitted by your Vauxhall retailer.



◀▶ **VXR Styling Pack.** Breathe some extra style into your Zafira with a front lower spoiler, side sills, rear roof spoiler* (above) and rear lower skirt. These items are also available separately as retailer-fit accessories.

**Standard on SRI.*

▶ Panoramic Roof Pack.**

- Four glass roof panels
- Roof mounted storage console for front and rear passengers
- Alloy-effect roof rails
- Heat-reflective windscreen

**Not available in conjunction with Olympic White exterior colour. Deletes sunglasses holder where fitted.



▲ FlexOrganiser® Pack.

- 3D storage net
- Side net pocket
- Four side rail hooks
- Four side rails



▲ Towing Pack.

- Detachable tow bar†
- Trailer stability programme
- Hill Start Assist (HSA)
- Tyre deflation detection system
- Cruise control

†Requires adaptor for UK electrics.

▲ Keyless entry and start. Simply carry the unique system key fob in your pocket or handbag and the car will automatically unlock as you operate a door or the tailgate. To start the engine, you depress the brake pedal and push the start button on the centre console and to stop the engine, simply press the button again.

OPTION PACKS INCLUDE:

Life/Exclusiv Plus Pack.

- 16-inch 10-spoke alloy wheels
- Front fog lights

Seat Comfort Pack One.

- Driver's seat tilt and lumbar adjustment

Seat Comfort Pack Two.

- Front passenger's seat height, tilt and lumbar adjustment

Leather Pack.

- Leather seat facings on front and second row seats. Third row trimmed in Morrocana.
- Electrically heated sports front seats with tilt and lumbar adjustment
- Front passenger's seat height adjuster



INDIVIDUAL OPTIONS INCLUDE:

- Adaptive Forward Lighting (AFL)
- Interactive Driving System (IDS) with Continuous Damping Control (CDC)
- Mobile phone system with Bluetooth†
- Twin Audio®##
- Satellite navigation system/CD player with MP3 format/auxiliary-in socket/stereo radio/colour graphic information display (CD 70)
- Alloy wheels
- Front and rear parking distance sensors

†Please refer to the online Vauxhall Car and Accessory Price Guide for a list of phone-specific cradles.

##Does not include headsets. Fitted with industry standard 3.5mm audio sockets.

Genuine Vauxhall accessories are the right choice for your Zafira. Whatever you're into, there's certain to be a Vauxhall accessory with your name on it; all fitted by trained Vauxhall professionals. We've only featured a small selection of what's available here, so please check with your Vauxhall retailer for accessory availability information or visit our website at www.vauxhall.co.uk



▲ Floor mats. A range of floor mats including rubber, velour and deluxe velour are available for your Zafira. Each come with their own fixing points which help keep them firmly in place. The rubber mats are available as a front pair or set of four rears whilst all other variants are supplied in sets of six.

▼ Base carrier. The Vauxhall roof rack system begins with a base carrier. It comprises two T-track bars which support a wide range of attachments from Thule including bicycle carriers and a choice of high-capacity roof boxes (available separately). Each carrier is supplied with locks for security.



▶ Rear parking distance sensors. Activated automatically as you select reverse, this clever system beeps faster the closer you get to an obstruction, changing to a continuous tone at 300mm away.

▶ Dog guard with space divider grid*. Designed to fit Zafira models, the heavy-duty steel dog guard helps keep your pet secure and protects passengers in the event of sudden braking. The space divider grid (sold separately) allows luggage to be stored on one side, and the dog to travel on the other.



**The space divider grid can only be used in conjunction with the dog guard. N.B. Dog guard requires fitting kit (retailer-fit only) if vehicle is not equipped with the optional factory-fit vertical load restraining net.*



FURTHER ACCESSORIES AVAILABLE INCLUDE:

- Thatcham approved alarm system
- Cargo liner
- Mudflaps
- Headlight protectors
- Electrically chilled 12-litre cool bag
- Thule bike carrier
- Thule alloy ski carrier
- Tow bar
- Anti-slip mat
- Steering wheel security bar
- Child seats
- Privacy shades
- Alloy wheels

VAUXHALL ACCESSORY PACKS

Vauxhall accessory packs bring together a selection of essential accessories at great prices, helping you to protect your car and equipping you for roadside emergencies.

irmscher Styling

Developed in conjunction with auto design specialists Irmischer International, Zafira styling accessories perfectly complement the vehicle's lines, as well as being manufactured to the same exacting standards as the car itself.



▶ **Irmischer sports silencers.**
For distinctive looks (with chrome-plated tailpipes) and a sportier exhaust note, these split oval design tailpipes are the perfect choice for your Zafira.



▲ ▶ **Protection Pack.**

- Velour mats
- Mudflaps
- Cargo liner



◀ **Irmischer alloy wheels.** They're the perfect way to personalise your Zafira. With a huge range to choose from (style illustrated is Stila), and sizes from 16 to 19 inches, you're sure to find one to suit your style and budget. And don't forget to ask about our accessory wheel locking kits too.



◀ **Safety Pack.**

- First aid kit
- Warning triangle
- Hi-visibility vest

▶ **Cross hatch grille.** Being different is easy with the cross hatch front grille from Irmischer. Featuring an aluminium upper strip with a laser-etched 'Irmischer' logo it adds style and individuality.



Zafira comes in 10 different exterior colours. And each one suits the car beautifully. Every trim combination – cloth or leather – has been carefully selected to complement whatever colour you choose.

Due to the limitations of the printing process the colours reproduced may vary slightly from the actual paint colour or trim material. As a result they should be used as a guide only. Vehicle illustrated is a non-specific model.

Your Vauxhall retailer has a comprehensive display of all our paint samples and trim swatches.

Power Red – solid (two-coat)



Olympic White – brilliant*



Sovereign Silver – metallic*



Silver Lightning – metallic*



Metro Blue – metallic*



Technical Grey – metallic*



Panacotta – pearlescent*



Ultra Blue – pearlescent*



Black Sapphire – pearlescent*



Waterworld – pearlescent*





◀ Alpha cloth – Charcoal
EXPRESSION/LIFE



◀ Twist cloth – Charcoal
EXCLUSIV

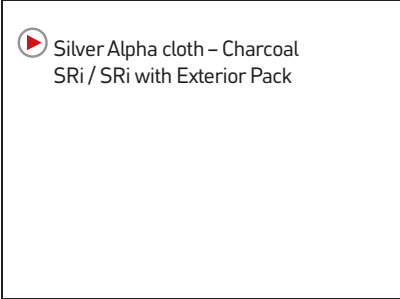

▶ Silver Alpha cloth – Charcoal
SRI / SRI with Exterior Pack



▶ Silver Alpha cloth/
Morrocana – Charcoal
DESIGN



◀ Leather – Charcoal**
ELITE / SRI† / SRI with Exterior Pack†

*Optional at extra cost. Not available on Expression models.
**Leather facings on front and second row seats. Third row seats trimmed in Morrocana.
†Optional at extra cost.

Contents

Equipment

Safety Security	34
-----------------	----

Interior features Facia, instruments and controls	35
--	----

Seating and upholstery Wheels and tyres	36
--	----

Mechanical Exterior and convenience features	137
---	-----

Option packs	38
--------------	----

Audio, communication and navigation	40
-------------------------------------	----

Technical data

Engines	42
---------	----

Performance, fuel economy and emissions	43
---	----

Vauxhall Assistance and warranties	44
------------------------------------	----

Optional transmissions	
------------------------	--

Steering	
----------	--

Brakes	
--------	--

Body	
------	--

Fuel tank capacity	
--------------------	--

Suspension	
------------	--

Weights and towing data	45
-------------------------	----

Keyless entry and start	
-------------------------	--

Exterior dimensions	46
---------------------	----

Luggage capacities	
--------------------	--

Loadspace dimensions	
----------------------	--

Features explained	47
--------------------	----

Safety

Standard features • Driver's and front passenger's airbags • Full-size curtain airbags (front and second-row seating) • Front seat side-impact airbags • Pedal release system – Reduces potential injury to the driver's legs and feet during a severe frontal impact • Laminated windscreen • Side-impact protection beams • Energy-absorbing steering column

• Child-proof locks on rear doors • ISOFIX child seat restraint system for outer second-row seats incorporating top tether (does not include child seat) – Secures ISOFIX child safety seats to the vehicle itself, virtually eliminating the dangers that can result from improper installation

• Electronic Stability Programme-plus (ESP-plus) with traction control – see **D2** on page 47 • Anti-lock Braking System (ABS) • Electronic Brakeforce Distribution (EBD) • Cornering Brake Control (CBC) • Emergency Brake Assist (EBA)

• Pyrotechnic front body-lock seatbelt pretensioner system – Tightens the seatbelt during the early stages of a frontal impact • Front seatbelt force limiters – Reduce the loading on the occupants' chests by releasing the belts very slightly, if the force exceeds a specified limit, in a frontal impact • Height-adjustable head restraints on all seats • Inertia-reel lap and diagonal seatbelts on all seats

Additional features

	Exp.	Life	Excl.	Design	Elite	SRi	SRi XP
Tyre deflation detection system			<input type="checkbox"/>	<input type="checkbox"/>	<input type="checkbox"/>	<input type="checkbox"/>	<input type="checkbox"/>
Hill Start Assist (HSA)			<input type="checkbox"/>	<input type="checkbox"/>	<input type="checkbox"/>	<input type="checkbox"/>	<input type="checkbox"/>

Security

Standard features • Remote control central deadlocking (doors, tailgate and fuel flap) • 'Key left in ignition' audible warning • Electronic engine deadlock immobiliser • Locking wheel bolts for alloy wheels (where fitted) • Electronic theft protection for audio equipment

Additional features

	Exp.	Life	Excl.	Design	Elite	SRi	SRi XP
Keyless entry and start system – see D1 on page 45			<input type="radio"/>	<input type="radio"/>	<input type="radio"/>	<input type="radio"/>	<input type="radio"/>
Remote control ultrasonic security alarm system						●	●

Interior features

Standard features • Air blend heater with four-speed fan and illuminated controls • Interior pollen filter • Interior odour-reducing activated charcoal filter • Air recirculation system with activation light • Second-row passenger compartment heating outlets • Drinks holder in centre console • Front and rear door pockets • Front sill storage bins • Drinks holders in second-row door pockets and third-row seat side armrests • Latched storage lockers in luggage compartment • 12-volt auxiliary power socket in luggage compartment • Retractable luggage compartment cover

Additional features	Exp.	Life	Excl.	Design	Elite	SRi	SRi XP
Air conditioning		● ¹	●	●		●	●
Electronic Climate Control (ECC) with graphic information display			○		●	○	○
Third-row passenger compartment reading lights and front map-reading lights integral with courtesy light			●	●	●	●	●
Charcoal-effect inserts on facia and doors	●	●					
Matt chrome-effect centre console	●	●				●	●
Matt chrome-effect inserts on facia and doors			●				
Maze chrome-effect inserts on facia and doors						●	●
Piano black-effect centre console			●	●	●		
Satin chrome-effect inserts on facia and doors				●	●		
Brushed aluminium door sill covers				●	●	●	●
Electro-chromatic anti-dazzle rear-view mirror				●	●		
Driver's sunglasses holder ²				●	●	●	●
Vertical load-restraining net	○	○	○	○	○	○	○

Facia, instruments and controls

Standard features • Steering column adjustable for reach and rake • Rev counter • Electronic odometer and trip odometer • Digital clock with automatic RDS time adjustment • Service-due indicator • Multi-function display panel showing time, date, audio information and outside air temperature (with ice warning function) • 12-volt electrical accessory socket

Additional features	Exp.	Life	Excl.	Design	Elite	SRi	SRi XP
Multi-function trip computer				●	●	●	●
Black instrument dials	●	●	●	●	●		
Black instrument dials with chrome edging						●	●
Three-spoke steering wheel	●	●					
Leather-covered three-spoke steering wheel			●	●	●		
Leather-covered three-spoke sports steering wheel						●	●
Cruise control			○	○	●	○	○
Sport switch		● ³	● ³	● ³		●	●



Sport switch.

● = Standard equipment.
 ○ = Optional at extra cost.
 □ = Only available as part of an extra-cost option pack (see page 38 for details).
 Exp. = Expression.
 Excl. = Exclusiv.
 SRi XP = SRi with Exterior Pack.

1 = Non-air conditioned 1.6i 16v VVT models also available.
 2 = Deleted if optional Panoramic Roof Pack is specified.
 3 = Standard on 1.8i 16v VVT Easytronic models.



18-inch five-spoke alloy wheels.



17-inch five-spoke alloy wheels.

Seating and upholstery (see pages 33 for more details)

Standard features • Flex7® seating system • Reclining front seats • Driver's seat height adjuster • 40/20/40 split-folding second-row seat back • Second-row seats with sliding function plus fold and stow facility • Multi-function fold-down second-row centre seat • Two individual fold-flat third-row seats • Carpeted passenger compartment, load area floor and rear seat backs

Additional features	Exp.	Life	Excl.	Design	Elite	SRi	SRi XP
Alpha cloth seat trim	●	●					
Twist cloth seat trim			●				
Silver Alpha cloth seat trim with Morrocana-trimmed side bolsters				●			
Silver Alpha cloth seat trim						●	●
Leather seat facings on front and second-row seats, Morrocana seat facings on third-row seats					●	□	□
Sports front seats					●	●	●
Driver's seat with tilt and lumbar adjustment			□	●	●	●	●
Front passenger's seat with tilt and lumbar adjustment			□	□	●	□	□
Driver's armrest				●	●	●	●
Heated front seats					●	□	□
Storage pockets on front seat backs			●	●	●	●	●

Wheels and tyres

Features	Exp.	Life	Excl.	Design	Elite	SRi	SRi XP
16-inch steel wheels with flush covers and 205/55 R 16 ultra-low profile tyres	●	●					
16-inch Structure wheels with 205/55 R 16 ultra-low profile tyres			●				
16-inch 10-spoke alloy wheels with 205/55 R 16 ultra-low profile tyres and locking bolts		□	□				
16-inch seven twin-spoke alloy wheels with 205/55 R 16 ultra-low profile tyres and locking bolts				●	●		
17-inch five-spoke alloy wheels with 225/45 R 17 ultra-low profile tyres and locking bolts						●	
18-inch five-spoke alloy wheels with 225/40 R 18 ultra-low profile tyres and locking bolts						○	●
Steel spare wheel (deletes 12-volt auxiliary power socket in luggage compartment)	○	○	○	○	○	○ ⁴	
Emergency tyre inflation kit in lieu of spare wheel	●	●	●	●	●	●	●

Mechanical

Features	Exp.	Life	Excl.	Design	Elite	SRi	SRi XP
Five-speed manual gearbox (1.6i 16v VVT/1.8i 16v VVT)	●	●	●	●	●	●	●
Six-speed manual gearbox (1.7CDTi 16v (110PS)/1.7CDTi 16v (125PS))		●	●	●	●	●	●
Five-speed Easytronic transmission (1.8i 16v VVT)		○	○	○			
Sports suspension						●	●
Interactive Driving System-plus (IDS-plus) with Continuous Damping Control (CDC) – see D3 on page 47						○	○

Exterior and convenience features

Standard features • Green-tinted glass • Electrically operated front windows with safety autoreverse and one-touch facility • Intermittent rear window wash/wipe • Electrically adjustable door mirrors • Electric headlight beam levelling • H7 halogen headlights • Body-colour door mirrors • Body-colour bumpers

Additional features	Exp.	Life	Excl.	Design	Elite	SRi	SRi XP
Folding key			●	●	●	●	●
Rain-sensitive windscreen wipers/Automatic Lighting Control (ALC)				●	●		
Dark-tinted glass (excludes windscreen and front door windows)			●	●	●	●	●
Electrically operated rear windows with safety autoreverse				●	●	●	●
Black foil on door pillars (not available with Black Sapphire pearlescent paint)			●	●	●	●	●
Black roof rails ⁵		●	●				
Alloy-effect roof rails ⁵			□	●	●	●	●
Front fog lights		□	□	●	●	●	●
Electrically heated door mirrors			●	●	●	●	●
Electrically foldable door mirrors				○	○	○	○
Black side-protection mouldings	●	●					
Body-colour side-protection mouldings/door handles/tailgate handle			●	●	●	●	●
Body-colour rear roof spoiler			□	□	□	●	●
VXR Styling Pack – see page 38 for details			□	□	□	□	●
Dark-style headlights	●	●	●			●	●
Chrome-effect headlights				●	●		
Adaptive Forward Lighting (AFL) incorporating dark-style bi-xenon headlights with dynamic beam levelling and high-pressure headlight washers – see D4 and D5 on page 47			○ ⁶	○	○	○	○
Front and rear parking distance sensors			○	○	○	○	○
Heat-reflective windscreen			□	□	●	□	□



Folding key.

● = Standard equipment.
○ = Optional at extra cost.
□ = Only available as part of an extra-cost option pack (see page 38 for details).
Exp. = Expression.
Excl. = Exclusiv.
SRi XP = SRi with Exterior Pack.

4 = Not available on models fitted with optional 18-inch alloy wheels.

5 = Must be used with separate base carrier (available as a Vauxhall accessory) if luggage is to be carried on the roof.

6 = AFL includes front fog lights on Exclusiv models.

● = Standard equipment.
 ○ = Optional at extra cost.
 Exp. = Expression.
 Excl. = Exclusiv.
 SRi XP = SRi with Exterior Pack.

5 = Must be used with separate base carrier (available as a Vauxhall accessory) if luggage is to be carried on the roof.
 7 = Not available with Olympic White exterior colour. Deletes sunglasses holder where fitted.
 8 = Only available in conjunction with Seat Comfort Pack One.
 9 = Requires 13-pin adaptor (available as a Vauxhall accessory).

Option packs

	Exp.	Life	Excl.	Design	Elite	SRi	SRi XP
Plus Pack ● 16-inch 10-spoke alloy wheels with 205/55 R 16 ultra-low profile tyres and locking bolts ● Front fog lights		○	○				
Leather Pack ● Leather seat facings on front and second-row seats. Morrocana seat facings on third-row seats ● Electrically heated sports front seats with tilt and lumbar adjustment ● Front passenger's seat height adjuster					●	○	○
Panoramic Roof Pack ⁷ ● Four glass roof panels ● Roof-mounted storage console for front and rear passengers ● Alloy-effect roof rails (Exclusiv) ⁵ ● Heat-reflective windscreen			○	○	○	○	○
Seat Comfort Pack One ● Driver's seat with tilt and lumbar adjustment			○	●	●	●	●
Seat Comfort Pack Two ● Front passenger's seat with tilt, height and lumbar adjustment			○ ⁸	○	●	○	○
Towing Pack ⁹ ● Trailer stability programme ● Hill Start Assist (HSA) ● Tyre deflation detection system ● Cruise control ● Detachable tow bar			○	○	○	○	○
VXR Styling Pack ● Body-colour lower front spoiler/rear lower skirt/rear roof spoiler (standard on SRi) and side sills			○	○	○	○	●
FlexOrganiser [®] Pack ● 3D storage net ● Side net pocket ● Four side rail hooks ● Four side rails			○	○	○	○	○

Plus Pack

- 16-inch 10-spoke alloy wheels with 205/55 R 16 ultra-low profile tyres and locking bolts
- Front fog lights



Leather Pack

- Leather seat facings on front and second-row seats. Morrocana seat facings on third-row seats
- Electrically heated sports front seats with tilt and lumbar adjustment
- Front passenger's seat height adjuster



Panoramic Roof Pack⁷

- Four glass roof panels
- Roof-mounted storage console for front and rear passengers
- Alloy-effect roof rails (Exclusiv)⁵
- Heat-reflective windscreen

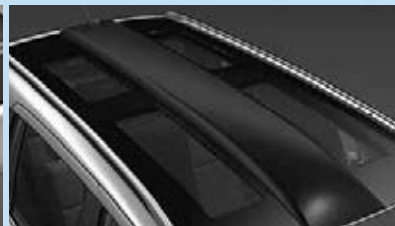

Seat Comfort Pack One

- Driver's seat with tilt and lumbar adjustment



Seat Comfort Pack Two⁸

- Front passenger's seat with tilt, height and lumbar adjustment



Towing Pack⁹

- Trailer stability programme
- Hill Start Assist (HSA)
- Tyre deflation detection system
- Cruise control
- Detachable tow bar

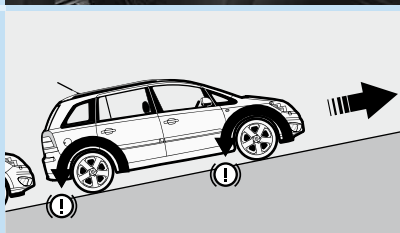

VXR Styling Pack

- Body-colour lower front spoiler/rear lower skirt/rear roof spoiler (standard on SRi) and side sills

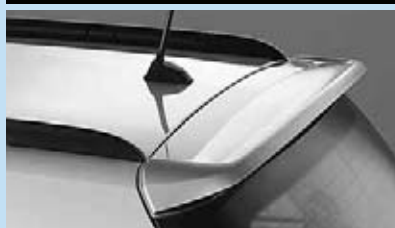

FlexOrganiser[®] Pack

- 3D storage net
- Side net pocket
- Four side rail hooks
- Four side rails



FlexOrganiser[®] accessories

Vauxhall also offers a range of FlexOrganiser[®] features as part of its comprehensive collection of accessories.

For details of FlexOrganiser[®] accessories, shown right, please consult your Vauxhall retailer.



● = Standard equipment.
 ○ = Optional at extra cost.
 Exp. = Expression.
 Excl. = Exclusiv.
 SRi XP = SRi with Exterior Pack.

10 = Not available in conjunction with VXR Styling Pack.
 11 = Only available in conjunction with VXR Styling Pack.
 12 = Includes map reading light, sunvisors with illuminated vanity mirrors and rear reading lights.
 13 = Steering wheel mounted audio controls are also included on Life models.
 14 = Only available in conjunction with optional audio units. Deletes auxiliary-in socket (where fitted).
 15 = Deletes auxiliary-in socket.



Steering wheel mounted audio controls.

Audio, communication and navigation

Features	Exp.	Life	Excl.	Design	Elite	SRi	SRi XP
CD player/stereo radio (CD 30) ● CD player ● AM/FM stereo radio with 24 station presets ● RDS with Traffic Programme ● Remote display ● 17 watts per channel output ● 6 speakers	●	●	●	●		●	●
CD player with MP3 format/stereo radio (CD 30 MP3) ● CD player with MP3 format ● Auxiliary-in socket ● AM/FM stereo radio with 24 station presets ● RDS with Traffic Programme ● Remote display ● 20 watts per channel output ● 7 speakers		○	○	○	●	○	○
CD autochanger with MP3 format/DAB stereo radio (CDC 40 DAB) (deletes auxiliary-in socket, where fitted) ● Integral six-disc CD autochanger with MP3 format ● AM/FM/DAB (Digital Audio Broadcast) stereo radio with 36 station presets ● RDS with Traffic Programme ● Remote graphic information display ● 35 watts per channel output ● 7 speakers			○ ¹⁰	○ ¹⁰	○ ¹⁰		
CD autochanger with MP3 format/stereo radio (CDC 40) (deletes auxiliary-in socket, where fitted) ● Integral six-disc CD autochanger with MP3 format ● AM/FM stereo radio with 36 station presets ● RDS with Traffic Programme ● Remote graphic information display ● 35 watts per channel output ● 7 speakers			○ ¹¹	○ ¹¹	○ ¹¹	○	○
Satellite navigation/CD player with MP3 format/stereo radio (CD 70) ● Satellite navigation system ● CD player with MP3 format ● Auxiliary-in socket ● AM/FM stereo radio with 40 station presets ● RDS with Traffic Programme ● Remote colour display ● 20 watts per channel output ● 7 speakers		○ ^{12,13}	○	○	○	○	○
Rear seat Twin Audio [®] system			○ ¹⁴	○ ¹⁴	○ ¹⁵	○ ¹⁴	○ ¹⁴
Mobile phone system with Bluetooth [®] (does not include phone or cradle)		○ ^{12,13}	○	○	○	○	○
Steering wheel mounted audio controls			●	●	●	●	●
Roof-mounted flexible aerial	●	●	●	●	●	●	●

Twin Audio[®] system

The Twin Audio[®] system allows the two rear passengers to listen to the same music source (i.e. radio or CD) through personal headphones, independently of one another and each with their own volume controls.

They are also free to select CD mode while the front occupants are tuned into the radio (or vice-versa) and make full use of functions like track skip and autosearch.



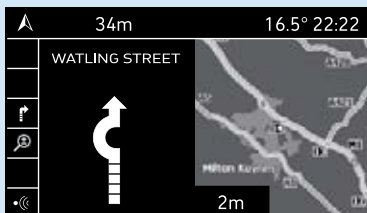

Satellite navigation

The CD 70 satellite navigation system uses the international network of GPS (Global Positioning System) satellites, linked to a comprehensive CD-ROM mapping system, to determine your precise location and guide you to your chosen destination virtually anywhere in mainland Britain.

Vauxhall's satellite navigation systems have been widely acclaimed for their ease of use and high level of information. There are three screen styles – pictographic, split-screen pictographic/map and map only. The split-screen facility displays the route as a map, while directional arrows give immediate information about road junctions. The display also allows you to vary the map scale – close-up for town driving or a wider scale for long distances, if required.

The CD 70 also features Traffic Message Channel (TMC), a specific application of RDS used for broadcasting real-time traffic information, delivered to the driver either visually or verbally. TMC can also offer dynamic route guidance – alerting the driver to a problem on the planned route and calculating an alternative route to avoid the incident.

CD 70 standard features

- Split-screen facility displaying directional symbols and route on map
- Audio/voice direction guidance prompt
- Automatic re-routing on request
- CD-ROMs available for all major European countries
- Option of destination entry via partial postcode
- Display of estimated time remaining and distance to destination
- Points of interest, including attractions, petrol stations, airports, hotels, restaurants, etc
- Store up to 100 personal destinations
- Last 10 destinations stored automatically
- Traffic Message Channel (TMC)

Digital Audio Broadcast (DAB) facility

Now widely available in the UK, digital audio broadcasts offer the user a variety of advantages over traditional FM, starting with the digital quality sound which is immune to any hiss or crackle.

You'll often find a broader range of stations on offer too, many of which are not available on FM, and listening to them couldn't be easier – you simply select the station, by name, from the displayed list, thus removing the need to retune or look for stations when travelling around. Some stations will even display the artists' names and song titles on the car's graphic display, while they're played.

MP3 CD player

An MP3 is a compressed sound or music file and, due to its small size, it takes up less space on a compact disc, which means that more tracks can be recorded onto a CD. It's possible to fit almost 10 hours of music onto one CD, and, in a way, turns a single-disc CD/MP3 player into a multi-disc autochanger.

Mobile phone system with Bluetooth®

Vauxhall's optional factory-fit dual-band mobile phone system has been considerably enhanced. Now fully integrated into the audio and communication system, it also features voice control and will connect wirelessly to phones with Bluetooth® technology.

All the required information is displayed on the graphic information display when a mobile phone is in use, while the menus are easily navigated by either the steering wheel audio controls or the multi-function button on the radio. Certain functions can also be controlled by voice activation.

The mobile phone system can be further enhanced by fitting a phone-specific cradle, available as a Vauxhall Accessory. The cradle offers a secure location for your phone, while simultaneously charging the phone's battery and connecting its antenna to the car's external aerial. A list of compatible cradles is featured in the online Vauxhall Car and Accessory Price Guide.

Auxiliary-in socket

The auxiliary-in socket allows you to connect your portable MP3 music player directly into the car's audio system. All you need is your music player and a suitable connecting lead and you can listen to all your favourite tunes through your car's speaker system.

When using an MP3 player in the car the majority of the controls, such as track selection, remain solely on the player, while only the volume is controlled via the car's regular audio controls.

NB: Auxiliary-in socket is not available in conjunction with CDC 40 audio units.



CD 70 satellite navigation system.



Mobile phone system with Bluetooth®.

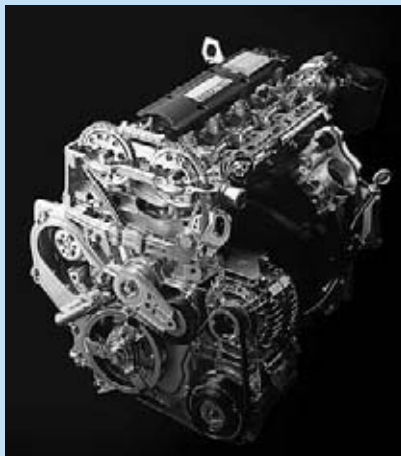

High-performance petrol engines.



55.4mpg

1.7CDTi 16v
ecoFLEX engine
offers great
economy and low
emissions

Petrol engines

	1.6i 16v VVT ECOTEC-4	1.8i 16v VVT ECOTEC-4
Capacity	1598cc	1796cc
Maximum power	115PS (85kW) @ 6000rpm	140PS (103kW) @ 6300rpm
Maximum torque	155Nm (114 lb.ft.) @ 4000rpm	175Nm (129 lb.ft.) @ 3800rpm
Configuration	4 cylinders, 4 valves per cylinder, double overhead camshafts	
Fuel/induction system	Naturally aspirated Variable Valve Timing (VVT). Multi-point sequential fuel injection	
Emission compliance	Euro 5	
Service intervals	20,000 miles or 1 year (whichever occurs sooner)	
Benefit in kind company car taxation - 2011/12 tax year		
Manual	21%	23%
Easytronic	-	22%

Diesel engines

	1.7CDTi 16v (110PS) ECOTEC-4 Turbo diesel with DPF	1.7CDTi (125PS) ECOTEC-4 Turbo diesel with DPF
Capacity	1686cc	1686cc
Maximum power	110PS (81kW) @ 3800rpm	125PS (92kW) @ 4000rpm
Maximum torque	260Nm (192 lb.ft.) @ 2300rpm	280Nm (206 lb.ft.) @ 2300rpm
Configuration	4 cylinders, 4 valves per cylinder, double overhead camshafts	
Fuel/induction system	Variable geometry turbocharger with intercooler. Common rail fuel injection	
Emission compliance	Euro 5	
Service intervals	20,000 miles or 1 year (whichever occurs sooner)	
Benefit in kind company car taxation - 2011/12 tax year		
Manual	19%	19%

DPF = Diesel Particulate Filter.

Performance, fuel economy and emissions

Model	Performance (manufacturer's figures) Acceleration (secs)			Fuel economy mpg (litres/100km)			CO ₂ emissions (g/km)	VED*	
	Max. speed (mph)	0-60mph	30-50mph (4th gear)	Urban driving	Extra- urban driving	Combined figure		First year rate	Standard rate
<i>Manual 5-speed</i>									
1.6i 16v VVT	115	12.5	9.1	32.5 (8.7)	51.4 (5.5)	42.2 (6.7)	157	£165	£165
1.8i 16v VVT	122	10.8	8.1	29.4 (9.6)	49.6 (5.7)	39.2 (7.2)	168	£265	£190
<i>Manual 6-speed</i>									
1.7CDTi 16v (110PS) ecoFLEX	111	12.5	7.3	46.3 (6.1)	62.8 (4.5)	55.4 (5.1)	134	£115	£115
1.7CDTi 16v (125PS) ecoFLEX	117	11.5	6.7	46.3 (6.1)	62.8 (4.5)	55.4 (5.1)	134	£115	£115
<i>Easytronic 5-speed</i>									
1.8i 16v VVT	122	12.1	–	29.4 (9.6)	51.4 (5.5)	40.4 (7.0)	164	£165	£165

* = Correct at time of publication (April 2011).

Fuel consumption and CO₂ emission data complies with the relevant EU regulations. **Important:** the results given relate to the particular vehicle tested; inevitably there are differences between individual vehicles of the same model. Driving style, road and traffic conditions, vehicle mileage and standard of maintenance may also affect fuel consumption.

Vauxhall supporting



Smarter driving tips

- **Drive at an appropriate speed:** – Staying within the speed limit increases driver safety, reduces CO₂ emissions and saves fuel. At 70mph you could be using up to 9% more fuel than at 60mph and up to 15% more fuel than at 50mph
- **Drive smoothly at all times:** – Anticipate the ebb and flow of the traffic to avoid harsh acceleration and braking

- **Reduce your revs:** – Change gear earlier to help reduce fuel consumption – try 2500rpm with petrol engines and 2000rpm with diesel
- **Idling is wasting fuel:** – If you're likely to be at a standstill for more than three minutes, switch off the engine to save fuel
- **Regularly check your tyre pressures:**
 - Under inflated tyres increase CO₂ emissions whilst incorrectly inflated

tyres can be unsafe. Always check your handbook for the correct tyre pressure. This will also help to increase the life of your tyres

- **Remove unnecessary items from the car:** – Extra weight increases the engine's workload, whilst roof racks and bike carriers increase wind resistance. All burn more fuel and increase CO₂ emissions

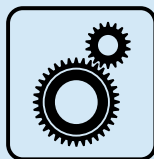

6-SPEED

Six-speed manual gearbox available



MacPherson strut front suspension.

Optional transmissions

Five-speed Easytronic transmission –

1.8i 16v VVT models: Easytronic is a five-speed manual gearbox with a fully automatic mode. In manual mode you simply push the lever forward or back to shift gears up or down, while the fascia display tells you what gear you're in. Switch to fully automatic mode and you'll have many of the features of a regular automatic, including kickdown. Since there's no clutch pedal, Easytronic is ideal for effortless town driving.

Steering

- Electro-hydraulic power-assisted steering
- Turning circle (kerb-to-kerb):
All models – 11.10m (36.4ft.)

Brakes

- Anti-lock Braking System (ABS)
- Dual circuit, diagonally split braking system

1.6i 16v VVT

Front ventilated discs: 280mm diameter

Rear discs: 264mm diameter

1.8i 16v VVT

Front ventilated discs: 280mm diameter

Rear discs: 264mm diameter

1.7CDTi 16v (110/125PS)

Front ventilated discs: 308mm diameter

Rear discs: 264mm diameter

Body

- Aerodynamic drag co-efficient: Cd 0.31

Fuel tank capacity

- All models – 58 litres (12.8 gallons)

Suspension

Front: Independent. Lightweight MacPherson struts with gas-pressure dampers and coil springs. Anti-roll bar. Hydro-formed subframe offers increased lateral stiffness. Hydraulic control arm bushing gives improved insulation from road noise.

- SRI models – uprated springs and dampers
- SRI – Interactive Driving System with Continuous Damping Control, optional at extra cost – see **D3** on page 47

Rear: Lightweight torsion beam rear axle with one-piece, hollow cast trailing arms. Built-in anti-roll bar. Progressive-rate double conical mini-block springs and gas-pressure dampers.

- SRI models – uprated springs and dampers
- SRI – Interactive Driving System with Continuous Damping Control, optional at extra cost – see **D3** on page 47

Vauxhall Assistance and warranties

See back cover for details of our comprehensive warranties.



Weights and towing data kg

	Gross vehicle weight	Max. towing weights Trailer with brakes (without brakes)
1.6i 16v VVT Expression/Life (non-air conditioned)	2075	1000 (750)
1.6i 16v VVT Life/Exclusiv/Design	2090	1000 (750)
1.8i 16v VVT Life/Exclusiv/Design/Elite (inc. Easytronic)	2095	1200* (750)
1.8i 16v VVT SRi	2095	1200 (750)
1.7CDTi 16v (110PS) Life/Exclusiv/Design/Elite	2175	1300 (750)
1.7CDTi 16v (125PS) Life/Exclusiv/Design/Elite/SRi	2175	1400 (750)

* = On models fitted with the optional Easytronic transmission the maximum towing weight for a trailer with brakes is 1300kg.

Gross vehicle weight is the total permissible weight of the vehicle including passengers and their luggage. The **maximum roof rack loading** should not exceed 75kg. The **maximum towing weights** are based on the ability of the car, with two occupants of 75kg each, to restart on a 12% gradient, which is approximately 1 in 8.3, at sea level. At altitudes above 1500 metres, the engine output may drop with a corresponding reduction in towing capability. Any extra weight, such as luggage or additional passengers, should be deducted from the maximum towing weight. With a trailer fully loaded, **maximum noseweight** should not exceed 75kg. Always fit Vauxhall towing attachments and accessories available from your Vauxhall retailer.



1400kg
Maximum
towing weight

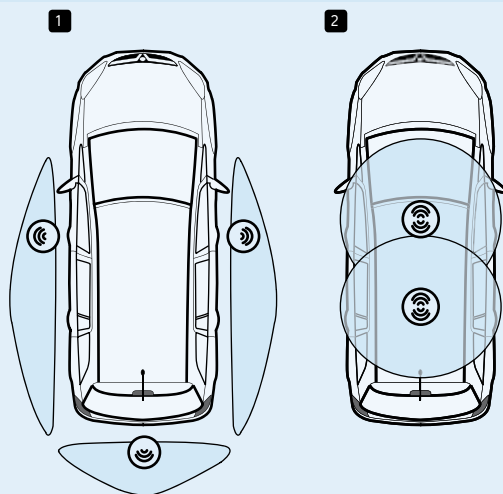

D1

Keyless entry and start

D1. Available as an option, the keyless entry and start system means that the driver need never remove their key fob from their pocket. When approaching the car, sensors in the front door handles and rear bumper **1** detect the driver's proximity and automatically unlock the doors or boot when the handle is pulled.

When in the car, two internal sensors **2** activate the ignition and release the electronic steering lock, enabling the driver to start or stop the engine by pressing the facia-mounted Start/Stop button. As an added safety feature, the engine will only start if the driver presses the foot brake while pushing the Start/Stop button.

Upon leaving the vehicle, the driver can lock it by either pressing a button on the key fob like a conventional system, or by simply touching one of the sensors on the external handles of the front doors.

Additionally the system offers excellent theft protection by its use of sophisticated cryptographic algorithms, while a back-up key is also included for emergency use.

Exterior dimensions millimetres (inches)

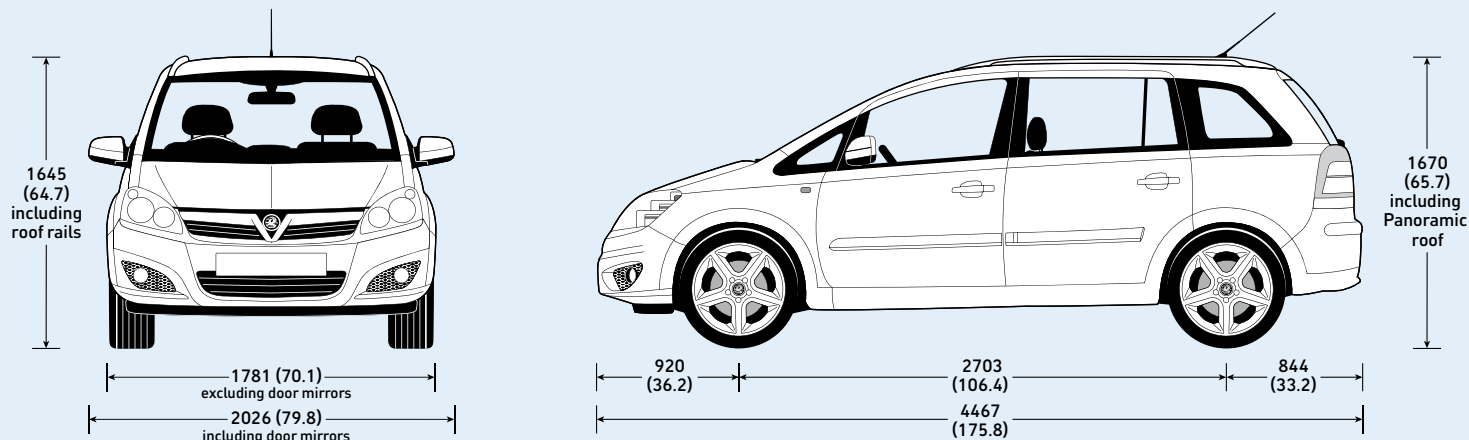

Luggage capacities (measured using the ECIE method)

	litres	cu.ft
Behind third-row, to glass line	140	4.9
Behind second-row, to glass line	645	22.8
Behind front seats, to glass line	1070	37.8
Behind front seats, to roof	1820	64.3

Loadspace dimensions

	mm	inches
Maximum floor length – behind front seats, second-row seat back lowered	1809	71.2
Maximum floor length – behind front seats, second-row seat folded and stowed	1525	60.0
Maximum floor length – behind second-row seat	1088	42.8
Maximum floor length – behind third-row seat	405	15.9
Maximum floor width	1114	43.9
Width between wheel arches	1071	42.2
Tailgate aperture height	893	35.2
Tailgate aperture width	1136	44.7



1820 litres
Maximum luggage capacity

Features explained

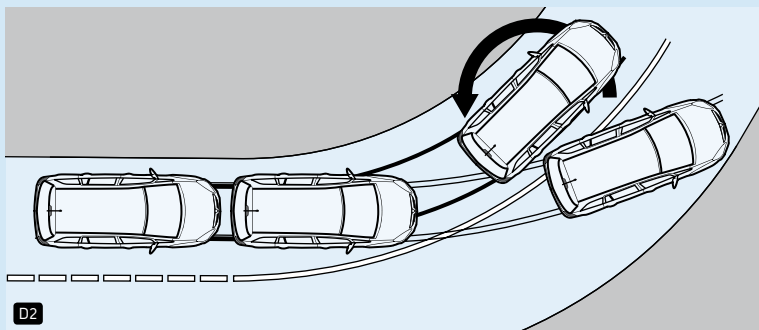

Electronic Stability Programme-plus (ESP-plus)

D2. ESP-plus provides enhanced yaw compensation during understeer or oversteer. It works by monitoring the front and rear of the car and comparing their respective directions of travel with the input through the steering wheel. If the vehicle starts to slide, ESP-plus applies corrective braking to the appropriate wheel, or wheels, compensating for the slide and helping you regain control more rapidly. ESP-plus offers additional safety in the form of two-way traction control, which helps prevent the driving wheels from spinning, under acceleration, on slippery surfaces.

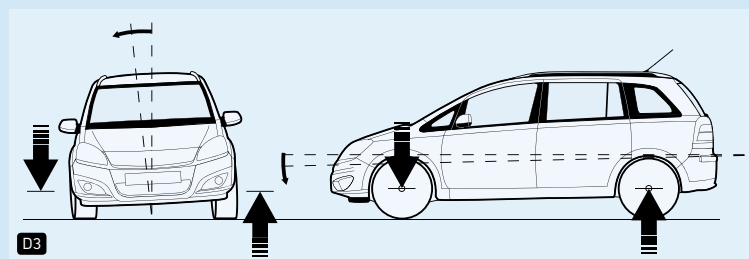

IDS-plus with Continuous Damping Control (CDC)

D3. The Interactive Driving System (IDS-plus) chassis – available on SRi and SRi XP models – offers the Zafira driver an even more sporting driving experience, thanks mainly to the electronic control of the suspension. Pressing the Sport switch activates the CDC function – CDC monitors the roll, pitch and yaw of the car, and changes the rate of damping on each wheel to optimise the handling, effectively stiffening the suspension – but selectively. This means the vehicle will exhibit a reduced rate of roll and pitch, making it more responsive during direction changes and more settled during the braking/turn-in/acceleration transition when cornering. CDC is a major breakthrough in the Zafira segment.

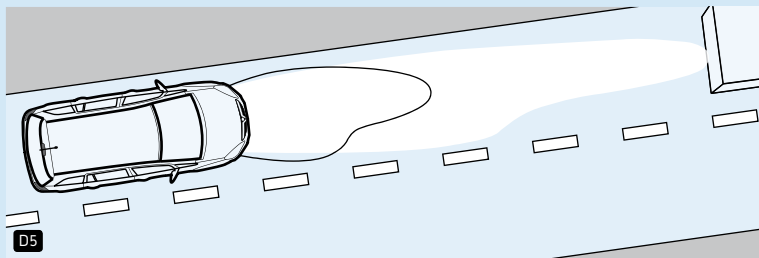
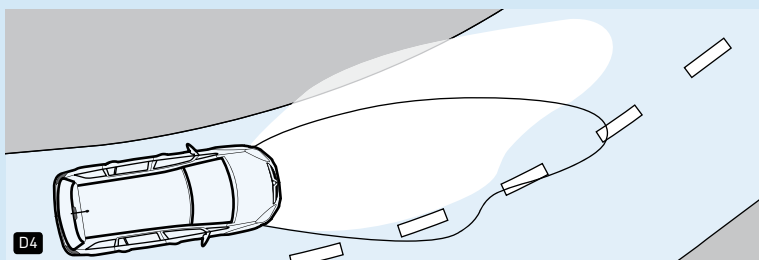

Bi-xenon Adaptive Forward Lighting (AFL)

Adaptive Forward Lighting is a sophisticated new lighting system that allows drivers to see around corners. AFL utilises powerful bi-xenon headlights – which offer up to three times more light output than conventional halogen headlights – to enable the full benefit of the system's advantages to be appreciated. While standard xenon headlights provide only dipped beam lighting (main beam illumination still uses conventional halogen lights), bi-xenon units provide both dipped and main beam from a single lighting unit. The package is completed by high-pressure headlight washers and dynamic beam levelling.

Curve light

D4. Controlled by a combination of steering wheel movement and sensors for the vehicle's speed and yaw angle, the Curve light function allows the headlight beam to move up to 15 degrees left or right of the straight ahead position. This ensures the light is always following the trajectory plotted by the front wheels, rather than simply pointing straight ahead.

Motorway light

D5. At speeds above 65mph, AFL raises the dipped headlight beam to extend the range of vision for increased safety at higher speed. The beam automatically returns to its normal position when the car falls below that speed.

Trust Vauxhall

Protecting the environment

Vauxhall's commitment to the environment is demonstrated by our products' many environmental awards, won both through the use of more recycled materials and by becoming cleaner and more efficient. For information on Vauxhall's efforts to achieve an environmentally sustainable future, see www.vauxhall.co.uk/recycling

Fleet Customer Services

Our dedicated support services for fleet managers includes factory demonstrators, a three-day test drive programme and information on whole life costs, company car taxation and finance. For further information please call **0870 010 0651**.



When you have finished with this brochure please recycle it

Buying your car

GMAC offers one of the most comprehensive and competitive ranges of financing plans in the UK. Contact your local Vauxhall retailer for details or call the GMAC customer service centre on **0845 712 3444**.

Servicing and maintenance

The best way to maximise the performance and reliability of your Vauxhall is to have all routine servicing and maintenance carried out at one of around 400 Vauxhall retailers. To find your nearest retailer call **0845 600 1500**.

In the event of an accident...

Vauxhall Accident Support helps keep you mobile following an accident. Benefits include scene-of-accident advice, message service, assistance with claims and vehicle recovery. For further details call **0800 010 304**.

Vauxhall Insurance

Available for new and used Vauxhalls, a Vauxhall Insurance policy offers a unique package designed specifically for Vauxhall drivers. For a highly competitive quotation, call **0844 84 85 840** (Great Britain) or **0845 35 13 410** (N. Ireland). Or just visit our website at www.vauxhall.co.uk

For more information...

For a brochure on any Vauxhall model (up to a maximum of three per caller) or location of your nearest Vauxhall retailer please **Lo-call 0845 600 1500**.

Alternatively, details can be found on our website at www.vauxhall.co.uk

Proud Sponsor of Home Nations Football



Vauxhall Lifetime Warranty



We're so confident in Vauxhall quality and reliability

that we are now able to offer a warranty that could last a lifetime. Available to the first owner of all new Vauxhall passenger cars, it's valid for the lifetime of the vehicle up to a maximum of 100,000 miles*. In addition, our warranty also includes Vauxhall Assistance for 12 months from first registration and six years body panel anti-perforation warranty. Full details of Vauxhall's warranties including terms, conditions and exclusions can be obtained through any authorised Vauxhall Retailer or go to www.vauxhall.co.uk/warranty

*Vauxhall Lifetime Warranty covers lifetime ownership of first car owner; 100,000 mile limit, annual check required. The warranty excludes wear and tear and serviceable items and the vehicle must be serviced in accordance with the manufacturer's servicing schedule to continue the lifetime warranty. Terms and conditions apply. Offer available to all Vauxhall passenger cars (this offer does not apply to car-derived vans) from 1st August 2010.

Every effort has been made to ensure that the contents of this publication were accurate and up-to-date at the time of going to press (April 2011). Vauxhall vehicles are equipped with components manufactured by various General Motors operating units and outside suppliers. The Company reserves the right to alter specifications and withdraw products from sale without notice. Any such alterations will be notified to Vauxhall retailers at the earliest opportunity; please consult your local retailer for the latest information. The specifications detailed within this brochure are not necessarily applicable to alternative models such as Special Editions. Details of any such models will be contained in specific literature or found on the Vauxhall website. Please note that Vauxhall retailers are not the agents of General Motors UK Limited and are not authorised to bind the Company by any specific or implied undertaking or representation. It is advisable to ensure that your motor insurance policy provides adequate cover for additional fitted options and accessories. Please note accessories shown are for illustrative purposes only. As part of Vauxhall's policy of environmental care, this brochure is printed on paper manufactured using Elemental Chlorine Free pulps from specially farmed, sustainable timber resources. All rights reserved. No part of this publication may be reproduced in any form or by any means, without the prior written permission of General Motors UK Limited.

