

ADAM

PRICE/SPECIFICATION GUIDE

20 November 2018 | Model Year 2019.5

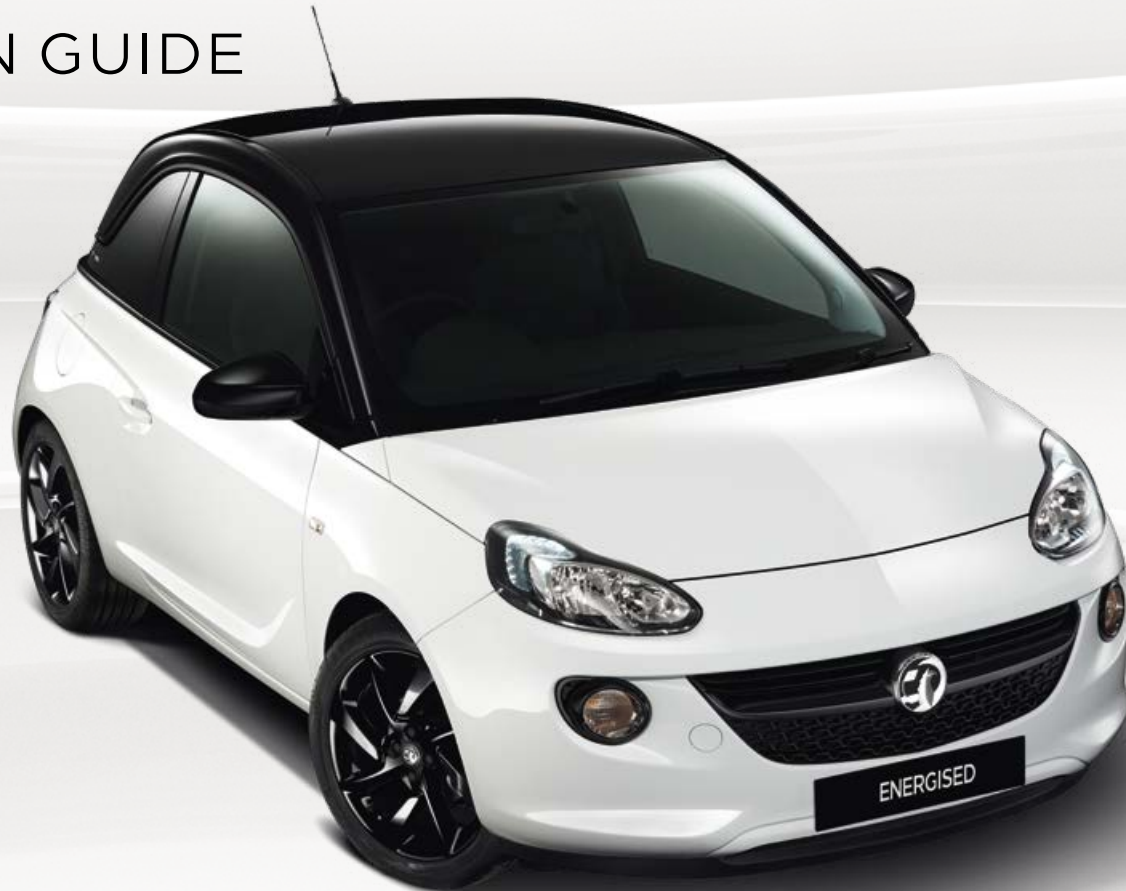

VAUXHALL

British Brand since 1903

ADAM RANGE HIGHLIGHTS



JAM OTR from £13,450

Standard features include:

Infotainment:

- CD 30 BT audio system
 - AM/FM radio
 - CD/MP3 CD player
 - Bluetooth® audio streaming
 - Bluetooth® mobile phone portal
 - USB audio connection
 - Aux-in socket

Interior convenience / styling:

- Air conditioning
- Cruise control
- Leather-covered steering wheel
- Steering wheel audio / phone / cruise controls
- Multi-function trip computer

Exterior convenience / styling:

- 16-inch alloy wheels
- Electrically operated front windows
- Electrically adjustable / heated door mirrors

Safety / security features:

- Electronic Stability Programme (ESP)
- Anti-lock Braking System (ABS)
- Tyre pressure monitoring system
- Six airbags
- Daytime running lights
- Remote control central deadlocking



ENERGISED OTR £15,295

Standard features include:

Infotainment:

- IntelliLink audio system
 - 7-inch colour touchscreen
 - AM/FM/DAB digital radio
 - Bluetooth® audio streaming
 - Bluetooth® mobile phone portal
 - Apple CarPlay™ / Android Auto™
 - USB audio connection

Interior convenience / styling:

- Air conditioning
- Cruise control
- Leather-covered steering wheel
- Steering wheel audio / phone / cruise controls
- Multi-function trip computer

Exterior convenience / styling:

- 17-inch black alloy wheels
- Black Jack roof and door mirrors
- Gloss black front grille bar
- Range of brilliant, metallic and premium colours available at no cost
- Sports suspension
- Electrically operated front windows
- Electrically adjustable / heated door mirrors

Safety / security features:

- Electronic Stability Programme (ESP)
- Anti-lock Braking System (ABS)
- Tyre pressure monitoring system
- Six airbags
- Daytime running lights
- Remote control central deadlocking



S OTR £18,875

Standard features include:

Infotainment:

- CD 30 BT audio system
 - AM/FM/DAB digital radio
 - CD/MP3 CD player
 - Bluetooth® audio streaming
 - Bluetooth® mobile phone portal
 - USB audio connection
 - Aux-in socket

Interior convenience / styling:

- Electronic climate control
- Cruise control
- Leather-covered steering wheel
- Steering wheel audio / phone / cruise controls
- Multi-function trip computer

Exterior convenience / styling:

- 18-inch diamond-cut alloy wheels
- Uprated brakes with red brake calipers
- Air intakes in front lower bumper
- Body-colour front lower spoiler, side sills and rear lower skirt
- Unique rear roof spoiler
- Black Jack roof and door mirrors
- Roof and door mirrors in a range of colours available at no cost
- Dark-tinted rear windows
- Sports suspension
- Electrically adjustable / heated door mirrors
- Chrome-effect upper side window mouldings
- Chrome-effect door sill covers

Safety / security features:

- Switchable Electronic Stability Programme (ESP)
- Anti-lock Braking System (ABS)
- Tyre pressure monitoring system
- Six airbags
- LED daytime running lights
- Remote control central deadlocking







ADAM JAM

3-door hatchback
OTR RRP CO₂ (g/km)

ADAM JAM – ON-THE-ROAD PRICES

Petrol	1.2i (70PS)	£13,450	128
--------	-------------	---------	-----

Please note: On-the-road recommended retail prices (RRP) include VAT at 20%, number plates and delivery to Retailer of £700.00 (inc. £116.67 VAT), 12 months' Vehicle Excise Duty and new vehicle first registration fee of £55.00. Excludes fuel and insurance.

KEY OPTIONS		Total inc. VAT
	Looking good: Brilliant paint	£285
	Metallic paint	£565
	Premium paint	£655
	Style Pack – Black Jack or White my Fire Roof Colour Pack / 17-inch alloy wheels / dark-tinted rear windows	£705
	Easier parking: Rear parking sensors	£285
	Driving assistance: Navi 4.0 IntelliLink navigation system	£785
	Sight and Light Pack One – Automatic lights / wipers / anti-dazzle rear-view mirror	£240
	Warm welcome: Winter Pack – Heated front seats / steering wheel	£225
	Practicality: Steel emergency spare wheel (in lieu of emergency tyre inflation kit)	£110

For details of these and other options please see Features / Options pages.



FEATURES

Infotainment:

- CD 30 BT audio system
 - AM/FM radio
 - CD/MP3 CD player
 - Bluetooth® audio streaming
 - Bluetooth® mobile phone portal
 - USB audio connection
 - Aux-in socket
- Four speakers

Interior convenience / styling:

- Cruise control
- Air conditioning
- Leather-covered steering wheel
- Speed-sensitive power-assisted steering
- City mode button
- Steering column adjustable for reach / rake
- Steering wheel audio / phone / cruise controls
- Driver's seat height adjuster
- Multi-function trip computer
- 50/50 split-folding rear seat back



Exterior convenience / styling:

- Electrically operated front windows
- Electrically adjustable / heated door mirrors
- Body-colour door handles
- Black B-pillars
- 16-inch alloy wheels

Safety / security features:

- Electronic Stability Programme (ESP)
- Anti-lock Braking System (ABS)
- Six airbags
- Hill start assist
- Seatbelt reminders for all seats
- ISOFIX child seat mounting points on rear seats
- Tyre pressure monitoring system
- Daytime running lights
- Remote control central locking
- Engine deadlock immobiliser

COMPANY CAR INFORMATION

-  P11D price starting at £13,230
-  From 26% tax band*
-  From £58 monthly BiK tax*
-  CO₂ emissions from 128g/km

Please see www.vauxhall.co.uk/fleet for details.

* = 2018/19 tax year.

ADAM ENERGISED

3-door hatchback
OTR RRP CO₂ (g/km)

ADAM ENERGISED – ON-THE-ROAD PRICES

Petrol 1.2i (70PS)	£15,295	128
--------------------	---------	-----

Please note: On-the-road recommended retail prices (RRP) include VAT at 20%, number plates and delivery to Retailer of £700.00 (inc. £116.67 VAT), 12 months' Vehicle Excise Duty and new vehicle first registration fee of £55.00. Excludes fuel and insurance.

KEY OPTIONS		Total inc. VAT
 Looking good:	Brilliant paint	No-cost
	Metallic paint	No-cost
	Premium paint	No-cost
	Dark-tinted rear windows	£175

For details of these and other options please see Features / Options pages.



FEATURES

Infotainment:

- IntelliLink audio system
 - 7-inch colour touchscreen
 - AM/FM/DAB digital radio
 - Bluetooth® audio streaming
 - Bluetooth® mobile phone portal
 - Apple CarPlay™ / Android Auto™
 - USB audio connection
- Four speakers

Interior convenience / styling:

- Air conditioning
- Leather-covered steering wheel
- Cruise control
- Speed-sensitive power-assisted steering
- City mode button
- Steering column adjustable for reach / rake
- Steering wheel audio / phone / cruise controls
- Driver's seat height adjuster
- Multi-function trip computer
- 50/50 split-folding rear seat





Exterior convenience / styling:

- Black Jack roof and door mirrors
- Gloss black front grille bar
- Range of brilliant, metallic and premium colours available at no cost
- Electrically operated front windows
- Electrically adjustable / heated door mirrors
- Sports suspension
- 17-inch black alloy wheels

Safety / security features:

- Electronic Stability Programme (ESP)
- Anti-lock Braking System (ABS)
- Six airbags
- Hill start assist
- Seatbelt reminders for all seats
- ISOFIX child seat mounting points on rear seats
- Tyre pressure monitoring system
- Daytime running lights
- Remote control central locking

COMPANY CAR INFORMATION

-  P11D price starting at £15,075
-  From 26% tax band*
-  From £66 monthly BiK tax*
-  CO₂ emissions from 128g/km

Please see www.vauxhall.co.uk/fleet for details.

* = 2018/19 tax year.





ADAM S

3-door hatchback
OTR RRP CO₂ (g/km)

ADAM S – ON-THE-ROAD PRICES

Petrol 1.4i Turbo (150PS) Start/Stop **£18,875** 145

Please note: On-the-road recommended retail prices (RRP) include VAT at 20%, number plates and delivery to Retailer of £700.00 (inc. £116.67 VAT), 12 months' Vehicle Excise Duty and new vehicle first registration fee of £55.00. Excludes fuel and insurance.

KEY OPTIONS		Total inc. VAT
 Looking good:	Brilliant paint	£285
	Metallic paint	£565
	Premium paint	£655
	Roof Colour Packs in a choice of colours	No-cost
	Black Jack bonnet	£100
 Easier parking:	Rear parking sensors	£285
 Driving assistance:	Navi 4.0 IntelliLink navigation system	£785
 Sitting comfortably:	Recaro sports front seats – Black Nappa leather seat facings / heated front seats / heated steering wheel	£2300
	Winter Pack – Heated front seats / steering wheel	£225

For details of these and other options please see Features / Options pages.



FEATURES

Infotainment:

- CD 30 BT audio system
 - AM/FM/DAB digital radio
 - CD/MP3 CD player
 - Bluetooth® audio streaming
 - Bluetooth® mobile phone portal
 - USB audio connection
 - Aux-in socket
- Six speakers

Interior convenience / styling:

- Electronic climate control
- Cruise control
- Leather-covered steering wheel
- Sports pedals
- Steering column adjustable for reach / rake
- Steering wheel audio / phone / cruise controls
- Driver's seat height adjuster
- Multi-function trip computer
- 50/50 split-folding rear seat



Exterior convenience / styling:

- Black Jack roof and door mirrors
- Uprated brakes with red brake calipers
- Body-colour front lower spoiler, side sills and rear lower skirt
- Unique rear roof spoiler
- Air intakes in front lower bumper
- Dark-tinted rear windows
- Sports suspension
- Electrically adjustable / heated door mirrors
- Black B-pillars
- 18-inch diamond-cut alloy wheels

Safety / security features:

- Switchable Electronic Stability Programme (ESP)
- Anti-lock Braking System (ABS)
- Six airbags
- Hill start assist
- ISOFIX child seat mounting points on rear seats
- Tyre pressure monitoring system
- LED daytime running lights
- Remote control central locking
- Engine deadlock immobiliser

COMPANY CAR INFORMATION

-  P11D price starting at £18,615
-  From 30% tax band*
-  From £94 monthly BiK tax*
-  CO₂ emissions from 145g/km

Please see www.vauxhall.co.uk/fleet for details.

* = 2018/19 tax year.

ADAM PRICES

Model 3-door hatch	Price (£)	VAT (£)	Total (£)	On-the-road RRP (£)	CO ₂ (g/km)
ADAM JAM					
1.2i (70PS)	10441.67	2088.33	12530.00	13450.00	128
ADAM ENERGISED (SPECIAL EDITION MODEL)					
1.2i (70PS)	11979.17	2395.83	14375.00	15295.00	128
ADAM S					
1.4i Turbo (150PS) Start/Stop	14929.17	2985.83	17915.00	18875.00	145

Please note: On-the-road recommended retail prices (RRP) include number plates and delivery to Retailer of £700.00 (inc. £116.67 VAT), 12 months' Vehicle Excise Duty and new vehicle first registration fee of £55.00. Excludes fuel and insurance.

ADAM FEATURES / OPTIONS

SAFETY

Driver/passenger airbags

- Driver's airbag • Front passenger's airbag • Front seat side-impact airbags
- Full-size curtain airbags for front and rear seat passengers

Seating

- Height-adjustable front seat head restraints • Outer rear seat head restraints
- Anti-submarining ramps in front seats – Helps prevent occupants sliding underneath the lap belt during a collision.

Seatbelts

- Height-adjustable front seatbelts • Four inertia-reel lap and diagonal seatbelts • Front seatbelt pretensioner system – Pretensioners tighten the seatbelt in the event of an accident limiting forward movement. • Front seatbelt force limiters – Reduces potential upper body injuries during a frontal impact. • Front and rear 'seatbelt unfastened' warning light

Child safety

- Deactivation switch for front passenger's front and side-impact airbags – Permits the safe use of a child seat in the front passenger seat. • ISOFIX child seat mountings incorporating top tether anchor points located on rear seats (does not include child seat) – Allows ISOFIX child safety seats to be securely fixed into the car. The ISOFIX mounting system reduces forward movement in an accident and makes the child seat easier to install.

Driver/passenger safety

- Energy-absorbing steering column • Pedal release system – Reduces potential injury to the driver's legs and feet during a severe frontal impact. • Laminated windscreen • Side-impact protection beams • Reinforced passenger safety cell • Deformation zones front and rear

Pedestrian safety

- Bonnet/headlight/wiper structure – Designed to reduce pedestrian head and upper body injuries.
- Upper and lower bumper design – Reduces upper and lower leg injuries.

Stability

Electronic Stability Programme (ESP):

– Works in conjunction with the vehicle's electronic braking and engine systems to keep the car stable in many different situations. ESP monitors many different inputs to determine when the car starts to lose traction, it can then immediately respond by varying the brake pressure between up to three wheels and adjust the engine output to help correct the loss of traction and improve stability.

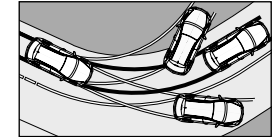

Additional ESP features:

- Traction control • Cornering brake control
- Straight line stability control

Braking

Anti-lock Braking System (ABS):

– Prevents the vehicle's wheels from locking up under heavy braking by momentarily reducing brake pressure at the appropriate wheel, ensuring that you can maintain control of the steering.

Additional braking features:

– The same electronic systems used in the ABS and ESP also deliver exceptional braking performance.

- Emergency brake assist – When emergency braking is detected the vehicle automatically applies the maximum possible braking assistance.
- Electronic brakeforce distribution – Automatically apportions the optimum braking force to each wheel. • Adaptive brake lights – Automatically warns other road users of heavy braking. • Hill start assist – Briefly maintains rear brake pressure to stop the vehicle rolling back on an incline. • Hazard warning lights

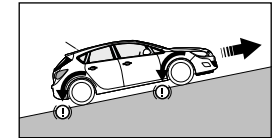

Tyre pressure

- Tyre pressure monitoring system

	JAM	ENERGISED	S	Price (£) exc. VAT	Total (£) inc. VAT
Additional feature			●		
• Switchable Electronic Stability Programme					

● = Standard equipment.

ADAM FEATURES / OPTIONS

	JAM	ENERGISED	S	Price (£) exc. VAT	Total (£) inc. VAT
DRIVER ASSISTANCE					
Cruise control with speed limiter <i>Cruise control feature – enables you to maintain a constant speed – making it ideal for economical motorway driving.</i> <ul style="list-style-type: none"> The speed limiter function – can be set to ensure that you do not exceed the speed limit and can be easily overridden if required. Steering wheel mounted controls 	●	●	●		
Parking sensors <ul style="list-style-type: none"> Rear parking distance sensors – audible warning.  Easier parking	○		○	237.50	285.00
Technical Pack <ul style="list-style-type: none"> Rear parking distance sensors • R4.0 IntelliLink – see infotainment section for details. 	○		○	500.00	600.00
Steering <ul style="list-style-type: none"> Speed-sensitive electric power-assisted steering 	●	●	●		
<ul style="list-style-type: none"> City mode button – Provides lighter steering at parking speeds 	●	●			
SECURITY					
Standard security features <ul style="list-style-type: none"> 'Key left in ignition' audible warning • Electronically protected audio equipment • Engine deadlock immobiliser Visible Vehicle Identification Number (VIN) • Locking wheel bolts for alloy wheels 	●	●	●		
Central locking <ul style="list-style-type: none"> Remote control • Operates on doors, tailgate and fuel filler flap • Deadlocking • Central locking activation switch on fascia One folding key/one static key each with integral remote control function (folding key is colour-keyed to body colour on ADAM JAM and ENERGISED models) 	●	●	●		

● = Standard equipment. ○ = Optional at extra cost.

ADAM FEATURES / OPTIONS

DRIVER INFORMATION	JAM	ENERGISED	S	Price (£) exc. VAT	Total (£) inc. VAT
Instrumentation <ul style="list-style-type: none"> • Black instruments with chrome edging • Speedometer • Rev counter • Fuel gauge with low fuel level warning light • Water temperature gauge • Instrument panel light dimmer • Shift-up indication light (Start/Stop models) – <i>Indicates when to change gear for optimum fuel economy</i> 	●	●	●		
Driver information display (centrally located in instrument cluster) <ul style="list-style-type: none"> • Displays trip computer data • Total mileage • Service-due indicator • Tyre pressure monitoring system • Handbrake-on / low brake fluid level warning lights 	●	●	●		
Central facia display (format dependent on infotainment unit) <ul style="list-style-type: none"> • Audio information • Digital clock with automatic RDS time adjustment • Outside air temperature with ice warning function • Additional features dependent on infotainment unit (see infotainment for details) 	●	●	●		
Multi-function trip computer (displayed on driver information display) <ul style="list-style-type: none"> • Trip mileage • Vehicle range based on remaining fuel • Average fuel economy • Instantaneous fuel economy 	●	●	●		

● = Standard equipment.

ADAM FEATURES / OPTIONS

INTERIOR STYLING	JAM	ENERGISED	S	Price (£) exc. VAT	Total (£) inc. VAT
JAM interior décor Steering wheel: • Three-spoke design • Leather-covered • Satin chrome-effect bezel Facia and door trim: • Japan Black facia and door panel inserts (Black Jack, Orange Alert and Pump up the Blue models) • Pearl White facia and door panel inserts (Saturday White Fever and Shades of Grey models) • Facia and door panel inserts matched to exterior colour (all other models) • Black door panels with black Atlantis cloth inserts • Chrome-effect interior door handles Seat trim: • Imix black fabric seat trim inserts • Plain black fabric side bolsters and surrounds	●				
ENERGISED interior décor Steering wheel: • Three-spoke design • Leather-covered • Satin chrome-effect bezel Facia and door trim: • Japan Black facia and door panel inserts (Orange Alert, White My Fire and Shades of Grey models) • Facia and door panel inserts matched to exterior colour (all other models) • Black door panels with black leather-effect inserts • Chrome-effect interior door handles Seat trim: • Ocio black fabric seat trim inserts • Black leather-effect side bolsters and surrounds Pedals: • Sports, alloy-effect		●			
S interior décor Steering wheel: • VX-Line three-spoke design • Leather-covered flat bottom • Satin chrome-effect bezel Gear knob: • VX-Line leather-covered Facia and door trim: • Red your Engine facia and door panel inserts • Black door panels with black leather-effect inserts • Chrome-effect interior door handles Seat trim: • Red your Engine black fabric seat trim inserts • Black leather-effect side bolsters and surrounds with accent stitching Pedals: • Sports, alloy-effect Door sill covers: • Chrome-effect			●		
Japan Black facia and door panel inserts			N/C		No-cost option

● = Standard equipment. N/C = No-cost option.

ADAM FEATURES / OPTIONS

INFOTAINMENT	JAM	ENERGISED	S	Price (£) exc. VAT	Total (£) inc. VAT
CD 30 BT Onboard features: • CD/MP3 CD player • AM/FM stereo radio with 36 station presets • RDS with Traffic Programme Media connections: • USB connection with iPod control • Aux-in socket Mobile phone portal: • Bluetooth® connectivity • Handsfree calls via steering wheel controls • Vehicle microphone • Phone book access	●		●		
R4.0 IntelliLink touchscreen infotainment system <i>For use with media players, USB memory sticks, mobile phones and smartphone apps.</i> Onboard features: • 7-inch colour touchscreen • AM/FM stereo radio with 36 station presets • RDS with Traffic Programme Media connections: • USB connection with iPod control • Bluetooth® A2DP audio streaming (Advanced Audio Distribution Profile) Mobile phone portal: • Bluetooth® connectivity • Handsfree calls via steering wheel controls • Vehicle microphone • Phone book access – <i>The majority of the phone's functions – contacts/last calls/missed calls etc. – are mirrored on IntelliLink's display and are easily navigated using the touchscreen (features dependent on mobile phone).</i> Smartphone interface: • Apple CarPlay™ • Android Auto™ – <i>Smartphone projection that allows operations via voice command, touchscreen and buttons to control apps and music playback</i> Gallery – only available when the vehicle is stationary: • Photo gallery with slide show feature • Video playback with soundtrack played through car speakers	□	●	□		

● = Standard equipment. □ = Available as part of an extra-cost option pack.

ADAM FEATURES / OPTIONS





INFOTAINMENT

	JAM	ENERGISED	S	Price (£) exc. VAT	Total (£) inc. VAT
Navi 4.0 IntelliLink touchscreen navigation and infotainment system (not available in conjunction with Technical Pack) <i>For use with media players, USB memory sticks, mobile phones and smartphone apps.</i> Onboard features: • 7-inch colour touchscreen • AM/FM stereo radio with 36 station presets • RDS with Traffic Programme Navigation features: • Satellite navigation system • 2D street level mapping • European coverage • Structured or one-box destination entry • Points-of-interest search • Eco routing • Map updates via USB Media connections: • USB connection with iPod control • Bluetooth® A2DP audio streaming (Advanced Audio Distribution Profile) Mobile phone portal: • Bluetooth® connectivity • Handsfree calls via steering wheel controls • Vehicle microphone • Phone book access – <i>The majority of the phone's functions – contacts/last calls/missed calls etc. – are mirrored on IntelliLink's display and are easily navigated using the touchscreen (features dependent on mobile phone).</i> Smartphone interface: • Apple CarPlay™ • Android Auto™ – <i>Smartphone projection that allows operations via voice command, touchscreen and buttons to control apps and music playback.</i> Gallery – only available when the vehicle is stationary: • Photo gallery with slide show feature • Video playback with soundtrack played through car speakers	○		○	654.17	785.00
Digital radio		●	●		
Number of speakers	4*	4	6		
Steering wheel mounted audio controls	●	●	●		

● = Standard equipment. ○ = Optional at extra cost.

* = 6 speakers are fitted when optional Technical Pack or rear parking distance sensors are specified.

ADAM FEATURES / OPTIONS

	JAM	ENERGISED	S	Price (£) exc. VAT	Total (£) inc. VAT
HEATING AND VENTILATION					
Air conditioning • Air recirculation facility • Cabin particulate filter – <i>Removes dust, airborne particles and pollen</i> • Four-speed fan • Illuminated controls	●	●			
Electronic climate control incorporating air conditioning • Single-zone control • Advanced predictive logic control system using sun sensor • Cabin charcoal filter – <i>Removes dust, airborne particles, pollen and unpleasant odours</i> • Automatic air direction and fan speed with manual override • LCD temperature display • Six-speed fan • Illuminated controls  Set and forget temperature control			●		
Winter Pack (fitted at no extra cost in conjunction with optional leather seat facings) • Heated leather-covered steering wheel • Heated front seats  Warm welcome  	○		○	187.50	225.00
Additional features • Four adjustable facia vents • Windscreen demist vents • Side window demist vents • Heated rear screen with timed cut-off	●	●	●		
SEATING AND COMFORT					
Reach and rake adjustable steering	●	●	●		
Comfort front seats Driver's seat (eight-way adjustable): • Height (up/down) • Reach (fore/aft) • Backrest (upright/recline) • Head restraint (up/down) Front passenger's seat (six-way adjustable): • Reach (fore/aft) • Backrest (upright/recline) • Head restraint (up/down)	●	●	●		
Recaro sports front seats in black premium Nappa leather Driver's and front passenger's seat (six-way adjustable): • Height (up/down) • Reach (fore/aft) • Backrest (upright/recline)			○	1916.67	2300.00
Easy-entry front seats with memory function	●	●	●		
Rear seats • Two-person layout • 50/50 split-folding rear seat back • Removable head restraints • ISOFIX child seat mountings incorporating top tether anchor points located on rear seats (does not include child seat) – <i>Allows ISOFIX child safety seats to be securely fixed into the car. The ISOFIX mounting system reduces forward movement in an accident and makes the child seat easier to install.</i>	●	●	●		

● = Standard equipment. ○ = Optional at extra cost.

ADAM FEATURES / OPTIONS

INTERIOR CONVENIENCE	JAM	ENERGISED	S	Price (£) exc. VAT	Total (£) inc. VAT
Convenience features • Front 12-volt electrical accessory socket • Driver's and front passengers sunvisors • Driver's vanity mirror with cover • Dipping rear-view mirror • Driver's and front passenger's tiltable assist handles	●	●	●		
Automatically dimming anti-dazzle rear-view mirror	□		□		
Velour floor mats			●		
Interior lighting • Central front courtesy light • Fade up/fade down • Front map reading lights	●	●	●		
Interior storage • Storage box on driver's side lower fascia • Glovebox with lid • Front door pockets • Two drinks holders in rear of centre console • Rear stowage compartments in side panel	●	●	●		
• Storage pockets on front seat backs			●		
• Drinks holder in front centre console with adjustable restraining strap			●		
Luggage area • Luggage compartment cover • Illuminated, carpeted, luggage area • Interior tailgate handles • Load restraint lashing eyes • Twin gas-assisted tailgate struts	●	●	●		

MECHANICAL

Standard features • Front-wheel drive • Gas-pressure dampers • Front anti-roll bar • Speed-sensitive electric power-assisted steering	●	●	●		
• Sports suspension – fitted to JAM models in conjunction with optional 17-inch wheels. Not available separately.	○	●	●		

● = Standard equipment. ○ = Optional at extra cost. □ = Available as part of an extra-cost option pack.

ADAM FEATURES / OPTIONS

	JAM	ENERGISED	S	Price (£) exc. VAT	Total (£) inc. VAT
EXTERIOR LIGHTING					
Standard lighting features • Halogen headlights • Welcome lighting • Lights-on audible warning • Electric headlight beam levelling • High-level LED centre rear brake light • Rear fog light	●	●	●		
Daytime running lights	●	●			
LED daytime running lights			●		
Sight and Light Pack • Rain-sensitive windscreen wipers • Automatic lighting control with tunnel detection • Automatically dimming anti-dazzle rear-view mirror	○		○	200.00	240.00

EXTERIOR CONVENIENCE

Windscreen wipers • Two-speed windscreen wipers with variable intermittent wipe • Intermittent rear window wash/wipe • Rain-sensitive windscreen wipers – <i>Fitted in conjunction with Sight and Light Pack. Not available separately.</i>	● □	● □	● □		
Door mirrors • Electrically adjustable/heated door mirrors (wide-angle on driver's side), manually foldable	●	●	●		
Windows • Electrically operated front windows with safety autoreverse and one-touch facility • Heated rear window with automatic timed cut-off	●	●	●		

● = Standard equipment. ○ = Optional at extra cost. □ = Available as part of an extra-cost option pack.

ADAM FEATURES / OPTIONS

	JAM	ENERGISED	S	Price (£) exc. VAT	Total (£) inc. VAT
EXTERIOR STYLING					
Body-colour door handles	●	●	●		
Body-colour roof and door mirrors	●		N/C	No-cost option	
Roof Colour Packs <i>The roof and door mirrors are available in a range of colours</i>					
• Black Jack	□	●	●	254.17	305.00
• White my Fire	□		N/C	254.17	305.00
• Red 'n' Roll			N/C	No-cost option	
Style Pack • Choice of Black Jack or White my Fire Roof Colour Pack • 17-inch Swiss Blade Silver alloy wheels • Dark-tinted rear windows	○			587.50	705.00
Chrome-effect upper side window mouldings			●		
Chrome-effect front grille bar	●		●		
High-gloss black front grille bar		●			
Black B-pillars	●	●	●		
Rear roof spoiler			●		
Chrome-effect exhaust tailpipe extension			●		
Windows					
• Tinted windows	●	●	●		
• Dark-tinted rear windows (also available as part of optional Style Pack)	○	○	●	145.83	175.00

● = Standard equipment. ○ = Optional at extra cost. N/C = No-cost option. □ = Available as part of an extra-cost option pack.

ADAM FEATURES / OPTIONS

EXTERIOR COLOURS		JAM	ENERGISED	S	Price (£) exc. VAT	Total (£) inc. VAT
	Orange Alert • Solid paint	●	N/C			
	Red 'n' Roll • Brilliant paint	○	●	●	237.50	285.00
	Saturday White Fever • Brilliant paint	○	N/C	○	237.50	285.00
	White my Fire • Brilliant paint		N/C		237.50	285.00

● = Standard equipment. ○ = Optional at extra cost. N/C = No-cost option.

The colours reproduced may vary slightly from the actual paint colour. As a result they should be used as a guide only. Your Vauxhall Retailer has a comprehensive display of our paint samples.





ADAM FEATURES / OPTIONS

EXTERIOR COLOURS		JAM	ENERGISED	S	Price (£) exc. VAT	Total (£) inc. VAT
	Black Jack • Two-coat metallic paint	<input type="radio"/>	N/C	<input type="radio"/>	470.83	565.00
	Shades of Grey • Two-coat metallic paint	<input type="radio"/>	N/C	<input type="radio"/>	470.83	565.00
	Let it Blue • Two-coat premium paint		N/C	<input type="radio"/>	545.83	655.00
	Pump up the Blue • Two-coat premium paint	<input type="radio"/>		<input type="radio"/>	545.83	655.00

○ = Optional at extra cost. N/C = No-cost option.



The colours reproduced may vary slightly from the actual paint colour. As a result they should be used as a guide only. Your Vauxhall Retailer has a comprehensive display of our paint samples.

ADAM FEATURES / OPTIONS

WHEELS AND TYRES		JAM	ENERGISED	S	Price (£) exc. VAT	Total (£) inc. VAT
Emergency spare wheel (in lieu of emergency tyre inflation kit)		○			91.67	110.00
	16-inch Horns Silver alloy wheels • 195/55 R 16 tyres • Emergency tyre inflation kit (in lieu of spare wheel)	●				
	17-inch Gloss Black Hurricane alloy wheels • 215/45 R 17 tyres • Emergency tyre inflation kit (in lieu of spare wheel)		●			
	17-inch Swiss Blade Silver alloy wheels • 215/45 R 17 tyres • Emergency tyre inflation kit (in lieu of spare wheel)	□				
	18-inch Technical Grey Propellor diamond-cut alloy wheels • 225/35 R 18 tyres • Emergency tyre inflation kit (in lieu of spare wheel)			●		

● = Standard equipment. ○ = Optional at extra cost. □ = Available as part of an extra-cost option pack.

TYRE RATING

Tyre size	Fuel efficiency group	Wet grip performance	External noise	
			Measured (dB)	Group
195/55 R 16	B-C	B	71	
215/45 R 17	C	B	71	
225/35 R 18	C	B	77	

Tyre rating according to EU Regulation 1222/2009

ADAM SPECIFICATIONS

PETROL ENGINES

	1.2i (70PS)	1.4i Turbo (150PS) with Start/Stop
Capacity	1229cc	1364cc
Maximum power	70PS (51kW) @ 5600rpm	150PS (110kW) @ 4900-5500rpm
Maximum torque	115Nm (85 lb.ft.) @ 4000rpm	220Nm (162 lb.ft.) @ 2750-4500rpm
Configuration	4 cylinders, 4 valves per cylinder, double overhead camshafts	4 cylinders, 4 valves per cylinder, double overhead camshafts
Fuel/induction system	Naturally aspirated. Variable Valve Timing. Multi-point sequential fuel injection	Water-cooled turbocharger with intercooler. Variable Valve Timing (VVT) Multi-point sequential fuel injection
Emission compliance	Euro 6d-TEMP (6.2)	Euro 6d-TEMP (6.2)
Service interval	20,000 miles or 1 year (whichever occurs sooner)	20,000 miles or 1 year (whichever occurs sooner)

PERFORMANCE, FUEL ECONOMY AND EMISSIONS

	Wheel size (inches)	Performance (manufacturer's figures)		Fuel economy mpg (litres/100km)#			CO ₂ emissions g/km#	Vehicle Excise Duty*		Benefit in kind company car taxation rates – 2018/19 tax year
		Maximum speed (mph)	Acceleration 0-62mph (sec)	Urban driving	Extra-urban driving	Combined figure		First year rate	Standard rate	
Manual										
1.2i (70PS)	16/17	103	14.9	38.7 (7.3)	61.4 (4.6)	50.4 (5.6)	128	£165	£140	26%
1.4i Turbo (150PS) Start/Stop	18	130	8.5	34.4 (8.2)	53.3 (5.3)	44.1 (6.4)	145	£205	£140	30%

* = Correct at time of publication.

= Fuel consumption data and CO₂ emission data are determined using the Worldwide harmonized Light vehicles Test Procedure (WLTP), and the relevant values are translated back to allow the comparability into NEDC, according to regulations R (EC) No. 715/2007, R (EU) No. 2017/1153 and R (EU) No. 2017/1151. The values do not take into account in particular use and driving conditions, equipment or options and may vary depending on the format of tyres. For more information on official fuel consumption and CO₂ emission values, please read the guidelines at <http://carfueldata.dft.gov.uk/> and for more information on WLTP please see www.vauxhall.co.uk/wltp

ADAM SPECIFICATIONS

START/STOP TECHNOLOGY

The ADAM Start/Stop system offers real benefits by improving fuel economy and reducing CO₂ emissions, particularly in town. It does this by automatically stopping the engine when you come to a standstill, and then restarting as you prepare to move off.

Before automatically stopping the engine a number of system checks are carried out to ensure that it is both safe and practical to do so. To ensure safety, the driver must depress the clutch pedal, shift in to neutral, and then release the clutch pedal.

System checks carried out before Auto Stop activates include:

- Start/Stop system is not manually deactivated via the facia button
- Sufficient brake vacuum is available to prevent the car rolling down an incline
- Battery is in good condition and charged
- Outside air temperature and engine temperature are above specified minima
- Electronic climate control (where fitted) is not in maximum heating or maximum cooling mode

If all of these conditions are satisfied then the vehicle will Auto Stop.

When you are ready to pull away from standstill, Auto Restart is activated by depressing the clutch pedal.

Whilst at a standstill the vehicle is continually monitored. If necessary, the engine will automatically be restarted. Conditions that would initiate an Auto Restart include:

- Low battery level
- Cabin temperature is too high
- Driver's seatbelt unfastened or driver's door opened
- Bonnet is released or opened

TRANSMISSION

Five-speed manual gearbox:

Standard on all models (except 1.4i Turbo (150PS)).

Six-speed manual gearbox:

Standard on 1.4i Turbo (150PS) models only.

STEERING

- Speed-sensitive power-assisted steering

SUSPENSION

Front: Independent. MacPherson struts with gas-pressure dampers and coil springs. Anti-roll bar.

Rear: Compound crank with coil springs and gas-pressure dampers.

BRAKING AND STABILITY

- Electronic Stability Programme – switchable on ADAM S models
- Cornering brake control
- Straight line stability control
- Anti-lock Braking System (ABS)
- Electronic brakeforce distribution
- Emergency brake assist
- Dual circuit, diagonally split braking system
- ADAM S models feature red calipers

1.2i (70PS)

Front ventilated discs: 257mm diameter

Rear drums: 203mm diameter

1.4i Turbo (150PS)

Front ventilated discs: 308mm diameter

Rear discs: 264mm diameter

FUEL TANK CAPACITY

- 38 litres (8.4 gallons)

GROSS VEHICLE WEIGHTS kg

1.2i (70PS)	1470
1.4i Turbo (150PS)	1565

Gross vehicle weight is the total permissible weight of the vehicle including passengers and luggage. The maximum roof rack loading should not exceed 50kg.

INSURANCE GROUPS

1.2i (70PS)	3E
1.4i Turbo (150PS)	15E

ADAM SPECIFICATIONS

EXTERIOR DIMENSIONS millimetres (inches)

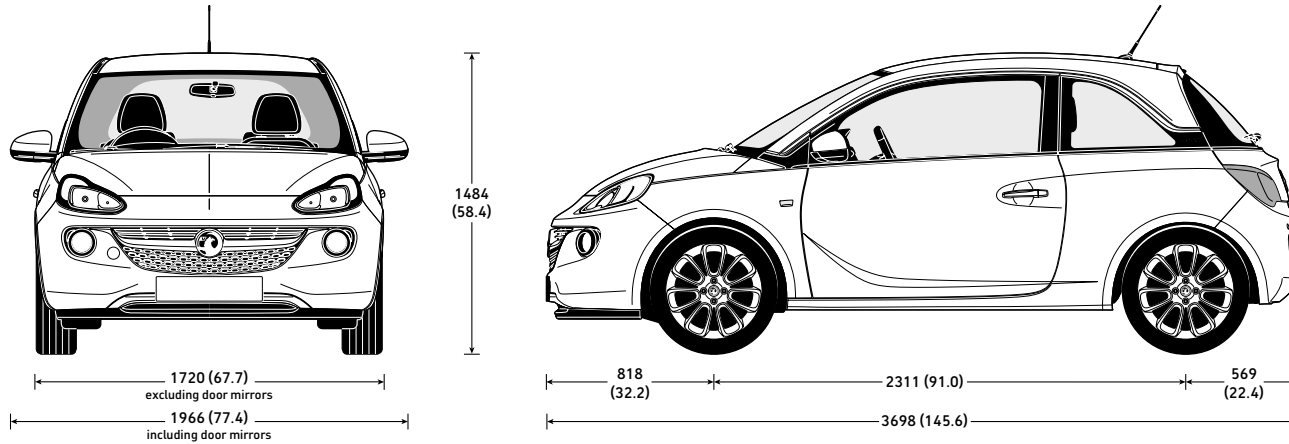

LOADSPACE DIMENSIONS mm (inches)

Maximum length (behind rear seats)	462 (18.2)
Maximum length (rear seats folded)	1041 (41.0)
Maximum width	963 (37.9)
Width between wheel arches	954 (37.6)
Maximum height	874 (34.4)

LOADSPACE CAPACITIES* litres (cu.ft.)

Rear seats up (under luggage compartment cover)	170 (6.0)
Rear seats folded (to upper edge of front seat back)	484 (17.1)
Rear seats folded (to roof)	663 (23.4)

* = Measured using the ECIE method.

ADAM ACCESSORIES

	Total (inc. VAT)
CHILD SEATS¹	
BABY-SAFE ² – 0-13kg/birth to 15 months	£135.00
– ISOFIX base	£234.00
DUO ISOFIX ² – 9-18kg/9 months to 4 years	
with top tether kit	£358.00
KID2 –15-36kg or 4 to 12 years	£162.00

1 = Restrictions apply to the use of child seats, please consult your Vauxhall Retailer or request a copy of the Child seats brochure.

2 = Without transponder.

FLEXCONNECT RANGE

FlexConnect bracket	£21.00
FlexConnect hook	£31.00
FlexConnect coat hanger	£33.00
FlexConnect folding table	£74.00
FlexConnect iPad Mini cradle	£105.00
FlexConnect iPad (1-4) cradle	£113.00
FlexConnect iPad Air cradle	£112.00
FlexConnect Samsung Galaxy cradle	£102.00

INTERIOR

Velour floor mats (set of four)	from £56.00
Rubber floor mats (set of four)	£47.00
Rear view mirror cap (fitted)	from £56.00
Front console mat	£40.00
Centre console armrest (fitted)	£119.00
Cargo box with lid	£187.00
Coloured leather gear knob and gaiter (fitted)	from £63.00
Stainless steel pedal covers – manual (fitted)	£158.00

EXTERIOR STYLING³

VX-Line body styling – front lower spoiler/side sills/rear lower skirts (painted/fitted)	£1591.00
VX-Line body styling – rear roof spoiler (painted/fitted)	£550.00

3 = Not available on S models.

Please note:

Prices shown are fully fitted and painted, where applicable and include VAT. Please check with your local Vauxhall Retailer for details. It is advisable to ensure your insurance policy is adequate to cover additional fitted accessories. Prices correct at time of publication.

	Total (inc. VAT)
EXTERIOR	
Door mirror caps (fitted)	from £112.00
Painted radiator grille (fitted)	from £106.00
'Fly' decals	
– B-pillar decal (fitted)	£62.00
– C-pillar decal (fitted)	£164.00

'Splat' graphics	
Front wing/rear quarter decals (fitted)	from £150.00
'Sport 01' graphics	
– Bonnet decal (fitted)	£80.00
– Roof decal (fitted)	£100.00
– C-pillar decal (fitted)	£74.00
'Stripes' graphics	
– Bonnet decal (fitted)	from £153.00
– Roof decal (fitted)	from £149.00
– Door decals (fitted)	from £133.00
– Door / door mirror decals (fitted)	from £133.00
'Stars and Stripes' graphics	
– Roof / B Pillar decals (fitted)	£197.00
'Chequered' graphics	
– Roof decal (fitted)	£123.00
'Motorsport' graphics	
– Bonnet / body side decals (fitted)	£401.00
Body side protection mouldings (painted/fitted)	£225.00

PROTECTION

Tyre sealant – 450ml	£75.00
Tyre repair kit	£113.00
Safety pack – first aid kit/hi-visibility vest/warning triangle	£36.00
First aid kit	£15.00
Hi-visibility vest	£9.00
Warning triangle	£17.00
Spare bulb kit	£27.00
Protection film – front bumper (fitted)	£171.00
Protection film – rear bumper (fitted)	£41.00
Privacy shades – tailgate/rear side windows	£188.00
Exterior windscreen cover	£47.00
Outdoor car cover	£99.00
Mudflaps – front (fitted)	£66.00
Mudflaps – rear (fitted)	£58.00

	Total (inc. VAT)
TRANSPORT SYSTEMS	
Roof base carrier	£145.00
Roof carriers (requires base carrier)	
Bike roof carrier – Thule Freeride 532	£76.00
Surf board roof carrier – Thule 833	£80.00
Kayak roof carrier – Thule 837	£168.00

Ski roof carrier (400mm wide) – Thule Deluxe 726	£141.00
Ski roof carrier (600mm wide) – Thule 739	£205.00

Hard shell roof boxes (requires base carrier)

Thule Ocean 80 (320 litre / 1330 x 860 x 370mm)	£150.00
Thule Ocean 200 (390 litre / 1750 x 820 x 450mm)	£316.00
Thule Dynamic 800 (320 litre / 2060 x 840 x 340mm)	£625.00
Thule Dynamic 900 (430 litre / 2350 x 940 x 350mm)	£750.00
Thule Excellence (520 litre / 2180 x 940 x 400mm)	£898.00
Thule Motion 800 (460 litre / 2050 x 840 x 450mm)	from £452.00
Thule Touring 200 (400 litre / 1750 x 820 x 450mm)	£330.00
Thule Touring 780 (430 litre / 2320 x 700 x 420mm)	£370.00
Soft roof boxes (requires base carrier)	
Thule Ranger 90 (280 litre / 1100 x 800 x 400mm)	£285.00
Thule Ranger 500 (300 litre / 1900 x 500 x 300mm)	£378.00

	Total (inc. VAT)
ALLOY WHEELS (set of four with centre caps)⁴	

16-inch Horns	
– Silver	£1200.00
– Black	£1194.00
16-inch Vintage	£1200.00
16-inch Boomerang	
– Grey / diamond cut face	£1194.00
– Green / diamond cut face	£1194.00
– White / diamond cut face	£1194.00
16-inch Triple Cross	
– Titan grey	£1200.00
– Manoogian	£1194.00
18-inch Turbine	£1712.00
17-inch Hurricane	
– Manoogian	£1362.00
– Black	£1362.00
– White	£1194.00
17-inch Swiss Blade	
– Silver	£1214.00
– Black / white rim	£1382.00
– Black / red rim	£1382.00
– Black / blue rim	£1382.00
17-inch Roulette	
– Grey	£1194.00
– Grey / diamond cut face	£1362.00
– Grey / white face	£1362.00
– Grey / brown face	£1362.00
– Grey / green face	£1362.00
– Copper / white face	£1362.00
– Copper / diamond cut face	£1362.00
– Black gloss	£1362.00
18-inch Twister	
– Grey	£1938.00
– Manoogian	£1938.00
Coloured wheel clips for Twister wheels (set of four)	from £52.00
Tyre valve caps with Vauxhall logos – set of four	£23.00

4 = Different tyres and locking wheel bolts/nuts may be required at extra cost. Price excludes new tyres and locking wheel bolts/nuts, includes static wheel balancing.

ADAM COMPANY CAR DRIVER/FLEET INFORMATION



COMPANY CAR DRIVER FREE 3 DAY TEST DRIVE

Our free* 3 Day Test Drive programme is open to all Company Car Drivers. It allows you to choose most models in the current Vauxhall line-up (exclusions apply). With full insurance cover provided, it gives you a meaningful length of time to make an informed decision about your next company car.

Click below to book your free* test drive
www.vauxhall3dtd.co.uk
or call 0330 587 8221**

*The free 3 Day Test Drive programme is open to Company Car Drivers and Fleet Decision Makers. Available for UK Mainland only. Terms and conditions apply. Full terms and conditions can be found at vauxhallfleet.co.uk/testdrive/index/terms. **Telephone lines open Monday-Friday 9.00am to 5.00pm excluding Bank Holidays. Calls may be recorded or monitored for quality and/or training purposes.

FLEET TOOLBOX

Discover the facts in our online Toolbox for both Company Car Drivers and Fleet Decision Makers. The Fleet Toolbox has a host of useful calculators, comparators, interactive listings and information. Visit the Fleet Toolbox by going to www.vauxhall-toolbox.co.uk



ROADTRIP APP

The Vauxhall RoadTrip App is a free app that calculates and logs your mileage expenses for any UK business trips and generates reports to help you complete your mileage claims. Available for both iPhone and Android, visit www.vauxhall-toolbox.co.uk or visit the iPhone or Android stores and search for Vauxhall RoadTrip to download it to your smartphone or tablet.



BENEFIT IN KIND COMPANY CAR TAXATION†

The car benefit charge will be the car's list price (including VAT, options and accessories fitted, delivery to Retailer and number plates, but excluding Vehicle Excise Duty and new vehicle first registration fee) multiplied by the percentage charge for the CO₂ emissions band in which the car falls (see table opposite). Multiply this figure by your personal income tax rate (20%†† for Basic Rate, 40%†† for Higher Rate) to calculate your annual benefit in kind tax liability.

Example:

ADAM JAM 1.2i (70PS)
(CO₂ emissions 128g/km)

On-the-road RRP	£13450.00
Deduct: Vehicle Excise Duty	(£165.00)
New vehicle first registration fee	(£55.00)
Effective list price	£13230.00
Add: Optional two-coat metallic paint	£565.00

List price for tax purposes (P11D value)
£13795.00

Car benefit charge
2018-19 tax year (26%) £3586.00

Benefit in kind tax liability (2018-19 tax year)	
Basic Rate (20%) tax payer	£717.20
Higher Rate (40%) tax payer	£1434.40

† = Please note this Price Guide provides taxation information as a guide only. Vauxhall does not provide taxation guidance. Drivers should always take professional advice on their own tax position. †† = Excludes residents of Scotland.

BIK FOR SCOTTISH RESIDENTS

Effective 6 April 2018 the Scottish Government have introduced their own BIK taxation structure. This only applies to Company Car Drivers that are Scottish taxpayers. HMRC will determine whether or not an individual is a Scottish taxpayer based on where their main place of residence is.

The BIK rates for Scotland are:

- Over £11,850-£13,850 Starter Rate 19%
- Over £13,850-£24,000 Basic Rate 20%
- Over £24,000-£43,430 Intermediate Rate 21%
- Over £43,430-£150,000 Higher Rate 41%
- Above £150,000 Top Rate 46%

CO ₂ emissions in grams per kilometre	Percentage of car's price to be taxed	
	Non-Diesel† 2018-19 tax year	Diesel†† 2018-19 tax year
Up to 50	13	17
51-75	16	20
76-94	19	23
95-99	20	24
100-104	21	25
105-109	22	26
110-114	23	27
115-119	24	28
120-124	25	29
125-129	26	30
130-134	27	31
135-139	28	32
140-144	29	33
145-149	30	34
150-154	31	35
155-159	32	36
160-164	33	37
165-169	34	37
170-174	35	37
175-179	36	37
180 and above	37	37

† = Also applies to diesel vehicles that meet the Real Driving Emissions Step 2 (RDE2). †† = Applies to vehicles that do not meet the Real Driving Emissions Step 2 (RDE2).

To calculate your own personal liability a car tax calculator is available at:
<https://www.vauxhallfleet.co.uk/toolbox>

CONTACT VAUXHALL FLEET

Please contact one of our dedicated sales teams who will be happy to help with your particular enquiry.

Company Car Drivers

Call: 0345 111 2020

Email: company-car@vauxhallinfo.co.uk

Telephone lines are open

– Monday to Friday 8.00am-9.00pm

– Saturday and Sunday 9.00am-6.00pm

Fleet Decision Makers

Depending on the size of your fleet of vehicles, we have a dedicated team to handle your enquiries. The lines are open Monday to Friday excluding Bank Holidays.

1-24 vehicles

Call: 0845 076 2254 (8.30am-5.00pm)

Email: b2bsales@vauxhall.co.uk

25+ vehicles

Call: 0330 587 8222 (8.30am-5.00pm)

Email: vauxhallfleet@vauxhall.co.uk

Special Vehicles (Police, Fire and Ambulance)

Call: 01582 409999 (8.30am-5.00pm)

Email: vauxhallspecialvehicles@vauxhall.co.uk

ADAM ADDITIONAL INFORMATION

ON-THE-ROAD PRICES

To eliminate uncertainty about hidden costs when buying a new car, Vauxhall publishes on-the-road recommended retail prices (RRP) and these are shown in the pricing tables within this price guide. These prices include VAT, number plates and delivery to Retailer of £700.00 (including £116.67 VAT), 12 months' Government Vehicle Excise Duty (see opposite for details) and the DVLA new vehicle first registration fee of £55.00*.

Please note: The on-the-road recommended retail price (RRP) does not include fuel supplied by the Retailer, motor insurance or any other goods or services supplied by agreement between the Retailer and the customer.

PRICE PROTECTION

Order a new Vauxhall for build in the current model year (as confirmed by your Retailer) for delivery no more than three months in advance and the price you are quoted is the price you pay. This is irrespective of any subsequent price rises between placing your order and delivery of your new car, but you must take delivery as soon as the car is available. Vauxhall Motors Limited is not liable for price adjustments caused by Government changes in the rate of VAT (currently 20%), Vehicle Excise Duty, DVLA new vehicle first registration fee or by any other applicable legislation or regulations.

VAUXHALL FINANCE LEASING

Vauxhall Finance Leasing is a trading style of Vauxhall Finance plc. Working with the Vauxhall Retailer network we provide competitive car and van leasing solutions for business users and private individuals. We combine the support of a national contract with the convenience of a local contact. For further information, please contact your local Vauxhall Retailer or visit www.vauxhall.co.uk/leasing

IN THE EVENT OF AN ACCIDENT...

Vauxhall Accident Management helps keep you mobile following an accident. Benefits include vehicle recovery, Vauxhall-approved repairs and contacting your insurer. For more details, visit vauxhall.co.uk/AccidentManagement

VEHICLE EXCISE DUTY

The amount of Vehicle Excise Duty (road fund licence) payable on new cars varies depending on the level of carbon dioxide (CO₂) emissions produced by the vehicle. CO₂ emissions are measured in grammes (g) per kilometre (km) travelled and divided into 13 charging bands shown in the table below.

A 'first year rate' of Vehicle Excise Duty is payable on all new cars and in subsequent years the amount payable reverts to the 'standard rate'. From 1 April 2017 the breakpoints for each of these bands have been revised. Also, for vehicles with a list price over £40,000, including factory-fitted options, an additional £310 is payable for the first five years of standard rate payments.

VEHICLE EXCISE DUTY*

	CO ₂ emissions	First year rate		Standard rate
		Non-diesel**	Diesel†	
Band A	0g/km	£0.00	£0.00	£0.00
Band B	1 – 50g/km	£10.00	£25.00	£140.00
Band C	51 – 75g/km	£25.00	£105.00	£140.00
Band D	76 – 90g/km	£105.00	£125.00	£140.00
Band E	91 – 100g/km	£125.00	£145.00	£140.00
Band F	101 – 110g/km	£145.00	£165.00	£140.00
Band G	111 – 130g/km	£165.00	£205.00	£140.00
Band H	131 – 150g/km	£205.00	£515.00	£140.00
Band I	151 – 170g/km	£515.00	£830.00	£140.00
Band J	171 – 190g/km	£830.00	£1,240.00	£140.00
Band K	191 – 225g/km	£1,240.00	£1,760.00	£140.00
Band L	226 – 255g/km	£1,760.00	£2,070.00	£140.00
Band M	over 255g/km	£2,070.00	£2,070.00	£140.00

* = Correct at time of issue. ** = Also applies to diesel vehicles that meet the Real Driving Emissions Step 2 (RDE2).

† = Applies to vehicles that do not meet the Real Driving Emissions Step 2 (RDE2).

TRUST VAUXHALL

CUSTOMER CARE COMMITMENT

For added peace of mind, Vauxhall has an innovative Customer Care Commitment that offers the following:

- Three-year vehicle warranty consisting of a one-year/unlimited mileage manufacturer's warranty and a second and third year manufacturer's warranty with a 60,000 miles limitation
- Vauxhall Assistance for 12 months from first registration
- Six years' body panel anti-perforation warranty

Please note: Warranty is only available on vehicles sourced from Vauxhall Motors Limited. Terms and conditions apply – please see your Vauxhall Retailer for details.

VAUXHALL ASSISTANCE

Vauxhall Assistance is provided automatically with every new Vauxhall for 12 months from first registration and covers everything from accident assistance, roadside recovery and 'at home' service to flat tyres. With Vauxhall Assistance help is literally just a free* phone call away, 24 hours a day, 365 days a year!

* = Mobile phone users will be charged at their standard tariff.

PROTECTING THE ENVIRONMENT

Vauxhall's commitment to the environment is demonstrated by our products' many environmental awards. For even more information on Vauxhall's efforts to achieve an environmentally sustainable future, and how to dispose of your end-of-life vehicle, see www.vauxhall.co.uk/recycling

VAUXHALL SERVICE PLAN

- Fixed monthly payments for the plan duration
- Easy to budget and interest-free
- Genuine parts fitted by Vauxhall-trained technicians

Plus on Gold plans:

- Valet and courtesy car
- Full AA cover
- Engine flush and fuel treatments
- Litre of oil for top ups between services

Full details can be obtained from your local participating Vauxhall Retailer.

VAUXHALL INSURANCE WITH ADDED REASSURANCE

Comprehensive cover – Summary of benefits**

- Competitive premiums
- Repairs by a Vauxhall-trained technician
- Genuine Vauxhall parts, guaranteed for three years when we repair your car within our Approved Repairer Network
- Free courtesy car as standard when using an Approved Repairer†
- 24 hour claims helpline
- Personal Accident benefit
- Cover for audio equipment
- Windscreen cover

Call for a quote on 0844 463 2670††

** = The benefits listed above are for comprehensive cover only. For details of Third Party, Fire and Theft cover, please call our sales team.
† = Should your car need repairing following an accident we provide a courtesy car (subject to availability) for the duration of the repair. Only genuine Vauxhall parts are used. Terms and conditions apply.
†† = Calls may be recorded. Vauxhall Insurance is underwritten by Ageas Insurance Limited.

FOR MORE PRODUCT INFORMATION

For a brochure on any Vauxhall model (up to a maximum of three per caller) or location of your nearest Vauxhall Retailer please call **0345 600 1500**. Alternatively, details can be found on our website at www.vauxhall.co.uk

JOIN US ONLINE:



Privacy Policy – For full details please visit: vauxhall.co.uk/privacy

The invoice price, including delivery to Retailer, factory-fitted options, accessories fitted by the Retailer and number plates, is subject to VAT. Some feature descriptions in this guide may refer to, and some illustrations may show, optional equipment not included in the standard delivery. The information contained in this guide was accurate at the time of publication. We reserve the right to make changes in design and equipment. Please note that Vauxhall Retailers are not the agents of Vauxhall Motors Limited and are not authorised to bind Vauxhall Motors Limited by any specific or implied undertaking or representation. It is advisable to ensure that your motor insurance policy provides adequate cover for additional fitted options and accessories. The colours in this guide are only approximate actual colours. Illustrated optional equipment is available at extra charge. Availability, technical features and equipment provided on our vehicles can vary by model. For precise information on the equipment provided on our vehicles, please contact your local Vauxhall Retailer.

VAUXHALL

vauxhall.co.uk

©2018 Vauxhall Motors Limited

Published 20 November 2018 Vauxhall Motors Limited