

Manufacturer's recommended retail prices for Vauxhall cars and accessories

Car and Accessory Price Guide

Effective from 3 February 2009 Edition 1



Pricing information

On-the-road prices

To eliminate uncertainty about hidden costs when buying a new car, Vauxhall publishes on-the-road recommended retail prices (RRP) and these are shown in the pricing tables within this price guide. These prices include the recommended cost of number plates and delivery to a Vauxhall retailer of £615.00 (including £80.22 VAT), 12 months' Government Vehicle Excise Duty (see opposite for details) and the DVLA new vehicle first registration fee of £55.00*.

* = Correct at time of going to press.

Please note: The on-the-road recommended retail price (RRP) does not include fuel supplied by the retailer, motor insurance or any other goods or services supplied by agreement between the retailer and the customer.

Price protection

Order a new Vauxhall for build in the current model year (as confirmed by your retailer) for delivery no more than three months in advance and the price you are quoted is the price you pay. This is irrespective of any subsequent price rises between placing your order and delivery of your new car, but you must take delivery as soon as the car is available. General Motors UK Limited is not liable for price adjustments caused by Government changes in the rate of VAT (currently 15%), Vehicle Excise Duty, DVLA new vehicle first registration fee or by any other applicable legislation or regulations.

Benefit in kind company car taxation**

The car benefit charge will be the car's list price (including VAT, options and accessories fitted, delivery to retailer and number plates, but excluding Vehicle Excise Duty and new vehicle first registration fee) multiplied by the percentage charge for the CO₂ emissions band in which the car falls (see table opposite). Multiply this figure by your personal income tax rate (20% for Basic Rate, 40% for Higher Rate for 2008-09 tax year) to calculate your annual benefit in kind tax liability.

Example:

Astra Life 1.6i 16v manual 5-door hatchback (CO ₂ emissions 155g/km)	
On-the-road RRP	£14820.00
Deduct: Vehicle Excise Duty	(£145.00)
New vehicle first registration fee	(£55.00)
Effective list price	£14620.00
Add: Optional two-coat metallic paint	£395.00
List price for tax purposes (P11D value)	£15015.00
Car benefit charge	
2008-09/2009-10 tax years (19%)	£2853.00
Benefit in kind tax liability (2008-09/2009-10 tax years)	
Basic Rate (20%) tax payer	£571.00
Higher Rate (40%) tax payer	£1141.00

** = Please note this Price Guide provides taxation information as a guide only. Vauxhall does not purport to provide taxation guidance. Drivers should always take professional advice on their own tax position.

CO ₂ emissions in grams per kilometre	Percentage of car's price to be taxed	
	Petrol 2008-09/2009-10 tax years	Diesel 2008-09/2009-10 tax years
up to 120	10	13
121-139	15	18
140-144	16	19
145-149	17	20
150-154	18	21
155-159	19	22
160-164	20	23
165-169	21	24
170-174	22	25
175-179	23	26
180-184	24	27
185-189	25	28
190-194	26	29
195-199	27	30
200-204	28	31
205-209	29	32
210-214	30	33
215-219	31	34
220-224	32	35
225-229	33	35
230-234	34	35
235-239	35	35
240 and above	35	35

To calculate your own personal liability a car tax calculator is available on the Fleet section at www.vauxhall.co.uk

Vauxhall Internet Price (VIP)

All Vauxhall cars have a special Vauxhall internet price (VIP) as well as the on-the-road recommended retail price (RRP). See www.vauxhall.co.uk for details. It is Vauxhall's understanding that company car taxation will continue to be based on the on-the-road recommended retail price (RRP).

Vehicle Excise Duty

The amount of Vehicle Excise Duty (road fund licence) payable on new cars varies depending on the level of carbon dioxide (CO₂) emissions produced by the vehicle. CO₂ emissions are measured in grammes (g) per kilometre (km) travelled and divided into seven charging bands shown in the table below.

Vehicle Excise Duty*

	CO ₂ emissions	Petrol/Diesel
Band A	up to 100g/km	£0.00
Band B	101-120g/km	£35.00
Band C	121-150g/km	£120.00
Band D	151-165g/km	£145.00
Band E	166-185g/km	£170.00
Band F	186-225g/km	£210.00
Band G	over 225g/km	£400.00

* = Correct at time of going to press.

Protecting the environment

Vauxhall has always been at the forefront of environmental issues and our products are increasingly winning green automotive awards.

However, our commitment to preserving the environment goes even further. We have reduced manufacturing emissions and our new vehicles use more recycled materials in their construction and more recyclable parts than ever before.

Looking further into the future we are working on cleaner, alternative power sources, including zero-emission fuel cell technology.

For more information

For information on Vauxhall's efforts to achieve an environmentally sustainable future, including information on Design for Recycling, take-back of End-of-Life Vehicles (ELVs), and the recycling of ELVs, see www.vauxhall.co.uk/recycling.

Recycling Allowance

Further proof of our long-term commitment to the environment comes in the form of our Recycling Allowance programme. Buy a selected low-emission Vauxhall model and we'll offer you £1000 (£500 on Agila)[†] to take your old, higher emission car off the road.

Should you want a car that's not included in the Recycling Allowance programme, we can still help you dispose of your old car. Our partners Autogreen Ltd offer free and easily accessible, environmentally friendly, end-of-life vehicle disposal.

[†] = Applies to selected Agila, Corsa, Meriva, Astra and Zafira models only. Please see your retailer for further details.

Vauxhall supporting



Smarter driving tips

- Drive at an appropriate speed: – Staying within the speed limit increases driver safety, reduces CO₂ emissions and saves fuel. At 70mph you could be using up to 9% more fuel than at 60mph and up to 15% more fuel than at 50mph
- Drive smoothly at all times: – Anticipate the ebb and flow of the traffic to avoid harsh acceleration and braking
- Reduce your revs: – Change gear earlier to help reduce fuel consumption – try 2500rpm with petrol engines and 2000rpm with diesel
- Idling is wasting fuel: – If you're likely to be at a standstill for more than three minutes, switch off the engine to save fuel
- Regularly check your tyre pressures: – Under inflated tyres increase CO₂ emissions whilst incorrectly inflated tyres can be unsafe. Always check your handbook for the correct tyre pressure. This will also help to increase the life of your tyres
- Remove unnecessary items from the car: – Extra weight increases the engine's workload, whilst roof racks and bike carriers increase wind resistance. All burn more fuel and increase CO₂ emissions



Customer information	2
Agila	4
Tigra	6
Corsa	8
Meriva	12
Astra Sport Hatch	14
Astra hatchback	16
Astra estate	20
Astra TwinTop	22
Zafira	24
Insignia	28
Vectra	36
Antara	38
VXR	39
Fuel consumption figures	45
Vivaro Combi	48
Movano Combi	49
Options explained	50
Accessories	54
Customer care	58



5-door MPC

Model	Price (£)	VAT (£)	Total (£)	On-the-road RRP (£)	CO ₂ * (g/km)
Agila Expression					
1.0i 12v ecoFLEX	6278.26	941.74	7220.00	7925.00	120
Agila Club					
1.0i 12v ecoFLEX	7243.48	1086.52	8330.00	9035.00	120
1.2i 16v	7513.04	1126.96	8640.00	9430.00	131
1.2i 16v auto	8360.87	1254.13	9615.00	10405.00	142
1.0i 12v ecoFLEX (a/c)	7669.57	1150.43	8820.00	9525.00	120
1.2i 16v (a/c)	7939.13	1190.87	9130.00	9920.00	131
1.2i 16v auto (a/c)	8786.96	1318.04	10105.00	10895.00	142
Diesel					
1.3CDTi 16v ecoFLEX	8943.48	1341.52	10285.00	10990.00	120
1.3CDTi 16v ecoFLEX (a/c)	9369.57	1405.43	10775.00	11480.00	120

Model	Price (£)	VAT (£)	Total (£)	On-the-road RRP (£)	CO ₂ * (g/km)
Agila Design					
1.2i 16v (a/c)	8108.70	1216.30	9325.00	10115.00	131
1.2i 16v auto (a/c)	8956.52	1343.48	10300.00	11090.00	142
Diesel					
1.3CDTi 16v ecoFLEX (a/c)	9539.13	1430.87	10970.00	11675.00	120

Please note: On-the-road recommended retail prices (RRP) include number plates and delivery to retailer of £615.00 (inc. £80.22 VAT), 12 months' Vehicle Excise Duty (see page 2) and new vehicle first registration fee of £55.00. Excludes fuel and insurance.

* = CO₂ emission figures. Vehicle Excise Duty is based on CO₂ emissions (see page 2 for details).

For benefit in kind taxation charges see page 2.

a/c = Air conditioning.



See pages 54-57 for accessory and styling products



See page 45 for fuel data



See page 59 for MasterFit Service Plan details

Option availability

	Expression	Club	Design	Price (£) exc. VAT	Total (£) inc. VAT
Safety option					
Electronic Stability Programme (ESP)	<input type="radio"/>	<input type="radio"/>	<input type="radio"/>	386.96	445.00
Exterior option					
Two-coat metallic or pearlescent paint	<input type="radio"/>	<input type="radio"/>	<input type="radio"/>	343.48	395.00

○ = Optional at extra cost.

Accessory highlights

	Price (£) exc. VAT	Total (£) inc. VAT
Agila accessories		
Safety Pack • First aid kit • Warning triangle • Hi-visibility vest	21.28	24.47
Protection Pack • Velour mats (four) • Mudflaps (four) • Cargo liner	123.40	141.91

For further details of accessories and styling products see pages 54-57.

2-door coupé roadster

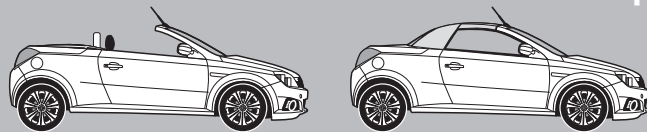

Model	Price (£)	VAT (£)	Total (£)	On-the-road RRP (£)	CO ₂ * (g/km)
Tigra Air					
1.4i 16v	12343.48	1851.52	14195.00	14985.00	146
1.4i 16v Easytronic	12921.74	1938.26	14860.00	15650.00	144
1.4i 16v (a/c)	12769.57	1915.43	14685.00	15475.00	146
1.4i 16v Easytronic (a/c)	13347.83	2002.17	15350.00	16140.00	144
Diesel					
1.3CDTi 16v	13230.43	1984.57	15215.00	16005.00	124
1.3CDTi 16v (a/c)	13656.52	2048.48	15705.00	16495.00	124
Tigra Sport Rouge					
1.4i 16v	13378.26	2006.74	15385.00	16175.00	146
1.8i 16v	14043.48	2106.52	16150.00	16990.00	179
1.4i 16v (a/c)	13804.35	2070.65	15875.00	16665.00	146
1.8i 16v (a/c)	14469.57	2170.43	16640.00	17480.00	179
Diesel					
1.3CDTi 16v	14265.22	2139.78	16405.00	17195.00	124
1.3CDTi 16v (a/c)	14691.30	2203.70	16895.00	17685.00	124

Model	Price (£)	VAT (£)	Total (£)	On-the-road RRP (£)	CO ₂ * (g/km)
Tigra Exclusiv					
1.4i 16v (a/c)	13391.30	2008.70	15400.00	16190.00	146
1.4i 16v Easytronic (a/c)	13969.57	2095.43	16065.00	16855.00	144
1.8i 16v (a/c)	14056.52	2108.48	16165.00	17005.00	179
Diesel					
1.3CDTi 16v (a/c)	14278.26	2141.74	16420.00	17210.00	124

Please note: On-the-road recommended retail prices (RRP) include number plates and delivery to retailer of £615.00 (inc. £80.22 VAT), 12 months' Vehicle Excise Duty (see page 2) and new vehicle first registration fee of £55.00. Excludes fuel and insurance.

* = CO₂ emission figures. Vehicle Excise Duty is based on CO₂ emissions (see page 2 for details).
For benefit in kind taxation charges see page 2.
a/c = Air conditioning.



See pages 54-57 for accessory and styling products



See page 45 for fuel data



See page 59 for MasterFit Service Plan details

Accessory highlights

Tigra accessories

	Price (£) exc. VAT	Total (£) inc. VAT
Safety Pack • First aid kit • Warning triangle • Hi-visibility vest	21.28	24.47
Protection Pack • Velour mats • Windbreak	169.36	194.77

For further details of accessories and styling products see pages 54-57.

Option availability

	Air	Sport Rouge	Exclusiv	Price (£) exc. VAT	Total (£) inc. VAT
Option packs					
VXR Styling Pack One • Body-colour front lower spoiler/rear lower skirt/boot lip spoiler and side sills	○	○	○	695.65	800.00
Leather Pack • Leather seat facings • Electrically heated sports seats	○	○	●	600.00	690.00
Travel Pack • Windbreak • Retaining net for storage area behind seats	○	●	●	130.43	150.00
Plus Pack ¹ • Cruise control • Driver information centre including trip computer	○	○	○	256.52	295.00
Safety options					
Electronic Stability Programme (ESP) ⓘ see page 53	○	○	○	386.96	445.00
Automatic seat occupancy detection for passenger's airbags	○	○	○	108.70	125.00
Exterior options					
17-inch five-spoke alloy wheels with 205/45 R 17 tyres ²	○	○	● ³	321.74	370.00
Rear parking distance sensor ⓘ see page 51	○	○	○	321.74	370.00
Targa roof bar in body colour	●	○	○ ⁴	86.96	100.00
Two-coat metallic or pearlescent paint	○	○	○	343.48	395.00
Audio and communication options					
CD 30 MP3 • CD player with MP3 format • Stereo radio • Auxiliary-in socket ⓘ see page 51	○	●	●	86.96	100.00
CD 70 • Satellite navigation system • CD player with MP3 format • Stereo radio • Auxiliary-in socket • Graphic display ⓘ see page 50	○	○	○	830.43	955.00

○ = Optional at extra cost. ● = Standard equipment.

¹ = Not available on 1.3CDTi 16v models. ² = The steel spare wheel is replaced by an emergency tyre inflation kit to effect a temporary 'get you home' repair. ³ = Exclusiv models feature 17-inch five-spoke alloy wheels with anthracite inner.

⁴ = Standard on models with optional Star Silver two-coat metallic paint.

3-door hatchback

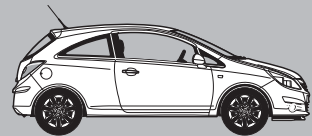

Model	Price (£)	VAT (£)	Total (£)	On-the-road RRP (£)	CO ₂ * (g/km)
Corsa Expression					
1.0i 12v	6665.22	999.78	7665.00	8455.00	134
Corsa Life					
1.0i 12v	7634.78	1145.22	8780.00	9570.00	134
1.2i 16v	7973.91	1196.09	9170.00	9960.00	139
1.2i 16v Easytronic	8400.00	1260.00	9660.00	10450.00	137
1.0i 12v (a/c)	8060.87	1209.13	9270.00	10060.00	134
1.2i 16v (a/c)	8400.00	1260.00	9660.00	10450.00	139
1.2i 16v Easytronic (a/c)	8826.09	1323.91	10150.00	10940.00	137
Diesel					
1.3CDTi 16v (75PS) ecoFLEX (a/c)	8817.39	1322.61	10140.00	10845.00	119
1.3CDTi 16v (75PS) ecoFLEX (a/c)	9243.48	1386.52	10630.00	11335.00	119
Corsa Active (Special Edition model)					
1.0i 12v (a/c)	8243.48	1236.52	9480.00	10270.00	134
1.2i 16v (a/c)	8582.61	1287.39	9870.00	10660.00	139
1.2i 16v Easytronic (a/c)	9008.70	1351.30	10360.00	11150.00	137
Diesel					
1.3CDTi 16v (75PS) ecoFLEX (a/c)	9426.09	1413.91	10840.00	11545.00	119
Corsa Active Plus (Special Edition model)					
1.0i 12v (a/c)	8669.57	1300.43	9970.00	10760.00	134
1.2i 16v (a/c)	9008.70	1351.30	10360.00	11150.00	139
1.2i 16v Easytronic (a/c)	9434.78	1415.22	10850.00	11640.00	137
Diesel					
1.3CDTi 16v (75PS) ecoFLEX (a/c)	9852.17	1477.83	11330.00	12035.00	119
Corsa Club					
1.2i 16v	8404.35	1260.65	9665.00	10455.00	139
1.2i 16v Easytronic	8830.43	1324.57	10155.00	10945.00	137
1.4i 16v	8830.43	1324.57	10155.00	10945.00	146
1.4i 16v auto	9660.87	1449.13	11110.00	11925.00	154
1.2i 16v (a/c)	8830.43	1324.57	10155.00	10945.00	139
1.2i 16v Easytronic (a/c)	9256.52	1388.48	10645.00	11435.00	137
1.4i 16v (a/c)	9256.52	1388.48	10645.00	11435.00	146
1.4i 16v auto (a/c)	10086.96	1513.04	11600.00	12415.00	154
Diesel					
1.3CDTi 16v (75PS) ecoFLEX	9247.83	1387.17	10635.00	11340.00	119
1.3CDTi 16v (75PS) ecoFLEX (a/c)	9673.91	1451.09	11125.00	11830.00	119

Model	Price (£)	VAT (£)	Total (£)	On-the-road RRP (£)	CO ₂ * (g/km)
Corsa Design					
1.2i 16v (a/c)	9765.22	1464.78	11230.00	12020.00	139
1.4i 16v (a/c)	10186.96	1528.04	11715.00	12505.00	146
1.4i 16v auto (a/c)	11017.39	1652.61	12670.00	13485.00	154
Diesel					
1.3CDTi 16v (75PS) ecoFLEX (a/c)	10604.35	1590.65	12195.00	12900.00	119
1.3CDTi 16v (90PS) (a/c)	10860.87	1629.13	12490.00	13280.00	127
1.7CDTi 16v (a/c)	11756.52	1763.48	13520.00	14310.00	130
Corsa Design inTouch**					
1.2i 16v (a/c)	10813.04	1621.96	12435.00	13225.00	139
Corsa SXi					
1.2i 16v	9156.52	1373.48	10530.00	11320.00	146
1.4i 16v	9578.26	1436.74	11015.00	11805.00	146
1.4i 16v auto	10408.70	1561.30	11970.00	12785.00	154
1.2i 16v (a/c)	9582.61	1437.39	11020.00	11810.00	146
1.4i 16v (a/c)	10004.35	1500.65	11505.00	12295.00	146
1.4i 16v auto (a/c)	10834.78	1625.22	12460.00	13275.00	154
Diesel					
1.3CDTi 16v (75PS) ecoFLEX	9995.65	1499.35	11495.00	12200.00	119
1.3CDTi 16v (90PS)	10252.17	1537.83	11790.00	12580.00	127
1.3CDTi 16v (75PS) ecoFLEX (a/c)	10421.74	1563.26	11985.00	12690.00	119
1.3CDTi 16v (90PS) (a/c)	10678.26	1601.74	12280.00	13070.00	127
Corsa SXi inTouch**					
1.2i 16v (a/c)	10286.96	1543.04	11830.00	12620.00	146
Corsa SRI					
1.6i 16v Turbo (150PS)	11943.48	1791.52	13735.00	14615.00	189
1.6i 16v Turbo (150PS) (a/c)	12369.57	1855.43	14225.00	15105.00	189
Diesel					
1.7CDTi 16v (a/c)	12965.22	1944.78	14910.00	15700.00	130

Please note: On-the-road recommended retail prices (RRP) include number plates and delivery to retailer of £615.00 (inc. £80.22 VAT), 12 months' Vehicle Excise Duty (see page 2) and new vehicle first registration fee of £55.00. Excludes fuel and insurance.

* = CO₂ emission figures. Vehicle Excise Duty is based on CO₂ emissions (see page 2 for details). For benefit in kind taxation charges see page 2.

** = inTouch model features Pioneer AVIC-F900BT European DVD navigation unit. Two-coat metallic/pearlescent paint is the only option available on SXi inTouch, standard on Design inTouch. Please refer to the Corsa inTouch brochure for further details.
a/c = Air conditioning.

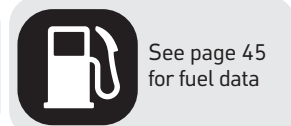
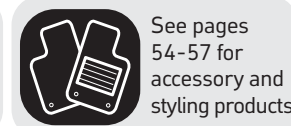
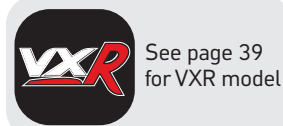

Option availability

	Expression	Life	Active	Active Plus	Club	Design	SXi	SRI	Price (£) exc. VAT	Total (£) inc. VAT
Option packs										
VXR Styling Pack One ¹ • Body-colour front lower spoiler/side sills/rear lower skirt/rear roof spoiler							○ ²	●	695.65	800.00
Sight and Light Pack • Rain-sensitive windscreen wipers • Electro-chromatic anti-dazzle rear-view mirror • Automatic lighting control						●	○	○	173.91	200.00
Protection Pack • Front seat side-impact airbags • Full-size curtain airbags • Pyrotechnic front lap belt pretensioner system	○	○	○	○	●	●	●	●	360.87	415.00
Winter Pack • Electrically heated front seats • Electrically heated leather-covered steering wheel					○	○	○ ³	○ ³	182.61	210.00
Plus Pack • Driver's seat height adjuster • Steering column adjustable for reach and rake		○			●	●	●	●	91.30	105.00
Plus Pack • 15-inch alloy wheels (steel spare) • Front fog lights • Cruise control • Multi-function trip computer					○				408.70	470.00
Plus Pack • Electronic Climate Control (ECC) incorporating air conditioning 1 see page 52 • Cruise control • Multi-function trip computer • Graphic information display						○	○ ⁴	○ ⁴	434.78	500.00
Safety options										
Electronic Stability Programme-plus (ESP-plus) with traction control 1 see page 53	○	○	○	○	○	○	○	●	386.96	445.00
ISOFIX child seat restraint system for front passenger's seat (does not include child seat)		○	○	○	○	○	○	○	91.30	105.00
Exterior and convenience options										
17-inch alloy wheels with 215/45 R 17 ultra-low profile tyres						○ ⁵	○ ⁵	●	269.57	310.00
Adaptive Forward Lighting (AFL) – halogen 1 see page 52						○	○	○	226.09	260.00
Electrically operated sliding glass sunroof with interior blind ⁶				●	○	○	○	○	495.65	570.00
Flex-Fix® integrated carrier system (includes two-bicycle carrier attachment) ⁷					○	○	○	○	369.57	425.00
Rear parking distance sensors ⁸ 1 see page 51					○	○	○	○	226.09	260.00
Two-coat metallic or pearlescent paint		○	○	○	○	○ ⁹	○	○	343.48	395.00
Audio and communication options										
CD 60 • Satellite navigation system • CD player with MP3 format • Stereo radio • Auxiliary-in socket • Graphic display					○	○	○	○	830.43	955.00
Mobile phone system with Bluetooth® (does not include phone or cradle) and graphic display – see page 57 for details of mobile phone compatibility 1 see page 50					○	○	○	○	256.52	295.00

○ = Optional at extra cost. ● = Standard equipment.

1 = Not available in conjunction with Flex-Fix® integrated carrier system. The spare wheel is replaced by an emergency tyre inflation kit. **2** = Not available on 1.3CDTi 16v (75PS) models. **3** = Deletes sports steering wheel. **4** = Only available on models fitted with air conditioning. **5** = Not available on 1.3CDTi 16v (75PS) models. Includes sports suspension with lower ride height and progressive-rate variable ratio power-assisted steering. **6** = Also includes front map reading lights and front passenger's seat height adjuster. Deletes front passenger's underseat storage tray. Roof panel is coloured black. **7** = Not available in conjunction with VXR Styling Pack One or rear parking distance sensors. The spare wheel is replaced by an emergency tyre inflation kit. **8** = Not available in conjunction with Flex-Fix® integrated carrier system. **9** = Standard on Design inTouch model only.

Accessory highlights

	Price (£) exc. VAT	Total (£) inc. VAT
Corsa accessories		
Safety Pack • First aid kit • Warning triangle • Hi-visibility vest	21.28	24.47
Protection Pack • Velour mats (four) • Mudflaps (four) • Cargo liner	135.32	155.62

For further details of accessories and styling products see pages 54-57.

5-door hatchback

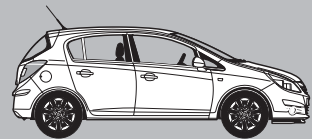

Model	Price (£)	VAT (£)	Total (£)	On-the-road RRP (£)	CO ₂ * (g/km)
Corsa Life					
1.0i 12v	8252.17	1237.83	9490.00	10280.00	134
1.2i 16v	8591.30	1288.70	9880.00	10670.00	139
1.2i 16v Easytronic	9017.39	1352.61	10370.00	11160.00	137
1.0i 12v (a/c)	8678.26	1301.74	9980.00	10770.00	134
1.2i 16v (a/c)	9017.39	1352.61	10370.00	11160.00	139
1.2i 16v Easytronic (a/c)	9443.48	1416.52	10860.00	11650.00	137
<i>Diesel</i>					
1.3CDTi 16v (75PS) ecoFLEX	9434.78	1415.22	10850.00	11555.00	119
1.3CDTi 16v (75PS) ecoFLEX (a/c)	9860.87	1479.13	11340.00	12045.00	119
Corsa Active (Special Edition model)					
1.0i 12v (a/c)	8860.87	1329.13	10190.00	10980.00	134
1.2i 16v (a/c)	9200.00	1380.00	10580.00	11370.00	139
1.2i 16v Easytronic (a/c)	9626.09	1443.91	11070.00	11860.00	137
<i>Diesel</i>					
1.3CDTi 16v (75PS) ecoFLEX (a/c)	10043.48	1506.52	11550.00	12255.00	119
Corsa Active Plus (Special Edition model)					
1.0i 12v (a/c)	9286.96	1393.04	10680.00	11470.00	134
1.2i 16v (a/c)	9626.09	1443.91	11070.00	11860.00	139
1.2i 16v Easytronic (a/c)	10052.17	1507.83	11560.00	12350.00	137
<i>Diesel</i>					
1.3CDTi 16v (75PS) ecoFLEX (a/c)	10469.57	1570.43	12040.00	12745.00	119
Corsa Club					
1.2i 16v	9021.74	1353.26	10375.00	11165.00	139
1.2i 16v Easytronic	9447.83	1417.17	10865.00	11655.00	137
1.4i 16v	9447.83	1417.17	10865.00	11655.00	146
1.4i 16v auto	10278.26	1541.74	11820.00	12635.00	158
1.2i 16v (a/c)	9447.83	1417.17	10865.00	11655.00	139
1.2i 16v Easytronic (a/c)	9873.91	1481.09	11355.00	12145.00	137
1.4i 16v (a/c)	9873.91	1481.09	11355.00	12145.00	146
1.4i 16v auto (a/c)	10704.35	1605.65	12310.00	13125.00	158
<i>Diesel</i>					
1.3CDTi 16v (75PS) ecoFLEX	9865.22	1479.78	11345.00	12050.00	119
1.3CDTi 16v (75PS) ecoFLEX (a/c)	10291.30	1543.70	11835.00	12540.00	119

Model	Price (£)	VAT (£)	Total (£)	On-the-road RRP (£)	CO ₂ * (g/km)
Corsa Design					
1.2i 16v (a/c)	10382.61	1557.39	11940.00	12730.00	139
1.4i 16v (a/c)	10804.35	1620.65	12425.00	13215.00	146
1.4i 16v auto (a/c)	11634.78	1745.22	13380.00	14195.00	158
<i>Diesel</i>					
1.3CDTi 16v (75PS) ecoFLEX (a/c)	11221.74	1683.26	12905.00	13610.00	119
1.3CDTi 16v (90PS) (a/c)	11478.26	1721.74	13200.00	13990.00	127
1.7CDTi 16v (a/c)	12373.91	1856.09	14230.00	15020.00	132
Corsa SXi					
1.2i 16v	9773.91	1466.09	11240.00	12030.00	146
1.4i 16v	10195.65	1529.35	11725.00	12515.00	146
1.4i 16v auto	11026.09	1653.91	12680.00	13495.00	158
1.2i 16v (a/c)	10200.00	1530.00	11730.00	12520.00	146
1.4i 16v (a/c)	10621.74	1593.26	12215.00	13005.00	146
1.4i 16v auto (a/c)	11452.17	1717.83	13170.00	13985.00	158
<i>Diesel</i>					
1.3CDTi 16v (75PS) ecoFLEX	10613.04	1591.96	12205.00	12910.00	119
1.3CDTi 16v (90PS)	10869.57	1630.43	12500.00	13290.00	127
1.3CDTi 16v (75PS) ecoFLEX (a/c)	11039.13	1655.87	12695.00	13400.00	119
1.3CDTi 16v (90PS) (a/c)	11295.65	1694.35	12990.00	13780.00	127
Corsa SXi inTouch**					
1.2i 16v (a/c)	10904.35	1635.65	12540.00	13330.00	146
Corsa SRI					
1.6i 16v Turbo (150PS)	12560.87	1884.13	14445.00	15325.00	189
1.6i 16v Turbo (150PS) (a/c)	12986.96	1948.04	14935.00	15815.00	189
<i>Diesel</i>					
1.7CDTi 16v (a/c)	13582.61	2037.39	15620.00	16410.00	132

Please note: On-the-road recommended retail prices (RRP) include number plates and delivery to retailer of £615.00 (inc. £80.22 VAT), 12 months' Vehicle Excise Duty (see page 2) and new vehicle first registration fee of £55.00. Excludes fuel and insurance.

* = CO₂ emission figures. Vehicle Excise Duty is based on CO₂ emissions (see page 2 for details). For benefit in kind taxation charges see page 2.

** = inTouch model features Pioneer AVIC-F900BT European DVD navigation unit. Two-coat metallic/pearlescent paint is the only option available. Please refer to the Corsa inTouch brochure for further details.

a/c = Air conditioning.



See pages 54-57 for accessory and styling products



See page 45 for fuel data



See page 59 for MasterFit Service Plan details

Option availability

	Life	Active	Active Plus	Club	Design	SXi	SRI	Price (£) exc. VAT	Total (£) inc. VAT
Option packs									
VXR Styling Pack One ¹ • Body-colour front lower spoiler/side sills/rear lower skirt/rear roof spoiler						○ ²	●	695.65	800.00
Sight and Light Pack • Rain-sensitive windscreen wipers • Electro-chromatic anti-dazzle rear-view mirror • Automatic lighting control					●	○	○	173.91	200.00
Protection Pack • Front seat side-impact airbags • Full-size curtain airbags • Pyrotechnic front lap belt pretensioner system	○	○	○	●	●	●	●	360.87	415.00
Winter Pack • Electrically heated front seats • Electrically heated leather-covered steering wheel				○	○	○ ³	○ ³	182.61	210.00
Plus Pack • Driver's seat height adjuster • Steering column adjustable for reach and rake	○			●	●	●	●	91.30	105.00
Plus Pack • 15-inch alloy wheels (steel spare) • Front fog lights • Cruise control • Multi-function trip computer				○				408.70	470.00
Plus Pack • Electronic Climate Control (ECC) incorporating air conditioning i see page 52 • Cruise control • Multi-function trip computer • Graphic information display					○	○ ⁴	○ ⁴	434.78	500.00
Safety options									
Electronic Stability Programme-plus (ESP-plus) with traction control	○	○	○	○	○	○	●	386.96	445.00
ISOFIX child seat restraint system for front passenger's seat (does not include child seat)	○	○	○	○	○	○	○	91.30	105.00
Exterior and convenience options									
17-inch alloy wheels with 215/45 R 17 ultra-low profile tyres					○ ⁵	○ ⁵	●	269.57	310.00
Adaptive Forward Lighting (AFL) – halogen i see page 52					○	○	○	226.09	260.00
Electrically operated sliding glass sunroof with interior blind ⁶			●	○	○	○	○	495.65	570.00
Flex-Fix® integrated carrier system (includes two-bicycle carrier attachment) ⁷				○	○	○	○	369.57	425.00
Rear parking distance sensors ⁸ i see page 51				○	○	○	○	226.09	260.00
Two-coat metallic or pearlescent paint	○	○	○	○	○	○	○	343.48	395.00
Audio and communication options									
CD 60 • Satellite navigation system • CD player with MP3 format • Stereo radio • Auxiliary-in socket • Graphic display				○	○	○	○	830.43	955.00
Mobile phone system with Bluetooth® (does not include phone or cradle) and graphic display – see page 57 for details of mobile phone compatibility i see page 50				○	○	○	○	256.52	295.00

○ = Optional at extra cost. ● = Standard equipment.

¹ = Not available in conjunction with Flex-Fix® integrated carrier system. The spare wheel is replaced by an emergency tyre inflation kit. ² = Not available on 1.3CDTi 16v (75PS) models. ³ = Deletes sports steering wheel. ⁴ = Only available on models fitted with air conditioning. ⁵ = Not available on 1.3CDTi 16v (75PS) models. Includes sports suspension with lower ride height and progressive-rate variable ratio power-assisted steering. ⁶ = Also includes front map reading lights and front passenger's seat height adjuster. Deletes front passenger's underseat storage tray. Roof panel is coloured black. ⁷ = Not available in conjunction with VXR Styling Pack One or rear parking distance sensors. The spare wheel is replaced by an emergency tyre inflation kit. ⁸ = Not available in conjunction with Flex-Fix® integrated carrier system.

Accessory highlights

	Price (£) exc. VAT	Total (£) inc. VAT
Corsa accessories		
Safety Pack • First aid kit • Warning triangle • Hi-visibility vest	21.28	24.47
Protection Pack • Velour mats (four) • Mudflaps (four) • Cargo liner	135.32	155.62

For further details of accessories and styling products see pages 54-57.



5-door MPV

Model	Price (£)	VAT (£)	Total (£)	On-the-road RRP (£)	CO ₂ * (g/km)
Meriva Expression					
1.4i 16v	9082.61	1362.39	10445.00	11235.00	148
<i>Diesel</i>					
1.3CDTi 16v	9747.83	1462.17	11210.00	12000.00	135
Meriva Life					
1.4i 16v	10186.96	1528.04	11715.00	12505.00	148
1.6i 16v	10760.87	1614.13	12375.00	13190.00	159
1.6i 16v Easytronic	11186.96	1678.04	12865.00	13680.00	159
1.4i 16v (a/c)	10613.04	1591.96	12205.00	12995.00	148
1.6i 16v (a/c)	11186.96	1678.04	12865.00	13680.00	159
1.6i 16v Easytronic (a/c)	11613.04	1741.96	13355.00	14170.00	159
<i>Diesel</i>					
1.3CDTi 16v	11278.26	1691.74	12970.00	13760.00	135
1.3CDTi 16v (a/c)	11704.35	1755.65	13460.00	14250.00	135
Meriva Active (Special Edition model)					
1.4i 16v (a/c)	11073.91	1661.09	12735.00	13525.00	148
1.6i 16v (a/c)	11647.83	1747.17	13395.00	14210.00	159
1.6i 16v Easytronic (a/c)	12073.91	1811.09	13885.00	14700.00	159
<i>Diesel</i>					
1.3CDTi 16v (a/c)	12165.22	1824.78	13990.00	14780.00	135
Meriva Active Plus (Special Edition model)					
1.4i 16v (a/c)	11456.52	1718.48	13175.00	13965.00	148
1.6i 16v (a/c)	12030.43	1804.57	13835.00	14650.00	159
1.6i 16v Easytronic (a/c)	12456.52	1868.48	14325.00	15140.00	159
<i>Diesel</i>					
1.3CDTi 16v (a/c)	12547.83	1882.17	14430.00	15220.00	135
Meriva Club					
1.4i 16v (a/c)	11678.26	1751.74	13430.00	14220.00	148
1.6i 16v (a/c)	12252.17	1837.83	14090.00	14905.00	159
1.6i 16v Easytronic (a/c)	12678.26	1901.74	14580.00	15395.00	159
1.8i 16v (a/c)	12847.83	1927.17	14775.00	15615.00	174
1.8i 16v Easytronic (a/c)	13273.91	1991.09	15265.00	16105.00	174
<i>Diesel</i>					
1.3CDTi 16v (a/c)	12769.57	1915.43	14685.00	15475.00	135
1.7CDTi 16v (a/c)	13408.70	2011.30	15420.00	16210.00	139

Model	Price (£)	VAT (£)	Total (£)	On-the-road RRP (£)	CO ₂ * (g/km)
Meriva Design					
1.4i 16v (a/c)	11891.30	1783.70	13675.00	14465.00	148
1.6i 16v (a/c)	12465.22	1869.78	14335.00	15150.00	159
1.6i 16v Easytronic (a/c)	12891.30	1933.70	14825.00	15640.00	159
1.8i 16v (a/c)	13060.87	1959.13	15020.00	15860.00	174
1.8i 16v Easytronic (a/c)	13486.96	2023.04	15510.00	16350.00	174
<i>Diesel</i>					
1.7CDTi 16v (a/c)	13621.74	2043.26	15665.00	16455.00	139
Meriva Design with Exterior Pack**					
1.4i 16v (a/c)	12526.09	1878.91	14405.00	15195.00	148
1.6i 16v (a/c)	13100.00	1965.00	15065.00	15880.00	159
1.6i 16v Easytronic (a/c)	13526.09	2028.91	15555.00	16370.00	159
1.8i 16v (a/c)	13695.65	2054.35	15750.00	16590.00	174
1.8i 16v Easytronic (a/c)	14121.74	2118.26	16240.00	17080.00	174
<i>Diesel</i>					
1.7CDTi 16v (a/c)	14256.52	2138.48	16395.00	17185.00	139

Please note: On-the-road recommended retail prices (RRP) include number plates and delivery to retailer of £615.00 (inc. £80.22 VAT), 12 months' Vehicle Excise Duty (see page 2) and new vehicle first registration fee of £55.00. Excludes fuel and insurance.

* = CO₂ emission figures. Vehicle Excise Duty is based on CO₂ emissions (see page 2 for details).
For benefit in kind taxation charges see page 2.

** = Exterior Pack comprises 17-inch five-spoke alloy wheels and VXR Styling Pack One (see page 13 for details).

a/c = Air conditioning.

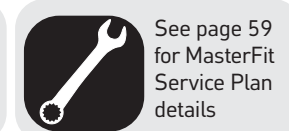
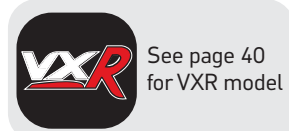

Accessory highlights

Meriva accessories

	Price (£) exc. VAT	Total (£) inc. VAT
Safety Pack		
• First aid kit • Warning triangle • Hi-visibility vest	21.28	24.47
Protection Pack		
• Velour mats (four) • Mudflaps (four) • Cargo liner	135.32	155.62

For further details of accessories and styling products see pages 54-57.

Option availability

	Expression	Life	Active	Active Plus	Club	Design	Price (£) exc. VAT	Total (£) inc. VAT
Option packs								
VXR Styling Pack One • Body-colour front lower spoiler/side sills/rear lower skirt/rear roof spoiler					○	○ ¹	695.65	800.00
Protection Pack ² • Electronic Stability Programme (ESP) i see page 53 • Electronic traction control with two-way intervention • Front seat side-impact airbags • Full-size curtain airbags • Active-safety front seat head restraints • Automatic front seat occupancy detection • ISOFIX child seat restraint system for front passenger's seat (does not include child seat)	○	○	○	○	○	○ ³	513.04	590.00
Plus Pack • 15-inch Structure wheels • Front fog lights • Leather-covered steering wheel • Dark-tinted Solar Protect® glass (excludes windscreen and front door windows) • Cruise control • Tilttable steering column					○		447.83	515.00
Plus Pack • Electronic Climate Control (ECC) i see page 52 • Solar Reflect® windscreen • Electro-chromatic anti-dazzle rear-view mirror • Indirect night lighting						○	360.87	415.00
Interior option								
Tilttable steering column		○	●	●	○	●	86.96	100.00
Exterior and convenience options								
16-inch alloy wheels (emergency tyre inflation kit) with locking bolts and 205/50 R 16 ultra-low profile tyres						○	226.09	260.00
15-inch steel spare wheel/tyre (in lieu of emergency tyre inflation kit) ⁴	○	○	○	○	○	○ ⁵	86.96	100.00
Adaptive Forward Lighting (AFL) – halogen i see page 52			○	○	○	○	226.09	260.00
Electrically operated slide/tilt glass front sunroof and tilttable glass rear sunroof			○	○		●	539.13	620.00
Two-coat metallic or pearlescent paint		○	○	○	○	○	343.48	395.00
Audio and communication options								
CD 30 MP3 • CD player with MP3 format • Stereo radio • Auxiliary-in socket i see page 51		○	○	○	○	● ⁶	86.96	100.00
CDC 40 • Integral six-disc CD autochanger with MP3 format • Stereo radio • Graphic display			○	○	○	○	386.96	445.00
CD 70 • Satellite navigation system • CD player with MP3 format • Stereo radio • Auxiliary-in socket • Graphic display i see page 50			○	○	○	○	830.43	955.00
Rear seat Twin Audio® system with single headset i see page 50			○ ⁷	○ ⁷	○ ⁷	●	91.30	105.00
Mobile phone system with Bluetooth® (does not include phone or cradle) and graphic display ⁸ – see page 57 for details of mobile phone compatibility i see page 50			○	○	○		256.52	295.00

○ = Optional at extra cost. ● = Standard equipment.

1 = Standard on Design with Exterior Pack models. **2** = For details on the correct fitment of child seats when the vehicle is fitted with a front passenger's airbag or side-impact airbags please consult your Vauxhall retailer. **3** = Deletes driver's sunglasses holder. **4** = Includes storage compartments under luggage compartment floor. **5** = Not available on Design with Exterior Pack models, or in conjunction with VXR Styling Pack One. **6** = Does not include auxiliary-in socket. **7** = Only available in conjunction with optional audio units. Deletes auxiliary-in socket from CD 30 MP3. Not available in conjunction with mobile phone system with Bluetooth®. **8** = Not available in conjunction with rear seat Twin Audio®.

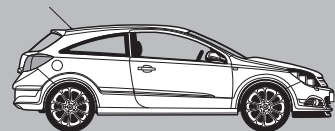

Sport Hatch

Model	Price (£)	VAT (£)	Total (£)	On-the-road RRP (£)	CO ₂ * (g/km)
Astra Active (Special Edition model)					
1.4i 16v	12569.57	1885.43	14455.00	15245.00	146
1.6i 16v VVT	13104.35	1965.65	15070.00	15885.00	155
1.8i 16v VVT auto	14482.61	2172.39	16655.00	17495.00	184
<i>Diesel</i>					
1.7CDTi 16v (100PS)	14217.39	2132.61	16350.00	17140.00	135
1.7CDTi 16v (110PS) ecoFLEX	14565.22	2184.78	16750.00	17455.00	119
Astra Active Plus (Special Edition model)					
1.4i 16v	12952.17	1942.83	14895.00	15685.00	146
1.6i 16v VVT	13486.96	2023.04	15510.00	16325.00	155
1.8i 16v VVT auto	14865.22	2229.78	17095.00	17935.00	184
<i>Diesel</i>					
1.7CDTi 16v (100PS)	14600.00	2190.00	16790.00	17580.00	135
1.7CDTi 16v (110PS) ecoFLEX	14947.83	2242.17	17190.00	17895.00	119
Astra Design					
1.6i 16v VVT	13800.00	2070.00	15870.00	16685.00	155
1.6i 16v VVT Easytronic	14226.09	2133.91	16360.00	17175.00	151
1.8i 16v VVT	14243.48	2136.52	16380.00	17220.00	169
1.8i 16v VVT auto	15178.26	2276.74	17455.00	18295.00	184
1.6i 16v Turbo	16186.96	2428.04	18615.00	19455.00	185
<i>Diesel</i>					
1.7CDTi 16v (100PS)	14913.04	2236.96	17150.00	17940.00	135
1.7CDTi 16v (110PS) ecoFLEX	15260.87	2289.13	17550.00	18255.00	119
1.9CDTi (120PS)	15639.13	2345.87	17985.00	18775.00	149
1.9CDTi (120PS) auto	16756.52	2513.48	19270.00	20150.00	186
1.9CDTi 16v (150PS)	16365.22	2454.78	18820.00	19610.00	149

Please note: On-the-road recommended retail prices (RRP) include number plates and delivery to retailer of £615.00 (inc. £80.22 VAT), 12 months' Vehicle Excise Duty (see page 2) and new vehicle first registration fee of £55.00. Excludes fuel and insurance.

* = CO₂ emission figures. Vehicle Excise Duty is based on CO₂ emissions (see page 2 for details). For benefit in kind taxation charges see page 2.

** = Exterior Pack comprises 18-inch five-spoke alloy wheels and VXR Styling Pack One (see page 15 for details).

Model	Price (£)	VAT (£)	Total (£)	On-the-road RRP (£)	CO ₂ * (g/km)
Astra SXi					
1.4i 16v	12965.22	1944.78	14910.00	15700.00	146
1.6i 16v VVT	13495.65	2024.35	15520.00	16335.00	155
1.6i 16v VVT Easytronic	13921.74	2088.26	16010.00	16825.00	151
<i>Diesel</i>					
1.7CDTi 16v (100PS)	14608.70	2191.30	16800.00	17590.00	135
1.7CDTi 16v (110PS) ecoFLEX	14956.52	2243.48	17200.00	17905.00	119
1.9CDTi (120PS)	14734.78	2210.22	16945.00	17735.00	149
Astra SRI					
1.8i 16v VVT	14526.09	2178.91	16705.00	17545.00	172
1.8i 16v VVT auto	15426.09	2313.91	17740.00	18620.00	186
1.6i 16v Turbo	15930.43	2389.57	18320.00	19160.00	185
<i>Diesel</i>					
1.7CDTi 16v (100PS)	15208.70	2281.30	17490.00	18280.00	138
1.9CDTi (120PS)	15678.26	2351.74	18030.00	18820.00	149
1.9CDTi (120PS) auto	16795.65	2519.35	19315.00	20195.00	186
1.9CDTi 16v (150PS)	16104.35	2415.65	18520.00	19310.00	149
Astra SRI with Exterior Pack**					
1.8i 16v VVT	15291.30	2293.70	17585.00	18425.00	172
1.8i 16v VVT auto	16191.30	2428.70	18620.00	19500.00	186
1.6i 16v Turbo	16695.65	2504.35	19200.00	20040.00	185
<i>Diesel</i>					
1.7CDTi 16v (100PS)	15973.91	2396.09	18370.00	19160.00	138
1.9CDTi (120PS)	16443.48	2466.52	18910.00	19700.00	149
1.9CDTi (120PS) auto	17560.87	2634.13	20195.00	21075.00	186
1.9CDTi 16v (150PS)	16869.57	2530.43	19400.00	20190.00	149

Accessory highlights

Astra Sport Hatch accessories

	Price (£) exc. VAT	Total (£) inc. VAT
Safety Pack • First aid kit • Warning triangle • Hi-visibility vest	21.28	24.47
Protection Pack • Velour mats (four) • Mudflaps (four) • Cargo liner	135.32	155.62

For further details of accessories and styling products see pages 54-57.

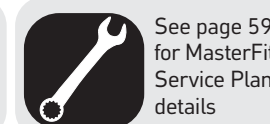
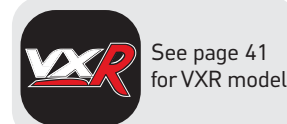

Option availability

	Active	Active Plus	Design	SXi	SRI	Price (£) exc. VAT	Total (£) inc. VAT
Option packs							
Sight and Light Pack ¹ • Rain-sensitive windscreen wipers • Electro-chromatic anti-dazzle rear-view mirror • Automatic lighting control	●	●	●	○	○	173.91	200.00
Leather Pack • Leather seat facings • Electrically heated sports front seats with tilt and lumbar adjustment • Centre rear seat head restraint • Front passenger's seat height adjuster • Active-safety front seat head restraints				○	○	882.61	1015.00
Sports Pack • 17-inch 10-spoke alloy wheels with 225/45 R 17 tyres • Uprated sports steering • Electronic Stability Programme-plus (ESP-plus) i see page 53 • Sport switch			○ ²			586.96	675.00
Premium Pack • 18-inch five-spoke alloy wheels with 225/40 R 18 ultra-low profile tyres • Leather seat facings in Saddle Brown • Electrically heated sports front seats • Zebrano-effect inserts on fascia and doors			○ ³			1021.74	1175.00
VXR Styling Pack One • Body-colour front lower spoiler/rear lower skirt/rear roof spoiler (standard on SRI models) and side sills • Aerial adaptor			○ ⁴	○ ⁴	○ ⁵	695.65	800.00
Seat Comfort Pack One • Driver's seat with tilt and lumbar adjustment	○	○	●	○	○	139.13	160.00
Seat Comfort Pack Two • Front passenger's seat with height, tilt and lumbar adjustment • Active-safety front seat head restraints	○ ⁶	○ ⁶	○	○ ⁶	○ ⁶	121.74	140.00
Safety and security options							
Electronic Stability Programme-plus (ESP-plus) i see page 53	○	○	○ ⁷	○	●	386.96	445.00
Keyless entry and start i see page 51	○	○	○	○	○	269.57	310.00
Remote control ultrasonic security alarm ⁸	○	○	○	○	●	204.35	235.00
Interior options							
Electronic Climate Control (ECC) incorporating air conditioning i see page 52		●	○	○	○	247.83	285.00
Cruise control	○	○	○	○	○	182.61	210.00
Mechanical option							
Interactive Driving System-plus (IDS-plus) with Continuous Damping Control (CDC) i see page 53			○ ⁹		○	369.57	425.00
Exterior and convenience options							
Panoramic windscreen ¹⁰			○	○	○ ¹¹	782.61	900.00
Electrically foldable door mirrors			○	○	○	139.13	160.00
Adaptive Forward Lighting (AFL) incorporating bi-xenon headlights with high-pressure washers i see page 52			○	○	○	639.13	735.00
18-inch five-spoke alloy wheels with 225/40 R 18 tyres					○ ⁵	304.35	350.00
Full-size steel spare wheel/tyre (in lieu of space-saver spare)	○	○	○ ¹²	○	○ ¹³	86.96	100.00
Rear parking distance sensor i see page 51			○	○	○	317.39	365.00
Two-coat metallic or pearlescent paint	○	○	○	○	○	343.48	395.00
Audio and communication options							
CDC 40 • Integral six-disc CD autochanger with MP3 format • Stereo radio • Graphic display ¹⁴			○	○	○	343.48	395.00
CDC 40 DAB • Integral six-disc CD autochanger with MP3 format • Stereo radio with Digital Audio Broadcast (DAB) • Graphic display ¹⁵	○	○	○	○		391.30	450.00
CD 70 • Satellite navigation system • CD player with MP3 format • Stereo radio • Auxiliary-in socket • Colour monitor i see page 50			○	○	○	1065.22	1225.00
Mobile phone system with Bluetooth® (does not include phone or cradle) ¹ – see page 57 for mobile phone compatibility i see page 50	○	○	○	○	○	256.52	295.00

○ = Optional at extra cost. ● = Standard equipment.

¹ = Not available in conjunction with panoramic windscreen. ² = Standard on 1.6i 16v Turbo and 1.9CDTi 16v (150PS) models. Not available on 1.7CDTi 16v (110PS) ecoFLEX models or on models fitted with Easytronic transmission. 17-inch alloy wheels will affect the Vehicle Excise Duty payable on 1.8i 16v VVT automatic models – see page 2 for details. In addition, due to increased CO₂ emissions, on certain engines there will be a slight increase in benefit in kind charges for company car drivers. CO₂ emissions figures: 1.8i 16v VVT (manual) – 172g/km; 1.8i 16v VVT (automatic) – 186g/km. ³ = Only available on 1.6i 16v Turbo and 1.9CDTi 16v (150PS) models. Not available in conjunction with Power Red solid paint. ⁴ = Not available on 1.7CDTi 16v (110PS) ecoFLEX models. ⁵ = Standard on SRI with Exterior Pack models. ⁶ = Only available in conjunction with Seat Comfort Pack One. ⁷ = Standard on 1.6i 16v Turbo and 1.9CDTi diesel models. ⁸ = If fitted in conjunction with panoramic windscreen, ultrasonic sensors are deleted. ⁹ = Only available in conjunction with Sports Pack (Sports Pack is standard on 1.6i 16v Turbo and 1.9CDTi 16v (150PS) models). Not available on 1.7CDTi 16v (110PS) ecoFLEX models. ¹⁰ = Not available in conjunction with Sight and Light Pack or mobile phone system with Bluetooth®. Roof panel is coloured black. Deletes illuminated driver's and front passenger's vanity mirrors, front map reading lights, body-colour roof mouldings and driver's sunglasses holder. Not available in conjunction with Olympic White solid paint. ¹¹ = Deletes ultrasonic sensors from remote control security alarm system. ¹² = 16-inch steel spare wheel/tyre supplied if ordered in conjunction with Sports Pack. Not available in conjunction with Premium Pack. ¹³ = 16-inch steel spare wheel/tyre. Not available on SRI with Exterior Pack models or in conjunction with optional 18-inch alloy wheels. ¹⁴ = Deletes auxiliary-in socket. ¹⁵ = Deletes auxiliary-in socket. Not available in conjunction with VXR Styling Pack One.

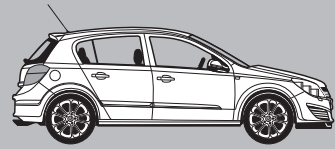

5-door hatchback

Model	Price (£)	VAT (£)	Total (£)	On-the-road RRP (£)	CO ₂ * (g/km)
Astra Expression					
1.4i 16v	10230.43	1534.57	11765.00	12555.00	146
Astra Life					
1.4i 16v	11643.48	1746.52	13390.00	14180.00	146
1.6i 16v VVT	12178.26	1826.74	14005.00	14820.00	155
1.6i 16v VVT Easytronic	12604.35	1890.65	14495.00	15310.00	151
1.8i 16v VVT	12621.74	1893.26	14515.00	15355.00	169
1.8i 16v VVT auto	13556.52	2033.48	15590.00	16430.00	184
1.4i 16v (a/c)	12069.57	1810.43	13880.00	14670.00	146
1.6i 16v VVT (a/c)	12604.35	1890.65	14495.00	15310.00	155
1.6i 16v VVT Easytronic (a/c)	13030.43	1954.57	14985.00	15800.00	151
1.8i 16v VVT (a/c)	13047.83	1957.17	15005.00	15845.00	169
1.8i 16v VVT auto (a/c)	13982.61	2097.39	16080.00	16920.00	184
Diesel					
1.3CDTi 16v (90PS)	12995.65	1949.35	14945.00	15735.00	130
1.3CDTi 16v (90PS) (a/c)	13421.74	2013.26	15435.00	16225.00	130
1.7CDTi 16v (100PS) (a/c)	13717.39	2057.61	15775.00	16565.00	135
1.7CDTi 16v (110PS) ecoFLEX (a/c)	14065.22	2109.78	16175.00	16880.00	119
Astra Club					
1.4i 16v	12539.13	1880.87	14420.00	15210.00	146
1.6i 16v VVT	13073.91	1961.09	15035.00	15850.00	155
1.6i 16v VVT Easytronic	13500.00	2025.00	15525.00	16340.00	151
1.8i 16v VVT	13517.39	2027.61	15545.00	16385.00	169
1.8i 16v VVT auto	14452.17	2167.83	16620.00	17460.00	184
Diesel					
1.3CDTi 16v (90PS)	13891.30	2083.70	15975.00	16765.00	130
1.7CDTi 16v (100PS)	14186.96	2128.04	16315.00	17105.00	138
1.7CDTi 16v (110PS) ecoFLEX	14534.78	2180.22	16715.00	17420.00	119



See pages 54-57 for accessory and styling products



See page 45 for fuel data



See page 59 for MasterFit Service Plan details

Model	Price (£)	VAT (£)	Total (£)	On-the-road RRP (£)	CO ₂ * (g/km)
Astra Active (Special Edition model)					
1.4i 16v	12569.57	1885.43	14455.00	15245.00	146
1.6i 16v VVT	13104.35	1965.65	15070.00	15885.00	155
1.8i 16v VVT auto	14482.61	2172.39	16655.00	17495.00	184
Diesel					
1.7CDTi 16v (100PS)	14217.39	2132.61	16350.00	17140.00	138
1.7CDTi 16v (110PS) ecoFLEX	14565.22	2184.78	16750.00	17455.00	119
Astra Active Plus (Special Edition model)					
1.4i 16v	12952.17	1942.83	14895.00	15685.00	146
1.6i 16v VVT	13486.96	2023.04	15510.00	16325.00	155
1.8i 16v VVT auto	14865.22	2229.78	17095.00	17935.00	184
Diesel					
1.7CDTi 16v (100PS)	14600.00	2190.00	16790.00	17580.00	138
1.7CDTi 16v (110PS) ecoFLEX	14947.83	2242.17	17190.00	17895.00	119
Astra Design					
1.6i 16v VVT	13800.00	2070.00	15870.00	16685.00	155
1.6i 16v VVT Easytronic	14226.09	2133.91	16360.00	17175.00	151
1.8i 16v VVT	14243.48	2136.52	16380.00	17220.00	169
1.8i 16v VVT auto	15178.26	2276.74	17455.00	18295.00	184
1.6i 16v Turbo	16186.96	2428.04	18615.00	19455.00	185
Diesel					
1.7CDTi 16v (100PS)	14913.04	2236.96	17150.00	17940.00	138
1.7CDTi 16v (110PS) ecoFLEX	15260.87	2289.13	17550.00	18255.00	119
1.9CDTi (120PS)	15639.13	2345.87	17985.00	18775.00	149
1.9CDTi (120PS) auto	16756.52	2513.48	19270.00	20150.00	186
1.9CDTi 16v (150PS)	16365.22	2454.78	18820.00	19610.00	149

Please note: On-the-road recommended retail prices (RRP) include number plates and delivery to retailer of £615.00 (inc. £80.22 VAT), 12 months' Vehicle Excise Duty (see page 2) and new vehicle first registration fee of £55.00. Excludes fuel and insurance.

* = CO₂ emission figures. Vehicle Excise Duty is based on CO₂ emissions (see page 2 for details). For benefit in kind taxation charges see page 2.
a/c = Air conditioning.

Accessory highlights

Astra accessories

	Price (£) exc. VAT	Total (£) inc. VAT
Safety Pack		
• First aid kit • Warning triangle • Hi-visibility vest	21.28	24.47
Protection Pack		
• Velour mats (four) • Mudflaps (four) • Cargo liner	135.32	155.62

For further details of accessories and styling products see pages 54-57.

Option availability

	Expression	Life	Club	Active	Active Plus	Design	Price (£) exc. VAT	Total (£) inc. VAT
Option packs								
Sports Pack • 17-inch 10-spoke alloy wheels with 225/45 R 17 tyres • Uprated sports suspension • Uprated sports steering • Electronic Stability Programme-plus (ESP-plus) i see page 53 • Sport switch						○ ¹	586.96	675.00
VXR Styling Pack One ² • Body-colour front lower spoiler/rear lower skirt/rear roof spoiler and side sills • Aerial adaptor			○			○	695.65	800.00
Seat Comfort Pack One • Driver's seat with tilt and lumbar adjustment			○	○	○	●	139.13	160.00
Seat Comfort Pack Two • Front passenger's seat with height, tilt and lumbar adjustment • Active-safety front seat head restraints			○ ³	○ ³	○ ³	○	121.74	140.00
Safety and security options								
Electronic Stability Programme-plus (ESP-plus) i see page 53	○	○	○	○	○	○ ⁴	386.96	445.00
Keyless entry and start i see page 51			○	○	○	○	269.57	310.00
Remote control ultrasonic security alarm		○	○	○	○	○	204.35	235.00
Interior options								
Electronic Climate Control (ECC) incorporating air conditioning i see page 52			○		●	○	247.83	285.00
Cruise control			○	○	○	○	182.61	210.00
Mechanical option								
Interactive Driving System-plus (IDS-plus) with Continuous Damping Control (CDC) i see page 53						○ ⁵	369.57	425.00
Exterior and convenience options								
Electrically operated full-length slide/tilt sunroof			○			○	539.13	620.00
Electrically foldable door mirrors			○			○	139.13	160.00
Adaptive Forward Lighting (AFL) incorporating dark-style bi-xenon headlights with high-pressure washers i see page 52						○	639.13	735.00
Full-size steel spare wheel/tyre (in lieu of space-saver spare)	○	○	○	○	○	○ ⁶	86.96	100.00
Rear parking distance sensor i see page 51			○			○	317.39	365.00
Two-coat metallic or pearlescent paint	○	○	○	○	○	○	343.48	395.00
Audio and communication options								
CD 30 MP3 • CD player with MP3 format • Stereo radio • Auxiliary-in socket i see page 51		○ ⁷	○	●	●	●	69.57	80.00
CDC 40 • Integral six-disc CD autochanger with MP3 format • Stereo radio • Graphic display		○ ⁷	○			○ ⁸	343.48	395.00
CDC 40 DAB • Integral six-disc CD autochanger with MP3 format • Stereo radio with Digital Audio Broadcast (DAB) • Graphic display ⁹		○ ⁷	○	○ ⁸	○ ⁸	○ ⁸	391.30	450.00
CD 70 • Satellite navigation system • CD player with MP3 format • Stereo radio • Auxiliary-in socket • Colour monitor i see page 50		○ ⁷	○			○	1065.22	1225.00
Mobile phone system with Bluetooth® (does not include phone or cradle) – see page 57 for mobile phone compatibility i see page 50		○ ⁷	○	○	○	○	256.52	295.00

○ = Optional at extra cost. ● = Standard equipment.

1 = Standard on 1.6i 16v Turbo and 1.9CDTi 16v (110PS) models. Not available on 1.7CDTi 16v (110PS) ecoFLEX models or on models fitted with Easytronic transmission. Due to increased CO₂ emissions, on certain engines there will be a slight increase in benefit in kind charges for company car drivers. CO₂ emissions figures: 1.8i 16v VVT (manual) – 172g/km; 1.8i 16v VVT (automatic) – 186g/km. **2** = Not available on 1.7CDTi 16v (110PS) ecoFLEX models. **3** = Only available in conjunction with Seat Comfort Pack One. **4** = Standard on 1.6i 16v Turbo and 1.9CDTi diesel models. **5** = Only available in conjunction with Sports Pack (Sports Pack is standard on 1.6i 16v Turbo and 1.9CDTi 16v (150PS) models). Not available on 1.7CDTi 16v (110PS) ecoFLEX models. **6** = 16-inch steel spare wheel/tyre supplied if ordered in conjunction with Sports Pack. **7** = Includes steering wheel mounted audio controls. **8** = Deletes auxiliary-in socket. **9** = Not available in conjunction with VXR Styling Pack One.

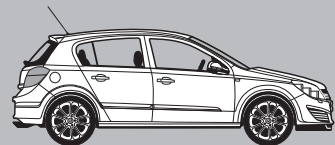

5-door hatchback

Model	Price (£)	VAT (£)	Total (£)	On-the-road RRP (£)	CO ₂ * (g/km)
Astra Elite					
1.6i 16v VVT	14721.74	2208.26	16930.00	17745.00	155
1.6i 16v VVT Easytronic	15147.83	2272.17	17420.00	18235.00	151
1.8i 16v VVT	15165.22	2274.78	17440.00	18280.00	169
1.8i 16v VVT auto	16100.00	2415.00	18515.00	19355.00	184
<i>Diesel</i>					
1.7CDTi 16v (100PS)	15834.78	2375.22	18210.00	19000.00	138
1.9CDTi (120PS)	16560.87	2484.13	19045.00	19835.00	149
1.9CDTi (120PS) auto	17678.26	2651.74	20330.00	21210.00	186
Astra SXi					
1.4i 16v	12965.22	1944.78	14910.00	15700.00	146
1.6i 16v VVT	13495.65	2024.35	15520.00	16335.00	155
1.6i 16v VVT Easytronic	13921.74	2088.26	16010.00	16825.00	151
<i>Diesel</i>					
1.7CDTi 16v (100PS)	14608.70	2191.30	16800.00	17590.00	138
1.7CDTi 16v (110PS) ecoFLEX	14956.52	2243.48	17200.00	17905.00	119
1.9CDTi (120PS)	14734.78	2210.22	16945.00	17735.00	149
Astra SRi					
1.8i 16v VVT	14526.09	2178.91	16705.00	17545.00	172
1.8i 16v VVT auto	15426.09	2313.91	17740.00	18620.00	186
1.6i 16v Turbo	15930.43	2389.57	18320.00	19160.00	185
<i>Diesel</i>					
1.7CDTi 16v (100PS)	15208.70	2281.30	17490.00	18280.00	138
1.9CDTi (120PS)	15678.26	2351.74	18030.00	18820.00	149
1.9CDTi (120PS) auto	16795.65	2519.35	19315.00	20195.00	186
1.9CDTi 16v (150PS)	16104.35	2415.65	18520.00	19310.00	149

Model	Price (£)	VAT (£)	Total (£)	On-the-road RRP (£)	CO ₂ * (g/km)
Astra SRi with Exterior Pack**					
1.8i 16v VVT	15291.30	2293.70	17585.00	18425.00	172
1.8i 16v VVT auto	16191.30	2428.70	18620.00	19500.00	186
1.6i 16v Turbo	16695.65	2504.35	19200.00	20040.00	185
<i>Diesel</i>					
1.7CDTi 16v (100PS)	15973.91	2396.09	18370.00	19160.00	138
1.9CDTi (120PS)	16443.48	2466.52	18910.00	19700.00	149
1.9CDTi (120PS) auto	17560.87	2634.13	20195.00	21075.00	186
1.9CDTi 16v (150PS)	16869.57	2530.43	19400.00	20190.00	149

Please note: On-the-road recommended retail prices (RRP) include number plates and delivery to retailer of £615.00 (inc. £80.22 VAT), 12 months' Vehicle Excise Duty (see page 2) and new vehicle first registration fee of £55.00. Excludes fuel and insurance.

* = CO₂ emission figures. Vehicle Excise Duty is based on CO₂ emissions (see page 2 for details). For benefit in kind taxation charges see page 2.

** = Exterior Pack comprises 18-inch five-spoke alloy wheels and VXR Styling Pack One (see page 19 for details).



See pages 54-57 for accessory and styling products



See page 45 for fuel data



See page 59 for MasterFit Service Plan details

Accessory highlights

Astra accessories

	Price (£) exc. VAT	Total (£) inc. VAT
Safety Pack		
• First aid kit • Warning triangle • Hi-visibility vest	21.28	24.47
Protection Pack		
• Velour mats (four) • Mudflaps (four) • Cargo liner	135.32	155.62

For further details of accessories and styling products see pages 54-57.

Option availability

	Elite	SXi	SRi	Price (£) exc. VAT	Total (£) inc. VAT
Option packs					
Sight and Light Pack • Rain-sensitive windscreen wipers • Electro-chromatic anti-dazzle rear-view mirror • Automatic lighting control	●	○	○	173.91	200.00
Leather Pack • Leather seat facings • Electrically heated sports front seats with tilt and lumbar adjustment • Centre rear seat head restraint • Front passenger's seat height adjuster • Active-safety front seat head restraints	●	○	○	882.61	1015.00
VXR Styling Pack One • Body-colour front lower spoiler/rear lower skirt/rear roof spoiler (standard on SRi models) and side sills • Aerial adaptor	○	○ ¹	○ ²	695.65	800.00
Seat Comfort Pack One • Driver's seat with tilt and lumbar adjustment	●	○	○	139.13	160.00
Seat Comfort Pack Two ³ • Front passenger's seat with height, tilt and lumbar adjustment • Active-safety front seat head restraints	●	○	○	121.74	140.00
Safety and security options					
Electronic Stability Programme-plus (ESP-plus) ⓘ see page 53	○ ⁴	○	●	386.96	445.00
Keyless entry and start ⓘ see page 51	○	○	○	269.57	310.00
Remote control ultrasonic security alarm	○	○	●	204.35	235.00
Interior options					
Electronic Climate Control (ECC) incorporating air conditioning ⓘ see page 52	●	○	○	247.83	285.00
Cruise control	●	○	○	182.61	210.00
Mechanical option					
Interactive Driving System-plus (IDS-plus) with Continuous Damping Control (CDC) ⓘ see page 53			○	369.57	425.00
Exterior and convenience options					
Electrically operated full-length slide/tilt sunroof	○	○	○	539.13	620.00
Electrically foldable door mirrors	●	○	○	139.13	160.00
Adaptive Forward Lighting (AFL) incorporating dark-style bi-xenon headlights with high-pressure washers ⓘ see page 52	○	○	○	639.13	735.00
18-inch five-spoke alloy wheels with 225/40 R 18 tyres			○ ²	304.35	350.00
Full-size steel spare wheel/tyre (in lieu of space-saver spare)	○	○	○ ⁵	86.96	100.00
Rear parking distance sensor ⓘ see page 51	○	○	○	317.39	365.00
Two-coat metallic or pearlescent paint	○	○	○	343.48	395.00
Audio and communication options					
CDC 40 • Integral six-disc CD autochanger with MP3 format • Stereo radio • Graphic display ⁶	○	○	○	343.48	395.00
CDC 40 DAB • Integral six-disc CD autochanger with MP3 format • Stereo radio with Digital Audio Broadcast (DAB) • Graphic display ⁷	○	○		391.30	450.00
CD 70 • Satellite navigation system • CD player with MP3 format • Stereo radio • Auxiliary-in socket • Colour monitor ⓘ see page 50	○	○	○	1065.22	1225.00
Mobile phone system with Bluetooth® (does not include phone or cradle) – see page 57 for mobile phone compatibility ⓘ see page 50	○	○	○	256.52	295.00

○ = Optional at extra cost. ● = Standard equipment

¹ = Not available on 1.7CDTi 16v (110PS) ecoFLEX models. ² = Standard on SRi with Exterior Pack models. ³ = Only available in conjunction with Seat Comfort Pack One. ⁴ = Standard on 1.9CDTi diesel models. ⁵ = 16-inch steel spare wheel/tyre. Not available on SRi with Exterior Pack models or in conjunction with optional 18-inch alloy wheels. ⁶ = Deletes auxiliary-in socket. ⁷ = Deletes auxiliary-in socket. Not available in conjunction with VXR Styling Pack One.



5-door estate

Model	Price (£)	VAT (£)	Total (£)	On-the-road RRP (£)	CO ₂ * (g/km)
Astra Life					
1.4i 16v	12408.70	1861.30	14270.00	15060.00	146
1.6i 16v VVT	12943.48	1941.52	14885.00	15700.00	158
1.6i 16v VVT Easytronic	13369.57	2005.43	15375.00	16190.00	153
1.8i 16v VVT	13378.26	2006.74	15385.00	16225.00	169
1.8i 16v VVT auto	14278.26	2141.74	16420.00	17300.00	186
1.4i 16v (a/c)	12834.78	1925.22	14760.00	15550.00	146
1.6i 16v VVT (a/c)	13369.57	2005.43	15375.00	16190.00	158
1.6i 16v VVT Easytronic (a/c)	13795.65	2069.35	15865.00	16680.00	153
1.8i 16v VVT (a/c)	13804.35	2070.65	15875.00	16715.00	169
1.8i 16v VVT auto (a/c)	14704.35	2205.65	16910.00	17790.00	186
Diesel					
1.3CDTi 16v (90PS)	13760.87	2064.13	15825.00	16615.00	130
1.3CDTi 16v (90PS) (a/c)	14186.96	2128.04	16315.00	17105.00	130
1.7CDTi 16v (100PS) (a/c)	14482.61	2172.39	16655.00	17445.00	135
1.7CDTi 16v (110PS) ecoFLEX (a/c)	14830.43	2224.57	17055.00	17760.00	119
Astra Club					
1.4i 16v	13304.35	1995.65	15300.00	16090.00	146
1.6i 16v VVT	13839.13	2075.87	15915.00	16730.00	158
1.6i 16v VVT Easytronic	14265.22	2139.78	16405.00	17220.00	153
1.8i 16v VVT	14273.91	2141.09	16415.00	17255.00	169
1.8i 16v VVT auto	15173.91	2276.09	17450.00	18330.00	186
Diesel					
1.3CDTi 16v (90PS)	14656.52	2198.48	16855.00	17645.00	130
1.7CDTi 16v (100PS)	14952.17	2242.83	17195.00	17985.00	138
1.7CDTi 16v (110PS) ecoFLEX	15300.00	2295.00	17595.00	18300.00	119

Please note: On-the-road recommended retail prices (RRP) include number plates and delivery to retailer of £615.00 (inc. £80.22 VAT), 12 months' Vehicle Excise Duty (see page 2) and new vehicle first registration fee of £55.00. Excludes fuel and insurance.

* = CO₂ emission figures. Vehicle Excise Duty is based on CO₂ emissions (see page 2 for details). For benefit in kind taxation charges see page 2.

** = Exterior Pack comprises 18-inch five-spoke alloy wheels and VXR Styling Pack One (see page 21 for details).

a/c = Air conditioning.

Model	Price (£)	VAT (£)	Total (£)	On-the-road RRP (£)	CO ₂ * (g/km)
Astra Design					
1.6i 16v VVT	14565.22	2184.78	16750.00	17565.00	158
1.6i 16v VVT Easytronic	14991.30	2248.70	17240.00	18055.00	153
1.8i 16v VVT	15000.00	2250.00	17250.00	18090.00	169
1.8i 16v VVT auto	15900.00	2385.00	18285.00	19165.00	186
1.6i 16v Turbo	16952.17	2542.83	19495.00	20335.00	185
Diesel					
1.7CDTi 16v (100PS)	15678.26	2351.74	18030.00	18820.00	138
1.7CDTi 16v (110PS) ecoFLEX	16026.09	2403.91	18430.00	19135.00	119
1.9CDTi (120PS)	16408.70	2461.30	18870.00	19660.00	149
1.9CDTi (120PS) auto	17526.09	2628.91	20155.00	21035.00	189
1.9CDTi 16v (150PS)	17130.43	2569.57	19700.00	20490.00	149
Astra SXi					
1.4i 16v	13730.43	2059.57	15790.00	16580.00	146
1.6i 16v VVT	14260.87	2139.13	16400.00	17215.00	158
1.6i 16v VVT Easytronic	14686.96	2203.04	16890.00	17705.00	153
Diesel					
1.7CDTi 16v (100PS)	15378.26	2306.74	17685.00	18475.00	138
1.7CDTi 16v (110PS) ecoFLEX	15726.09	2358.91	18085.00	18790.00	119
1.9CDTi (120PS)	15500.00	2325.00	17825.00	18615.00	149
Astra SRI					
1.8i 16v VVT	15291.30	2293.70	17585.00	18425.00	172
1.8i 16v VVT auto	16191.30	2428.70	18620.00	19500.00	189
1.6i 16v Turbo	16695.65	2504.35	19200.00	20040.00	185
Diesel					
1.7CDTi 16v (100PS)	15973.91	2396.09	18370.00	19160.00	138
1.9CDTi (120PS)	16443.48	2466.52	18910.00	19700.00	149
1.9CDTi (120PS) auto	17560.87	2634.13	20195.00	21075.00	189
1.9CDTi 16v (150PS)	16869.57	2530.43	19400.00	20190.00	149
Astra SRI with Exterior Pack**					
1.8i 16v VVT	16056.52	2408.48	18465.00	19305.00	172
1.8i 16v VVT auto	16956.52	2543.48	19500.00	20380.00	189
1.6i 16v Turbo	17460.87	2619.13	20080.00	20920.00	185
Diesel					
1.7CDTi 16v (100PS)	16739.13	2510.87	19250.00	20040.00	138
1.9CDTi (120PS)	17208.70	2581.30	19790.00	20580.00	149
1.9CDTi (120PS) auto	18326.09	2748.91	21075.00	21955.00	189
1.9CDTi 16v (150PS)	17634.78	2645.22	20280.00	21070.00	149



See pages 54-57 for accessory and styling products



See page 46 for fuel data



See page 59 for MasterFit Service Plan details

Option availability

	Life	Club	Design	SXi	SRi	Price (£) exc. VAT	Total (£) inc. VAT
Option packs							
Leather Pack • Leather seat facings • Electrically heated sports front seats with tilt and lumbar adjustment • Centre rear seat head restraint • Front passenger's seat height adjuster • Active-safety front seat head restraints				○	○	882.61	1015.00
Sports Pack • 17-inch 10-spoke alloy wheels with 225/45 R 17 tyres • Uprated sports suspension • Uprated sports steering • Electronic Stability Programme-plus (ESP-plus) i see page 53 • Sport switch			○ ¹			586.96	675.00
VXR Styling Pack One • Body-colour front lower spoiler/rear lower skirt/rear roof spoiler (standard on SRi models) and side sills • Aerial adaptor		○ ²	○ ²	○ ²	○ ³	695.65	800.00
Seat Comfort Pack One • Driver's seat with tilt and lumbar adjustment		○	●	○	○	139.13	160.00
Seat Comfort Pack Two • Front passenger's seat with height, tilt and lumbar adjustment • Active-safety front seat head restraints		○ ⁴	○	○ ⁴	○ ⁴	121.74	140.00
Convenience Pack • Vertical load-restraining net • 12-volt auxiliary power socket in luggage area		○	○	○	○	156.52	180.00
FlexOrganiser® Organiser Pack • Four side rails • Divider net • Elasticated bag with four clips		○	○	○	○	43.48	50.00
Safety and security options							
Electronic Stability Programme-plus (ESP-plus) i see page 53	○	○	○ ⁵	○	●	386.96	445.00
Keyless entry and start i see page 51		○	○	○	○	269.57	310.00
Remote control ultrasonic security alarm	○	○	○	○	●	204.35	235.00
Interior options							
Electronic Climate Control (ECC) incorporating air conditioning i see page 52		○	○	○	○	247.83	285.00
Cruise control		○	○	○	○	182.61	210.00
Vertical load-restraining net	○	○	○	○	○	130.43	150.00
Mechanical option							
Interactive Driving System-plus (IDS-plus) with Continuous Damping Control (CDC) i see page 53			○ ⁶		○	369.57	425.00
Exterior and convenience options							
Electrically operated full-length slide/tilt sunroof		○	○	○	○	539.13	620.00
Electrically foldable door mirrors		○	○	○	○	139.13	160.00
Adaptive Forward Lighting (AFL) incorporating dark-style bi-xenon headlights with high-pressure washers i see page 52			○	○	○	639.13	735.00
18-inch five-spoke alloy wheels with 225/40 R 18 tyres					○ ³	304.35	350.00
Full-size steel spare wheel/tyre (in lieu of space-saver spare)	○	○	○ ⁷	○	○ ⁸	86.96	100.00
Rear parking distance sensor i see page 51		○	○	○	○	317.39	365.00
Two-coat metallic or pearlescent paint	○	○	○	○	○	343.48	395.00
Audio and communication options							
CD 30 MP3 • CD player with MP3 format • Stereo radio • Auxiliary-in socket i see page 51	○ ⁹	○	●	●	●	69.57	80.00
CDC 40 • Integral six-disc CD autochanger with MP3 format • Stereo radio • Graphic display	○ ⁹	○	○ ¹⁰	○ ¹⁰	○ ¹⁰	343.48	395.00
CDC 40 DAB • Integral six-disc CD autochanger with MP3 format • Stereo radio with Digital Audio Broadcast (DAB) • Graphic display ¹¹	○ ⁹	○	○	○		391.30	450.00
CD 70 • Satellite navigation system • CD player with MP3 format • Stereo radio • Auxiliary-in socket • Colour monitor i see page 50	○ ⁹	○	○	○	○	1065.22	1225.00
Mobile phone system with Bluetooth® (does not include phone or cradle) – see page 57 for mobile phone compatibility i see page 50	○ ⁹	○	○	○	○	256.52	295.00

○ = Optional at extra cost. ● = Standard equipment. **1** = Standard on 1.6i 16v Turbo and 1.9CDTi 16v (150PS) models. Not available on 1.7CDTi 16v (110PS) ecoFLEX models or on models fitted with Easytronic transmission. Due to increased CO₂ emissions, on certain engines there will be a slight increase in benefit in kind charges for company car drivers. CO₂ emissions figures: 1.8i 16v VVT (manual) – 172g/km. **2** = Not available on 1.7CDTi 16v (110PS) ecoFLEX models. **3** = Standard on SRi with Exterior Pack models. **4** = Only available in conjunction with Seat Comfort Pack One. **5** = Standard on 1.6i 16v Turbo and 1.9CDTi diesel models. **6** = Only available in conjunction with Sports Pack (Sports Pack is standard on 1.6i 16v Turbo and 1.9CDTi 16v (150PS) models). Not available on 1.7CDTi 16v (110PS) ecoFLEX models. **7** = 16-inch steel spare wheel/tyre supplied if ordered in conjunction with Sports Pack. **8** = 16-inch steel spare wheel/tyre. Not available on SRi with Exterior Pack models or in conjunction with optional 18-inch alloy wheels. **9** = Includes steering wheel mounted audio controls. **10** = Deletes auxiliary-in socket. **11** = Deletes auxiliary-in socket. Not available in conjunction with VXR Styling Pack One.

2-door coupé convertible

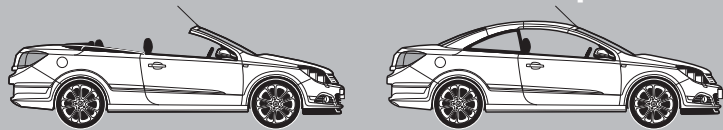

Model	Price (£)	VAT (£)	Total (£)	On-the-road RRP (£)	CO ₂ * (g/km)
Astra TwinTop Air					
1.6i 16v VVT	15691.30	2353.70	18045.00	18860.00	163
1.8i 16v VVT	16095.65	2414.35	18510.00	19350.00	177
1.8i 16v VVT auto	16965.22	2544.78	19510.00	20390.00	191
<i>Diesel</i>					
1.9CDTi 16v (150PS)	17817.39	2672.61	20490.00	21305.00	159
Astra TwinTop Sport					
1.6i 16v VVT	16413.04	2461.96	18875.00	19690.00	163
1.8i 16v VVT	16817.39	2522.61	19340.00	20180.00	177
1.8i 16v VVT auto	17686.96	2653.04	20340.00	21220.00	191
<i>Diesel</i>					
1.9CDTi 16v (150PS)	18539.13	2780.87	21320.00	22135.00	159
Astra TwinTop Design					
1.8i 16v VVT	17582.61	2637.39	20220.00	21060.00	177
1.8i 16v VVT auto	18452.17	2767.83	21220.00	22100.00	191
2.0i 16v Turbo (200PS)	19304.35	2895.65	22200.00	23270.00	228
<i>Diesel</i>					
1.9CDTi 16v (150PS)	19304.35	2895.65	22200.00	23015.00	159

Please note: On-the-road recommended retail prices (RRP) include number plates and delivery to retailer of £615.00 (inc. £80.22 VAT), 12 months' Vehicle Excise Duty (see page 2) and new vehicle first registration fee of £55.00. Excludes fuel and insurance.

* = CO₂ emission figures. Vehicle Excise Duty is based on CO₂ emissions (see page 2 for details). For benefit in kind taxation charges see page 2.

** = Exterior Pack comprises VXR Styling Pack One (see page 23 for details).

Model	Price (£)	VAT (£)	Total (£)	On-the-road RRP (£)	CO ₂ * (g/km)
Astra TwinTop Exclusiv (Special Edition model)					
1.8i 16v VVT	17013.04	2551.96	19565.00	20405.00	177
1.8i 16v VVT auto	17882.61	2682.39	20565.00	21445.00	191
2.0i 16v Turbo (200PS)	18734.78	2810.22	21545.00	22615.00	228
<i>Diesel</i>					
1.9CDTi 16v (150PS)	18734.78	2810.22	21545.00	22360.00	159
Astra TwinTop Exclusiv with Exterior Pack** (Special Edition model)					
1.8i 16v VVT	17608.70	2641.30	20250.00	21090.00	177
1.8i 16v VVT auto	18478.26	2771.74	21250.00	22130.00	191
2.0i 16v Turbo (200PS)	19330.43	2899.57	22230.00	23300.00	228
<i>Diesel</i>					
1.9CDTi 16v (150PS)	19330.43	2899.57	22230.00	23045.00	159

Accessory highlights

Astra accessories

	Price (£) exc. VAT	Total (£) inc. VAT
Safety Pack • First aid kit • Warning triangle • Hi-visibility vest	21.28	24.47
Protection Pack • Deluxe Velour mats • Windbreak	211.91	243.70

For further details of accessories and styling products see pages 54-57.



See pages 54-57 for accessory and styling products



See page 46 for fuel data



See page 59 for MasterFit Service Plan details

Option availability

	Air	Sport	Design	Exclusiv	Price (£) exc. VAT	Total (£) inc. VAT
Option packs						
Leather Pack • Leather seat facings • Electrically heated sports front seats with driver's tilt and lumbar adjustment			○	●	639.13	735.00
Plus Pack • 17-inch five-spoke alloy wheels with 225/45 R 17 ultra-low profile tyres • Cruise control		○			317.39	365.00
Plus Pack • 18-inch 11-spoke alloy wheels with 225/40 R 18 ultra-low profile tyres • Cruise control			○	●	408.70	470.00
Premium Pack • 18-inch 11-spoke alloy wheels with 225/40 R 18 ultra-low profile tyres • Cruise control • Satellite navigation with colour monitor/CD player with MP3 format/auxiliary-in socket/stereo radio (CD 70) i see page 50			○		1195.65	1375.00
VXR Styling Pack One • Body-colour front lower spoiler/rear lower skirt/rear lip spoiler and side sills		○	○	● ¹	695.65	800.00
Safety option						
Electronic Stability Programme-plus (ESP-plus) with traction control i see page 53	○ ²	○ ²	●	●	386.96	445.00
Interior options						
Electronic Climate Control (ECC) incorporating air conditioning i see page 52			○		247.83	285.00
Cruise control	○	○	○	●	182.61	210.00
Exterior and convenience options						
Adaptive Forward Lighting (AFL) incorporating dark-style bi-xenon headlights with dynamic beam levelling and high-pressure washers i see page 52			○	○	639.13	735.00
Steel space-saver spare wheel/tyre (in lieu of emergency tyre inflation kit)	○	○	○		86.96	100.00
Rear parking distance sensor i see page 51	○	○	○	○	317.39	365.00
Windbreak	○	○	●	●	130.43	150.00
Two-coat metallic or pearlescent paint	○	○	○	○	343.48	395.00
Audio and communication options						
CDC 40 • Integral six-disc CD autochanger with MP3 format • Stereo radio • Graphic display		○ ³	○ ³		386.96	445.00
CD 70 • Satellite navigation system • CD player with MP3 format • Stereo radio • Auxiliary-in socket • Colour monitor i see page 50		○	○	○	1065.22	1225.00
Mobile phone system with Bluetooth® (does not include phone or cradle) – see page 57 for details of mobile phone compatibility i see page 50	○ ⁴	○	○		256.52	295.00

○ = Optional at extra cost. ● = Standard equipment.

¹ = Standard on Exclusiv with Exterior Pack models. ² = Standard on 1.9CDTI 16v models only. ³ = Deletes auxiliary-in socket. ⁴ = Includes graphic information display.

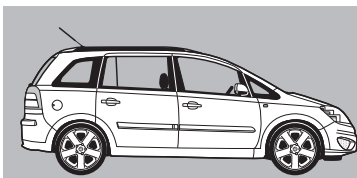

5-door MPV

Model	Price (£)	VAT (£)	Total (£)	On-the-road RRP (£)	CO ₂ * (g/km)
Zafira Expression					
1.6i 16v	11439.13	1715.87	13155.00	13995.00	172
Zafira Life					
1.6i 16v	13473.91	2021.09	15495.00	16335.00	172
1.6i 16v (a/c)	13900.00	2085.00	15985.00	16825.00	172
1.8i 16v VVT	14517.39	2177.61	16695.00	17535.00	177
1.8i 16v VVT Easytronic	14943.48	2241.52	17185.00	18025.00	172
2.2i 16v Direct	15460.87	2319.13	17780.00	18660.00	197
2.2i 16v Direct auto	16439.13	2465.87	18905.00	19785.00	204
<i>Diesel</i>					
1.9CDTi (120PS)	15617.39	2342.61	17960.00	18775.00	159
1.9CDTi (120PS) auto	16752.17	2512.83	19265.00	20145.00	186
Zafira Exclusiv					
1.6i 16v	12539.13	1880.87	14420.00	15260.00	172
1.8i 16v VVT	13156.52	1973.48	15130.00	15970.00	177
1.8i 16v VVT Easytronic	13582.61	2037.39	15620.00	16460.00	172
2.2i 16v Direct	14100.00	2115.00	16215.00	17095.00	197
2.2i 16v Direct auto	15078.26	2261.74	17340.00	18220.00	204
<i>Diesel</i>					
1.9CDTi (120PS)	14256.52	2138.48	16395.00	17210.00	159
1.9CDTi (120PS) auto	15391.30	2308.70	17700.00	18580.00	186

Accessory highlights

Zafira accessories

	Price (£) exc. VAT	Total (£) inc. VAT
Safety Pack • First aid kit • Warning triangle • Hi-visibility vest	21.28	24.47
Protection Pack • Velour mats (four) • Mudflaps (four) • Cargo liner	135.32	155.62

For further details of accessories and styling products see pages 54-57.

Model	Price (£)	VAT (£)	Total (£)	On-the-road RRP (£)	CO ₂ * (g/km)
Zafira Breeze (Special Edition model)					
1.6i 16v	13986.96	2098.04	16085.00	16925.00	172
1.8i 16v VVT	14604.35	2190.65	16795.00	17635.00	177
2.2i 16v Direct auto	16526.09	2478.91	19005.00	19885.00	204
<i>Diesel</i>					
1.9CDTi (120PS)	15704.35	2355.65	18060.00	18875.00	159
1.9CDTi (120PS) auto	16839.13	2525.87	19365.00	20245.00	194
Zafira Breeze Plus (Special Edition model)					
1.6i 16v	14369.57	2155.43	16525.00	17365.00	172
1.8i 16v VVT	14986.96	2248.04	17235.00	18075.00	177
2.2i 16v Direct auto	16908.70	2536.30	19445.00	20325.00	204
<i>Diesel</i>					
1.9CDTi (120PS)	16086.96	2413.04	18500.00	19315.00	159
1.9CDTi (120PS) auto	17221.74	2583.26	19805.00	20685.00	194

Please note: On-the-road recommended retail prices (RRP) include number plates and delivery to retailer of £615.00 (inc. £80.22 VAT), 12 months' Vehicle Excise Duty (see page 2) and new vehicle first registration fee of £55.00. Excludes fuel and insurance.

* = CO₂ emission figures. Vehicle Excise Duty is based on CO₂ emissions (see page 2 for details).
For benefit in kind taxation charges see page 2.

a/c = Air conditioning.

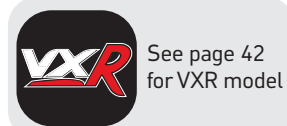

See page 42
for VXR model

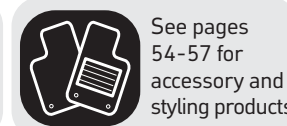

See pages
54-57 for
accessory and
styling products

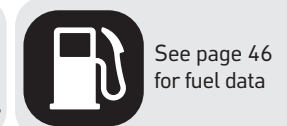

See page 46
for fuel data

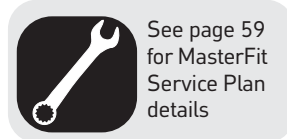

See page 59
for MasterFit
Service Plan
details

Option availability

	Expression	Life	Exclusiv	Breeze	Breeze Plus	Price (£) exc. VAT	Total (£) inc. VAT
Option packs							
VXR Styling Pack One • Body-colour lower front spoiler/rear lower skirt/rear roof spoiler and side sills			○			695.65	800.00
Seat Comfort Pack One • Driver's seat with tilt and lumbar adjustment			○			139.13	160.00
Seat Comfort Pack Two ¹ • Front passenger's seat with height, tilt and lumbar adjustment			○ ²			91.30	105.00
Panoramic Roof Pack ³ • Four glass roof panels • Roof-mounted storage console for front and rear passengers • Alloy-effect roof rails • Heat-reflective windscreen			○ ⁴			782.61	900.00
Towing Pack ⁴ • Trailer stability programme • Hill Start Assist (HSA) ⁵ ⓘ see page 53 • Deflation Detection System (DDS) ⁵ • Cruise control • Detachable tow bar			○ ⁶			300.00	345.00
FlexOrganiser® Organiser Pack • 3D storage net • Side net pocket • Four side rail hooks • Four side rails			○	○	○	43.48	50.00
Safety and security options							
Electronic Stability Programme-plus (ESP-plus) (1.6i 16v/1.8i 16v/1.9CDTi (120PS) only) ⓘ see page 53	○	○ ⁷	○ ⁷	○ ⁷	○ ⁷	386.96	445.00
Keyless entry and start ⓘ see page 51			○	○	○	269.57	310.00
Remote control ultrasonic security alarm system		○	○	○	○	204.35	235.00
Interior options							
Electronic Climate Control (ECC) ⓘ see page 52			○		●	247.83	285.00
Cruise control			○	○	○	182.61	210.00
Vertical load-restraining net		○	○	○	○	139.13	160.00
Exterior and convenience options							
Adaptive Forward Lighting (AFL) incorporating bi-xenon headlights with dynamic beam levelling and high-pressure washers ⓘ see page 52			○ ⁸			639.13	735.00
17-inch 10-spoke alloy wheels with 225/45 R 17 ultra-low profile tyres			○ ⁹			360.87	415.00
Full-size steel spare wheel (in lieu of emergency tyre inflation kit)	○	○	○	○	○	86.96	100.00
Front and rear parking distance sensors ⓘ see page 51			○	○	○	317.39	365.00
Two-coat metallic or pearlescent paint	○	○	○	○	○	343.48	395.00
Audio and communication options							
CD 30 MP3 • CD player with MP3 format • Stereo radio • Auxiliary-in socket ⓘ see page 51		○	○			65.22	75.00
CDC 40 • Integral six-disc CD autochanger with MP3 format • Stereo radio • Graphic display			○ ¹⁰			343.48	395.00
CDC 40 DAB • Integral six-disc CD autochanger with MP3 format • Stereo radio with Digital Audio Broadcast (DAB) • Graphic display			○ ¹¹	○	○	391.30	450.00
CD 70 • Satellite navigation system • CD player with MP3 format • Stereo radio • Auxiliary-in socket • Colour monitor ⓘ see page 50		○	○			1065.22	1225.00
Rear seat Twin Audio® system with single headset ¹² ⓘ see page 50			○	○	○	91.30	105.00
Mobile phone system with Bluetooth® (does not include phone or cradle) – see page 57 for details of mobile phone compatibility ⓘ see page 50		○	○	○	○	256.52	295.00

○ = Optional at extra cost. ● = Standard equipment.

1 = Deletes front passenger's underseat storage tray. **2** = Only available in conjunction with Seat Comfort Pack One. **3** = Deletes sunglasses holder. Not available in conjunction with Olympic White solid paint. **4** = Only available in conjunction with Electronic Stability Programme-plus. **5** = Not available on models fitted with automatic transmission. **6** = Requires 13-pin adaptor (available as a Vauxhall accessory). **7** = Standard on 2.2i 16v Direct model. **8** = Includes front fog lights. **9** = Includes Electronic Stability Programme-plus. **10** = Only available in conjunction with VXR Styling Pack One. Deletes auxiliary-in socket (where fitted). **11** = Not available in conjunction with VXR Styling Pack One. Deletes auxiliary-in socket (where fitted). **12** = Only available in conjunction with optional audio units. Deletes auxiliary-in socket (where fitted).



5-door MPV

Model	Price (£)	VAT (£)	Total (£)	On-the-road RRP (£)	CO ₂ * (g/km)
Zafira Design					
1.6i 16v	15530.43	2329.57	17860.00	18700.00	172
1.8i 16v VVT	16147.83	2422.17	18570.00	19410.00	177
1.8i 16v VVT Easytronic	16573.91	2486.09	19060.00	19900.00	172
2.2i 16v Direct	17304.35	2595.65	19900.00	20780.00	197
2.2i 16v Direct auto	18282.61	2742.39	21025.00	21905.00	204
2.0i 16v Turbo (200PS)	18539.13	2780.87	21320.00	22390.00	228
<i>Diesel</i>					
1.9CDTi (120PS)	17243.48	2586.52	19830.00	20645.00	159
1.9CDTi (120PS) auto	18378.26	2756.74	21135.00	22015.00	186
1.9CDTi 16v (150PS)	18204.35	2730.65	20935.00	21750.00	159
1.9CDTi 16v (150PS) auto	19339.13	2900.87	22240.00	23120.00	191
Zafira Elite					
1.8i 16v VVT	17000.00	2550.00	19550.00	20390.00	177
1.8i 16v VVT Easytronic	17426.09	2613.91	20040.00	20880.00	172
2.2i 16v Direct	18156.52	2723.48	20880.00	21760.00	197
2.2i 16v Direct auto	19134.78	2870.22	22005.00	22885.00	204
2.0i 16v Turbo (200PS)	19391.30	2908.70	22300.00	23370.00	228
<i>Diesel</i>					
1.9CDTi (120PS)	18095.65	2714.35	20810.00	21625.00	159
1.9CDTi (120PS) auto	19230.43	2884.57	22115.00	22995.00	186
1.9CDTi 16v (150PS)	19056.52	2858.48	21915.00	22730.00	159
1.9CDTi 16v (150PS) auto	20191.30	3028.70	23220.00	24100.00	191

Accessory highlights

Zafira accessories

	Price (£) exc. VAT	Total (£) inc. VAT
Safety Pack • First aid kit • Warning triangle • Hi-visibility vest	21.28	24.47
Protection Pack • Velour mats (four) • Mudflaps (four) • Cargo liner	135.32	155.62

For further details of accessories and styling products see pages 54-57.

Model	Price (£)	VAT (£)	Total (£)	On-the-road RRP (£)	CO ₂ * (g/km)
Zafira SRi					
1.8i 16v VVT	16317.39	2447.61	18765.00	19605.00	177
2.2i 16v Direct	16921.74	2538.26	19460.00	20340.00	197
2.2i 16v Direct auto	17900.00	2685.00	20585.00	21465.00	204
2.0i 16v Turbo (200PS)	18156.52	2723.48	20880.00	21950.00	228
<i>Diesel</i>					
1.9CDTi (120PS)	17413.04	2611.96	20025.00	20840.00	159
1.9CDTi (120PS) auto	18547.83	2782.17	21330.00	22210.00	186
1.9CDTi 16v (150PS)	17821.74	2673.26	20495.00	21310.00	159
1.9CDTi 16v (150PS) auto	18956.52	2843.48	21800.00	22680.00	191
Zafira SRi with Exterior Pack**					
1.8i 16v VVT	17004.35	2550.65	19555.00	20395.00	177
2.2i 16v Direct	17608.70	2641.30	20250.00	21130.00	197
2.2i 16v Direct auto	18586.96	2788.04	21375.00	22255.00	204
2.0i 16v Turbo (200PS)	18843.48	2826.52	21670.00	22740.00	228
<i>Diesel</i>					
1.9CDTi (120PS)	18100.00	2715.00	20815.00	21630.00	159
1.9CDTi (120PS) auto	19234.78	2885.22	22120.00	23000.00	186
1.9CDTi 16v (150PS)	18508.70	2776.30	21285.00	22100.00	159
1.9CDTi 16v (150PS) auto	19643.48	2946.52	22590.00	23470.00	191

Please note: On-the-road recommended retail prices (RRP) include number plates and delivery to retailer of £615.00 (inc. £80.22 VAT), 12 months' Vehicle Excise Duty (see page 2) and new vehicle first registration fee of £55.00. Excludes fuel and insurance.

* = CO₂ emission figures. Vehicle Excise Duty is based on CO₂ emissions (see page 2 for details). For benefit in kind taxation charges see page 2.

** = Exterior Pack comprises 18-inch five-spoke alloy wheels and VXR Styling Pack One (see page 27 for details).



See page 42 for VXR model



See pages 54-57 for accessory and styling products



See page 46 for fuel data



See page 59 for MasterFit Service Plan details

Option availability

	Design	Elite	SRI	Price (£) exc. VAT	Total (£) inc. VAT
Option packs					
VXR Styling Pack One • Body-colour lower front spoiler/rear lower skirt/rear roof spoiler and side sills	○	○	○ ¹	695.65	800.00
Leather Pack ² • Leather seat facings • Electrically heated sports front seats with tilt and lumbar adjustment • Driver's armrest • Front passenger's seat height adjuster		●	○	939.13	1080.00
Seat Comfort Pack Two ² • Front passenger's seat with height, tilt and lumbar adjustment	○	●	○	91.30	105.00
Panoramic Roof Pack ³ • Four glass roof panels • Roof-mounted storage console for front and rear passengers • Alloy-effect roof rails • Heat-reflective windscreen	○ ⁴	○ ⁴	○	782.61	900.00
Towing Pack ⁴ • Trailer stability programme • Hill Start Assist (HSA) ⁵ ⓘ see page 53 • Deflation Detection System (DDS) ⁵ • Cruise control • Detachable tow bar	○ ⁶	○ ⁶	○ ⁶	300.00	345.00
FlexOrganiser® Organiser Pack • 3D storage net • Side net pocket • Four side rail hooks • Four side rails	○	○	○	43.48	50.00
Safety and security options					
Electronic Stability Programme-plus (ESP-plus) (1.6i 16v/1.8i 16v/1.9CDTi (120PS) only) ⓘ see page 53	○ ⁷	○ ⁷	●	386.96	445.00
Keyless entry and start ⓘ see page 51	○	○	○	269.57	310.00
Remote control ultrasonic security alarm system	○	○	●	204.35	235.00
Interior options					
Electronic Climate Control (ECC) ⓘ see page 52		●	○	247.83	285.00
Cruise control	○	●	○	182.61	210.00
Vertical load-restraining net	○	○	○	139.13	160.00
Mechanical option					
Interactive Driving System-plus (IDS-plus) with Continuous Damping Control (CDC) ⓘ see page 53			○	369.57	425.00
Exterior and convenience options					
Electrically foldable door mirrors	○	○	○	139.13	160.00
Adaptive Forward Lighting (AFL) incorporating bi-xenon headlights with dynamic beam levelling and high-pressure washers ⓘ see page 52	○	○	○	639.13	735.00
18-inch five-spoke alloy wheels with 225/40 R 18 ultra-low profile tyres (different style to optional SRI alloy wheels)	○ ^{8,9}			304.35	350.00
18-inch five-spoke alloy wheels with 225/40 R 18 ultra-low profile tyres			○ ^{1,8}	304.35	350.00
Full-size steel spare wheel (in lieu of emergency tyre inflation kit) ¹⁰	○	○	○	86.96	100.00
Front and rear parking distance sensors ⓘ see page 51	○	○	○	317.39	365.00
Two-coat metallic or pearlescent paint	○	○	○	343.48	395.00
Audio and communication options					
CD 30 MP3 • CD player with MP3 format • Stereo radio • Auxiliary-in socket ⓘ see page 51	○	●	○	65.22	75.00
CDC 40 • Integral six-disc CD autochanger with MP3 format • Stereo radio • Graphic display	○ ¹¹	○ ¹¹	○	343.48	395.00
CDC 40 DAB • Integral six-disc CD autochanger with MP3 format • Stereo radio with Digital Audio Broadcast (DAB) • Graphic display	○ ¹²	○ ¹²		391.30	450.00
CD 70 • Satellite navigation system • CD player with MP3 format • Stereo radio • Auxiliary-in socket • Colour monitor ⓘ see page 50	○	○	○	1065.22	1225.00
Rear seat Twin Audio® system with single headset ⓘ see page 50	○ ¹³	○ ¹⁴	○ ¹³	91.30	105.00
Mobile phone system with Bluetooth® (does not include phone or cradle) – see page 57 for details of mobile phone compatibility ⓘ see page 50	○	○	○	256.52	295.00

○ = Optional at extra cost. ● = Standard equipment.

¹ = Standard on SRI with Exterior Pack models. ² = Deletes front passenger's underseat storage tray. ³ = Deletes sunglasses holder. Not available on 1.9CDTi 16v (150PS) automatic SRI with Exterior Pack models, or in conjunction with Olympic White solid paint. ⁴ = Only available in conjunction with Electronic Stability Programme-plus. ⁵ = Not available on models fitted with automatic transmission. ⁶ = Requires 13-pin adaptor (available as a Vauxhall accessory). ⁷ = Standard on 2.2i 16v Direct, 2.0i 16v Turbo and 1.9CDTi 16v (150PS) models. ⁸ = Not available on 1.9CDTi 16v (150PS) automatic model with Panoramic Roof Pack. ⁹ = Not available on 1.6i 16v, 1.8i 16v VVT and 1.9CDTi (120PS) models. ¹⁰ = Not available on 2.0i 16v Turbo models, SRI with Exterior Pack models and 18-inch alloy wheels. ¹¹ = Only available in conjunction with VXR Styling Pack One. Deletes auxiliary-in socket (where fitted). ¹² = Not available in conjunction with VXR Styling Pack One. Deletes auxiliary-in socket (where fitted). ¹³ = Only available in conjunction with optional audio units. Deletes auxiliary-in socket (where fitted). ¹⁴ = Deletes auxiliary-in socket.

5-door hatchback/4-door saloon

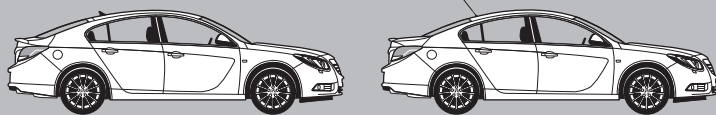

Model	Price (£)	VAT (£)	Total (£)	On-the-road RRP (£)	CO ₂ * (g/km)
Insignia Exclusiv					
1.8i 16v VVT	13739.13	2060.87	15800.00	16640.00	182
<i>Diesel</i>					
2.0CDTi 16v (130PS)	14608.70	2191.30	16800.00	17615.00	154
2.0CDTi 16v (130PS) auto	15739.13	2360.87	18100.00	18940.00	179 (177)
2.0CDTi 16v (160PS)	14826.09	2223.91	17050.00	17865.00	154
2.0CDTi 16v (160PS) auto	15956.52	2393.48	18350.00	19190.00	179 (177)
Insignia Exclusiv Nav**					
1.8i 16v VVT	14421.74	2163.26	16585.00	17425.00	182
<i>Diesel</i>					
2.0CDTi 16v (130PS)	15291.30	2293.70	17585.00	18400.00	154
2.0CDTi 16v (130PS) auto	16421.74	2463.26	18885.00	19725.00	179 (177)
2.0CDTi 16v (160PS)	15508.70	2326.30	17835.00	18650.00	154
2.0CDTi 16v (160PS) auto	16639.13	2495.87	19135.00	19975.00	179 (177)
Insignia S					
1.8i 16v VVT	14800.00	2220.00	17020.00	17860.00	182
<i>Diesel</i>					
2.0CDTi 16v (130PS)	16100.00	2415.00	18515.00	19330.00	154
2.0CDTi 16v (130PS) auto	17230.43	2584.57	19815.00	20655.00	179 (177)



See page 46 for fuel data



Car of the Year 2009

Model	Price (£)	VAT (£)	Total (£)	On-the-road RRP (£)	CO ₂ * (g/km)
Insignia SRi					
1.8i 16v VVT	15734.78	2360.22	18095.00	18935.00	182
2.0i 16v Turbo	17700.00	2655.00	20355.00	21235.00	208 (207)
2.0i 16v Turbo auto	18852.17	2827.83	21680.00	22560.00	225
2.0i 16v Turbo 4X4	18765.22	2814.78	21580.00	22460.00	215
2.0i 16v Turbo 4X4 auto	19752.17	2962.83	22715.00	23785.00	229
<i>Diesel</i>					
2.0CDTi 16v (130PS)	17034.78	2555.22	19590.00	20405.00	154
2.0CDTi 16v (130PS) auto	18165.22	2724.78	20890.00	21730.00	179 (177)
2.0CDTi 16v (160PS)	17252.17	2587.83	19840.00	20655.00	154
2.0CDTi 16v (160PS) auto	18382.61	2757.39	21140.00	21980.00	179 (177)
Insignia SRi Nav**					
1.8i 16v VVT	16417.39	2462.61	18880.00	19720.00	182
2.0i 16v Turbo	18382.61	2757.39	21140.00	22020.00	208 (207)
2.0i 16v Turbo auto	19534.78	2930.22	22465.00	23345.00	225
2.0i 16v Turbo 4X4	19447.83	2917.17	22365.00	23245.00	215
2.0i 16v Turbo 4X4 auto	20434.78	3065.22	23500.00	24570.00	229
<i>Diesel</i>					
2.0CDTi 16v (130PS)	17717.39	2657.61	20375.00	21190.00	154
2.0CDTi 16v (130PS) auto	18847.83	2827.17	21675.00	22515.00	179 (177)
2.0CDTi 16v (160PS)	17934.78	2690.22	20625.00	21440.00	154
2.0CDTi 16v (160PS) auto	19065.22	2859.78	21925.00	22765.00	179 (177)

Please note: On-the-road recommended retail prices (RRP) include number plates and delivery to retailer of £615.00 (inc. £80.22 VAT), 12 months' Vehicle Excise Duty (see page 2) and new vehicle first registration fee of £55.00. Excludes fuel and insurance.

* = CO₂ emission figures are for hatchback and saloon models. Where the figures differ between body style, the saloon figure is shown in brackets after the hatchback figure. Vehicle Excise Duty is based on CO₂ emissions (see page 2 for details). For benefit in kind taxation charges see page 2.

** = Fitted with DVD 800 Navi satellite navigation system with colour monitor/stereo radio/CD with MP3 format/auxiliary-in and USB sockets/shark fin aerial.

Option availability

	Exclusiv	Exclusiv Nav	S	SRI	SRI Nav	Price (£) exc. VAT	Total (£) inc. VAT
Option packs							
Plus Pack • 17-inch 7-spoke alloy wheels with 225/55 R 17 tyres • Front fog lights			○			369.57	425.00
Plus Pack • 18-inch 7-twinspoke alloy wheels with 245/45 R 18 tyres • Front fog lights	○	○				369.57	425.00
Sight and Light Pack • Tunnel detection for automatic lighting control • Rain-sensitive windscreen wipers • Electro-chromatic anti-dazzle rear-view mirror	○	○		○	○	173.91	200.00
Leather Pack ¹ • Perforated leather seat facings • Dual-zone electronic climate control • Driver's seat ventilation • Electrically heated front seats				○	○	1086.96	1250.00
VXR Styling Pack • Body-colour front lower spoiler/side sills/rear lower skirt/rear spoiler • Emergency tyre inflation kit	○	○		○	○	695.65	800.00
Chassis technology option							
FlexRide (Adaptive Stability Technology) system ² ⓘ see page 53				○	○	652.17	750.00
Exterior and convenience options							
Intelligent Adaptive Forward Lighting (AFL) ¹ ⓘ see page 52	○	○		○	○	739.13	850.00
Front and rear parking distance sensors	○	○	○	○	○	317.39	365.00
Cigar lighter and front ashtray	○	○	○	○	○	17.39	20.00
18-inch 5-twinspoke alloy wheels with 245/45 R 18 tyres				N/C	N/C	No-cost option	
20-inch 5-twinspoke alloy wheels with 245/35 R 20 tyres				○	○	695.65	800.00
Full-size steel spare wheel (in lieu of space-saver wheel) ³	○	○		○	○	86.96	100.00
230-volt rear power outlet	○	○	○	○	○	65.22	75.00
Two-coat metallic or pearlescent paint	○	○	○	○	○	343.48	395.00
Audio and communication options							
CDC 400 • Integral six-disc CD autochanger with MP3 format • Stereo radio with Digital Audio Broadcast (DAB) • Auxiliary-in socket • Graphic display • Seven speakers • Shark fin aerial	○		○	○		391.30	450.00
DVD 800 Navi • Satellite navigation system • CD player with MP3 format • Stereo radio • Auxiliary-in and USB sockets • Colour monitor • Shark fin aerial	○	●		○	●	1043.48	1200.00
Mobile phone system with Bluetooth® (does not include phone or cradle) and shark fin aerial	○	○	○	○	○	130.43	150.00

○ = Optional at extra cost. ● = Standard equipment. N/C = No-cost option.

¹ = Sight and Light Pack is also included. ² = Standard on 2.0i 16v Turbo models. Not available on 1.8i 16v VVT models. ³ = Not available with 20-inch wheels, or in conjunction with VXR Styling Pack. Fitment of full-size spare wheel reduces luggage capacities.

5-door hatchback/4-door saloon

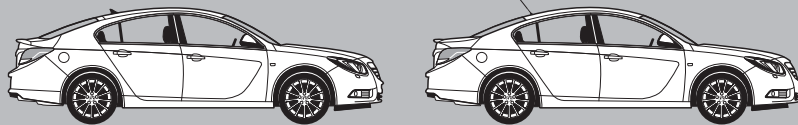

Model	Price (£)	VAT (£)	Total (£)	On-the-road RRP (£)	CO ₂ * (g/km)
Insignia SE					
1.8i 16v VVT	16334.78	2450.22	18785.00	19625.00	182
2.0i 16v Turbo	18300.00	2745.00	21045.00	21925.00	208 (207)
2.0i 16v Turbo auto	19452.17	2917.83	22370.00	23250.00	225
2.0i 16v Turbo 4X4	19365.22	2904.78	22270.00	23150.00	215
2.0i 16v Turbo 4X4 auto	20352.17	3052.83	23405.00	24475.00	229
<i>Diesel</i>					
2.0CDTi 16v (130PS)	17630.43	2644.57	20275.00	21090.00	154
2.0CDTi 16v (130PS) auto	18760.87	2814.13	21575.00	22415.00	179 (177)
2.0CDTi 16v (160PS)	17847.83	2677.17	20525.00	21340.00	154
2.0CDTi 16v (160PS) auto	18978.26	2846.74	21825.00	22665.00	179 (177)
Insignia SE Nav**					
1.8i 16v VVT	17017.39	2552.61	19570.00	20410.00	182
2.0i 16v Turbo	18982.61	2847.39	21830.00	22710.00	208 (207)
2.0i 16v Turbo auto	20134.78	3020.22	23155.00	24035.00	225
2.0i 16v Turbo 4X4	20047.83	3007.17	23055.00	23935.00	215
2.0i 16v Turbo 4X4 auto	21034.78	3155.22	24190.00	25260.00	229
<i>Diesel</i>					
2.0CDTi 16v (130PS)	18313.04	2746.96	21060.00	21875.00	154
2.0CDTi 16v (130PS) auto	19443.48	2916.52	22360.00	23200.00	179 (177)
2.0CDTi 16v (160PS)	18530.43	2779.57	21310.00	22125.00	154
2.0CDTi 16v (160PS) auto	19660.87	2949.13	22610.00	23450.00	179 (177)



See page 46 for fuel data

Car of the Year 2009



Model	Price (£)	VAT (£)	Total (£)	On-the-road RRP (£)	CO ₂ * (g/km)
Insignia Elite					
1.8i 16v VVT	18034.78	2705.22	20740.00	21580.00	182
2.0i 16v Turbo	20000.00	3000.00	23000.00	23880.00	208 (207)
2.0i 16v Turbo auto	21152.17	3172.83	24325.00	25205.00	225
2.0i 16v Turbo 4X4	21065.22	3159.78	24225.00	25105.00	215
2.0i 16v Turbo 4X4 auto	22052.17	3307.83	25360.00	26430.00	229
2.8i V6 24v Turbo 4X4 auto	23882.61	3582.39	27465.00	28535.00	272
<i>Diesel</i>					
2.0CDTi 16v (160PS)	19547.83	2932.17	22480.00	23295.00	154
2.0CDTi 16v (160PS) auto	20678.26	3101.74	23780.00	24620.00	179 (177)
Insignia Elite Nav**					
1.8i 16v VVT	18717.39	2807.61	21525.00	22365.00	182
2.0i 16v Turbo	20682.61	3102.39	23785.00	24665.00	208 (207)
2.0i 16v Turbo auto	21834.78	3275.22	25110.00	25990.00	225
2.0i 16v Turbo 4X4	21747.83	3262.17	25010.00	25890.00	215
2.0i 16v Turbo 4X4 auto	22734.78	3410.22	26145.00	27215.00	229
2.8i V6 24v Turbo 4X4 auto	24565.22	3684.78	28250.00	29320.00	272
<i>Diesel</i>					
2.0CDTi 16v (160PS)	20230.43	3034.57	23265.00	24080.00	154
2.0CDTi 16v (160PS) auto	21360.87	3204.13	24565.00	25405.00	179 (177)

Please note: On-the-road recommended retail prices (RRP) include number plates and delivery to retailer of £615.00 (inc. £80.22 VAT), 12 months' Vehicle Excise Duty (see page 2) and new vehicle first registration fee of £55.00. Excludes fuel and insurance.

* = CO₂ emission figures are for hatchback and saloon models. Where the figures differ between body style, the saloon figure is shown in brackets after the hatchback figure. Vehicle Excise Duty is based on CO₂ emissions (see page 2 for details). For benefit in kind taxation charges see page 2.

** = Fitted with DVD 800 Navi satellite navigation system with colour monitor/stereo radio/CD with MP3 format/auxiliary-in and USB sockets/shark fin aerial/multi-function infotainment controller.

Option availability

	SE	SE Nav	Elite	Elite Nav	Price (£) exc. VAT	Total (£) inc. VAT
Option packs						
Plus Pack • 19-inch 10-spoke alloy wheels with 245/40 R 19 tyres • Front fog lights	○	○			413.04	475.00
VXR Styling Pack • Body-colour front lower spoiler/side sills/rear lower skirt/rear spoiler • Emergency tyre inflation kit	○	○	○	○	695.65	800.00
Chassis technology option						
FlexRide (Adaptive Stability Technology) system ¹ ⓘ see page 53	○ ²	○ ²	○ ³	○ ³	652.17	750.00
Exterior and convenience options						
Intelligent Adaptive Forward Lighting (AFL) ⓘ see page 52	○	○	●	●	739.13	850.00
Front camera system	○ ⁴	○ ⁴	○ ⁵	○ ⁵	430.43	495.00
Front and rear parking distance sensors	○	○	●	●	317.39	365.00
Rear side window sunblinds	○	○	○	○	173.91	200.00
Cigar lighter and front ashtray	○	○	○	○	17.39	20.00
18-inch 13-spoke alloy wheels with 245/45 R 18 tyres	N/C	N/C	●	●	No-cost option	
19-inch 10-spoke alloy wheels with 245/40 R 19 tyres			○	○	347.83	400.00
Full-size steel spare wheel (in lieu of space-saver wheel) ⁶	○	○	○	○	86.96	100.00
230-volt rear power outlet	○	○	○	○	65.22	75.00
Front fog lights	○	○	●	●	130.43	150.00
Two-coat metallic or pearlescent paint	○	○	○	○	343.48	395.00
Audio and communication options						
DVD 800 Navi • Satellite navigation system • CD player with MP3 format • Stereo radio • Auxiliary-in and USB sockets • Colour monitor • Multi-function infotainment controller • Shark fin aerial	○	●	○	●	782.61	900.00
Mobile phone system with Bluetooth® (does not include phone or cradle) and shark fin aerial	○	○	○	○	130.43	150.00

○ = Optional at extra cost. ● = Standard equipment. N/C = No-cost option.

¹ = Standard on 2.0i 16v Turbo models. Not available on 1.8i 16v VVT models. ² = Not available on 2.0CDTi 16v (130PS) models. ³ = Standard on 2.8i V6 24v Turbo models. ⁴ = Deletes high beam with assist function from optional Intelligent Adaptive Forward Lighting (AFL). ⁵ = Deletes high beam with assist function. ⁶ = Not available with 19-inch wheels, or in conjunction with VXR Styling Pack. Fitment of full-size spare wheel reduces luggage capacities.



Sports Tourer

Car of the Year 2009



Model	Price (£)	VAT (£)	Total (£)	On-the-road RRP (£)	CO ₂ * (g/km)
Insignia Exclusiv					
1.8i 16v VVT	14769.57	2215.43	16985.00	17865.00	187
<i>Diesel</i>					
2.0CDTi 16v (130PS)	15673.91	2351.09	18025.00	18840.00	159
2.0CDTi 16v (130PS) auto	16804.35	2520.65	19325.00	20165.00	182
2.0CDTi 16v (160PS)	15891.30	2383.70	18275.00	19090.00	159
2.0CDTi 16v (160PS) auto	17021.74	2553.26	19575.00	20415.00	182
Insignia Exclusiv Nav**					
1.8i 16v VVT	15452.17	2317.83	17770.00	18650.00	187
<i>Diesel</i>					
2.0CDTi 16v (130PS)	16356.52	2453.48	18810.00	19625.00	159
2.0CDTi 16v (130PS) auto	17486.96	2623.04	20110.00	20950.00	182
2.0CDTi 16v (160PS)	16573.91	2486.09	19060.00	19875.00	159
2.0CDTi 16v (160PS) auto	17704.35	2655.65	20360.00	21200.00	182
Insignia S					
1.8i 16v VVT	15830.43	2374.57	18205.00	19085.00	187
<i>Diesel</i>					
2.0CDTi 16v (130PS)	17165.22	2574.78	19740.00	20555.00	159
2.0CDTi 16v (130PS) auto	18295.65	2744.35	21040.00	21880.00	182



See page 47 for fuel data

Model	Price (£)	VAT (£)	Total (£)	On-the-road RRP (£)	CO ₂ * (g/km)
Insignia SRi					
1.8i 16v VVT	16765.22	2514.78	19280.00	20160.00	187
2.0i 16v Turbo	18765.22	2814.78	21580.00	22460.00	209
2.0i 16v Turbo auto	19752.17	2962.83	22715.00	23785.00	228
2.0i 16v Turbo 4X4	19830.43	2974.57	22805.00	23685.00	219
2.0i 16v Turbo 4X4 auto	20817.39	3122.61	23940.00	25010.00	233
<i>Diesel</i>					
2.0CDTi 16v (130PS)	18100.00	2715.00	20815.00	21630.00	159
2.0CDTi 16v (130PS) auto	19230.43	2884.57	22115.00	22955.00	182
2.0CDTi 16v (160PS)	18317.39	2747.61	21065.00	21880.00	159
2.0CDTi 16v (160PS) auto	19447.83	2917.17	22365.00	23205.00	182
Insignia SRi Nav**					
1.8i 16v VVT	17447.83	2617.17	20065.00	20945.00	187
2.0i 16v Turbo	19447.83	2917.17	22365.00	23245.00	209
2.0i 16v Turbo auto	20434.78	3065.22	23500.00	24570.00	228
2.0i 16v Turbo 4X4	20513.04	3076.96	23590.00	24470.00	219
2.0i 16v Turbo 4X4 auto	21500.00	3225.00	24725.00	25795.00	233
<i>Diesel</i>					
2.0CDTi 16v (130PS)	18782.61	2817.39	21600.00	22415.00	159
2.0CDTi 16v (130PS) auto	19913.04	2986.96	22900.00	23740.00	182
2.0CDTi 16v (160PS)	19000.00	2850.00	21850.00	22665.00	159
2.0CDTi 16v (160PS) auto	20130.43	3019.57	23150.00	23990.00	182

Please note: On-the-road recommended retail prices (RRP) include number plates and delivery to retailer of £615.00 (inc. £80.22 VAT), 12 months' Vehicle Excise Duty (see page 2) and new vehicle first registration fee of £55.00. Excludes fuel and insurance.

* = Provisional CO₂ emission figures. Vehicle Excise Duty is based on CO₂ emissions (see page 2 for details). For benefit in kind taxation charges see page 2.

** = Fitted with DVD 800 Navi satellite navigation system with colour monitor/stereo radio/CD with MP3 format/auxiliary-in and USB sockets/shark fin aerial.

Option availability

	Exclusiv	Exclusiv Nav	S	SRI	SRI Nav	Price (£) exc. VAT	Total (£) inc. VAT
Option packs							
Plus Pack • 17-inch 7-spoke alloy wheels with 225/55 R 17 tyres • Front fog lights			○			369.57	425.00
Plus Pack • 18-inch 7-twin spoke alloy wheels with 245/45 R 18 tyres • Front fog lights	○	○				369.57	425.00
Sight and Light Pack • Tunnel detection for automatic lighting control • Rain-sensitive windscreen wipers • Electro-chromatic anti-dazzle rear-view mirror	○	○		○	○	173.91	200.00
Leather Pack ¹ • Perforated leather seat facings • Dual-zone electronic climate control • Driver's seat ventilation • Electrically heated front seats				○	○	1086.96	1250.00
VXR Styling Pack • Body-colour front lower spoiler/side sills/rear lower skirt/rear spoiler • Emergency tyre inflation kit	○	○		○	○	695.65	800.00
Towing Pack • Trailer stability programme • Automatic self-levelling rear suspension • Retractable tow bar	○	○				491.30	565.00
FlexOrganiser® Pack • Four side rails • 3D storage net • Side net pocket • Four side rail hooks	○	○	○	○	○	86.96	100.00
Chassis technology option							
FlexRide (Adaptive Stability Technology) system ² ⓘ see page 53				○	○	652.17	750.00
Exterior and convenience options							
Intelligent Adaptive Forward Lighting (AFL) ¹ ⓘ see page 52	○	○		○	○	739.13	850.00
Front and rear parking distance sensors	○	○	○	○	○	317.39	365.00
Cigar lighter and front ashtray	○	○	○	○	○	17.39	20.00
18-inch 5-twin spoke alloy wheels with 245/45 R 18 tyres				N/C	N/C	No-cost option	
20-inch 5-twin spoke alloy wheels with 245/35 R 20 tyres				○	○	695.65	800.00
Full-size steel spare wheel (in lieu of space-saver wheel) ³	○	○		○	○	86.96	100.00
Vertical load-restraining net	○	○	○	○	○	173.91	200.00
230-volt rear power outlet	○	○	○	○	○	65.22	75.00
Two-coat metallic or pearlescent paint	○	○	○	○	○	343.48	395.00
Audio and communication options							
CDC 400 • Integral six-disc CD autochanger with MP3 format • Stereo radio with Digital Audio Broadcast (DAB) • Auxiliary-in socket • Graphic display • Seven speakers • Shark fin aerial	○		○	○		391.30	450.00
DVD 800 Navi • Satellite navigation system • CD player with MP3 format • Stereo radio • Auxiliary-in and USB sockets • Colour monitor • Shark fin aerial	○	●		○	●	1043.48	1200.00
Mobile phone system with Bluetooth® (does not include phone or cradle) and shark fin aerial	○	○	○	○	○	130.43	150.00

○ = Optional at extra cost. ● = Standard equipment. N/C = No-cost option.

¹ = Sight and Light Pack is also included. ² = Standard on 2.0i 16v Turbo models. Not available on 1.8i 16v VVT models. ³ = Not available with 20-inch wheels, or in conjunction with VXR Styling Pack. Fitment of full-size spare wheel reduces luggage capacities.

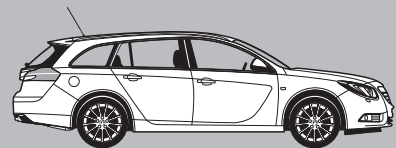

Sports Tourer

Model	Price (£)	VAT (£)	Total (£)	On-the-road RRP (£)	CO ₂ * (g/km)
Insignia SE					
1.8i 16v VVT	17491.30	2623.70	20115.00	20995.00	187
2.0i 16v Turbo	19491.30	2923.70	22415.00	23295.00	209
2.0i 16v Turbo auto	20478.26	3071.74	23550.00	24620.00	228
2.0i 16v Turbo 4X4	20556.52	3083.48	23640.00	24520.00	219
2.0i 16v Turbo 4X4 auto	21543.48	3231.52	24775.00	25845.00	233
<i>Diesel</i>					
2.0CDTi 16v (130PS)	18821.74	2823.26	21645.00	22460.00	159
2.0CDTi 16v (130PS) auto	19952.17	2992.83	22945.00	23785.00	182
2.0CDTi 16v (160PS)	19039.13	2855.87	21895.00	22710.00	159
2.0CDTi 16v (160PS) auto	20169.57	3025.43	23195.00	24035.00	182
Insignia SE Nav**					
1.8i 16v VVT	18173.91	2726.09	20900.00	21780.00	187
2.0i 16v Turbo	20173.91	3026.09	23200.00	24080.00	209
2.0i 16v Turbo auto	21160.87	3174.13	24335.00	25405.00	228
2.0i 16v Turbo 4X4	21239.13	3185.87	24425.00	25305.00	219
2.0i 16v Turbo 4X4 auto	22226.09	3333.91	25560.00	26630.00	233
<i>Diesel</i>					
2.0CDTi 16v (130PS)	19504.35	2925.65	22430.00	23245.00	159
2.0CDTi 16v (130PS) auto	20634.78	3095.22	23730.00	24570.00	182
2.0CDTi 16v (160PS)	19721.74	2958.26	22680.00	23495.00	159
2.0CDTi 16v (160PS) auto	20852.17	3127.83	23980.00	24820.00	182

 See page 47
for fuel data

Car of the Year 2009



Model	Price (£)	VAT (£)	Total (£)	On-the-road RRP (£)	CO ₂ * (g/km)
Insignia Elite					
1.8i 16v VVT	19191.30	2878.70	22070.00	22950.00	187
2.0i 16v Turbo	21191.30	3178.70	24370.00	25250.00	209
2.0i 16v Turbo auto	22178.26	3326.74	25505.00	26575.00	228
2.0i 16v Turbo 4X4	22256.52	3338.48	25595.00	26475.00	219
2.0i 16v Turbo 4X4 auto	23243.48	3486.52	26730.00	27800.00	233
2.8i V6 24v Turbo 4X4 auto	25073.91	3761.09	28835.00	29905.00	277
<i>Diesel</i>					
2.0CDTi 16v (160PS)	20739.13	3110.87	23850.00	24665.00	159
2.0CDTi 16v (160PS) auto	21869.57	3280.43	25150.00	25990.00	182
Insignia Elite Nav**					
1.8i 16v VVT	19873.91	2981.09	22855.00	23735.00	187
2.0i 16v Turbo	21873.91	3281.09	25155.00	26035.00	209
2.0i 16v Turbo auto	22860.87	3429.13	26290.00	27360.00	228
2.0i 16v Turbo 4X4	22939.13	3440.87	26380.00	27260.00	219
2.0i 16v Turbo 4X4 auto	23926.09	3588.91	27515.00	28585.00	233
2.8i V6 24v Turbo 4X4 auto	25756.52	3863.48	29620.00	30690.00	277
<i>Diesel</i>					
2.0CDTi 16v (160PS)	21421.74	3213.26	24635.00	25450.00	159
2.0CDTi 16v (160PS) auto	22552.17	3382.83	25935.00	26775.00	182

Please note: On-the-road recommended retail prices (RRP) include number plates and delivery to retailer of £615.00 (inc. £80.22 VAT), 12 months' Vehicle Excise Duty (see page 2) and new vehicle first registration fee of £55.00. Excludes fuel and insurance.

* = Provisional CO₂ emission figures. Vehicle Excise Duty is based on CO₂ emissions (see page 2 for details). For benefit in kind taxation charges see page 2.

** = Fitted with DVD 800 Navi satellite navigation system with colour monitor/stereo radio/CD with MP3 format/auxiliary-in and USB sockets/shark fin aerial/multi-function infotainment controller.

Option availability

	SE	SE Nav	Elite	Elite Nav	Price (£) exc. VAT	Total (£) inc. VAT
Option packs						
Plus Pack • 19-inch 10-spoke alloy wheels with 245/40 R 19 tyres • Front fog lights	○	○			413.04	475.00
VXR Styling Pack • Body-colour front lower spoiler/side sills/rear lower skirt/rear spoiler • Emergency tyre inflation kit	○	○	○	○	695.65	800.00
Towing Pack • Trailer stability programme • Automatic self-levelling rear suspension • Retractable tow bar	○ ¹	○ ¹	○ ²	○ ²	491.30	565.00
FlexOrganiser® Pack • Four side rails • 3D storage net • Side net pocket • Four side rail hooks	○	○	○	○	86.96	100.00
Chassis technology option						
FlexRide (Adaptive Stability Technology) system ³ ⓘ see page 53	○ ⁴	○ ⁴	○ ⁵	○ ⁵	652.17	750.00
Exterior and convenience options						
Intelligent Adaptive Forward Lighting (AFL) ⓘ see page 52	○	○	●	●	739.13	850.00
Front camera system	○ ⁶	○ ⁶	○ ⁷	○ ⁷	430.43	495.00
Front and rear parking distance sensors	○	○	●	●	317.39	365.00
Rear side window sunblinds	○	○	○	○	173.91	200.00
Cigar lighter and front ashtray	○	○	○	○	17.39	20.00
18-inch 13-spoke alloy wheels with 245/45 R 18 tyres	N/C	N/C	●	●	No-cost option	
19-inch 10-spoke alloy wheels with 245/40 R 19 tyres			○	○	347.83	400.00
Full-size steel spare wheel (in lieu of space-saver wheel) ⁸	○	○	○	○	86.96	100.00
Vertical load-restraining net	○	○	○	○	173.91	200.00
230-volt rear power outlet	○	○	○	○	65.22	75.00
Front fog lights	○	○	●	●	130.43	150.00
Two-coat metallic or pearlescent paint	○	○	○	○	343.48	395.00
Audio and communication options						
DVD 800 Navi • Satellite navigation system • CD player with MP3 format • Stereo radio • Auxiliary-in and USB sockets • Colour monitor • Multi-function infotainment controller • Shark fin aerial	○	●	○	●	782.61	900.00
Mobile phone system with Bluetooth® (does not include phone or cradle) and shark fin aerial	○	○	○	○	130.43	150.00

○ = Optional at extra cost. ● = Standard equipment. N/C = No-cost option.

¹ = Not available on 2.0i 16v Turbo models, or in conjunction with optional FlexRide system. ² = Not available on 2.0i 16v Turbo or 2.8i V6 24v Turbo models, or in conjunction with optional FlexRide system. ³ = Standard on 2.0i 16v Turbo models. Not available on 1.8i 16v VVT models. ⁴ = Not available on 2.0CDTi 16v (130PS) models. ⁵ = Standard on 2.8i V6 24v Turbo models. ⁶ = Deletes high beam with assist function from optional Intelligent Adaptive Forward Lighting (AFL).

⁷ = Deletes high beam with assist function. ⁸ = Not available with 19-inch wheels, or in conjunction with VXR Styling Pack. Fitment of full-size spare wheel reduces luggage capacities.

5-door hatchback

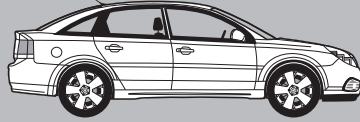

Model	Price (£)	VAT (£)	Total (£)	On-the-road RRP (£)	CO ₂ * (g/km)
Vectra Life					
1.8i 16v VVT	13891.30	2083.70	15975.00	16815.00	173
Vectra Exclusiv					
1.8i 16v VVT	12830.43	1924.57	14755.00	15595.00	173
<i>Diesel</i>					
1.9CDTi (120PS)	13700.00	2055.00	15755.00	16570.00	154
1.9CDTi 16v (150PS)	14126.09	2118.91	16245.00	17060.00	154
Vectra Exclusiv Nav**					
<i>Diesel</i>					
1.9CDTi (120PS)	14339.13	2150.87	16490.00	17305.00	154
Vectra Design					
1.8i 16v VVT	15426.09	2313.91	17740.00	18580.00	173
<i>Diesel</i>					
1.9CDTi (120PS)	16721.74	2508.26	19230.00	20045.00	154
1.9CDTi 16v (150PS) auto	18552.17	2782.83	21335.00	22215.00	186
Vectra Elite Nav†					
<i>Diesel</i>					
1.9CDTi 16v (150PS)	19160.87	2874.13	22035.00	22850.00	154
1.9CDTi 16v (150PS) auto	20565.22	3084.78	23650.00	24530.00	186
3.0CDTi V6 24v auto	22821.74	3423.26	26245.00	27125.00	192

Model	Price (£)	VAT (£)	Total (£)	On-the-road RRP (£)	CO ₂ * (g/km)
Vectra SRi					
1.8i 16v VVT	14830.43	2224.57	17055.00	17895.00	173
2.2i 16v Direct	15339.13	2300.87	17640.00	18480.00	180
<i>Diesel</i>					
1.9CDTi (120PS)	16126.09	2418.91	18545.00	19360.00	154
1.9CDTi 16v (150PS)	16552.17	2482.83	19035.00	19850.00	154
1.9CDTi 16v (150PS) auto	17956.52	2693.48	20650.00	21530.00	186
Vectra SRi Nav†					
1.8i 16v VVT	15504.35	2325.65	17830.00	18670.00	173
<i>Diesel</i>					
1.9CDTi 16v (150PS)	17226.09	2583.91	19810.00	20625.00	154
Vectra SRi Nav† with Exterior Pack††					
<i>Diesel</i>					
1.9CDTi 16v (150PS)	18000.00	2700.00	20700.00	21515.00	154

Please note: On-the-road recommended retail prices (RRP) include number plates and delivery to retailer of £615.00 (inc. £80.22 VAT), 12 months' Vehicle Excise Duty (see page 2) and new vehicle first registration fee of £55.00. Excludes fuel and insurance.

* = CO₂ emission figures. Vehicle Excise Duty is based on CO₂ emissions (see page 2 for details). For benefit in kind taxation charges see page 2.

** = Fitted with satellite navigation with monochromatic display/CD player with MP3 format/ auxiliary-in socket/stereo radio (CD 70).

† = Fitted with satellite navigation with colour monitor/CD player with MP3 format/ auxiliary-in socket/stereo radio (CD 70).

†† = Exterior Pack comprises 18-inch multi-spoke alloy wheels, body-colour sports front bumper/ air dam/side sills/rear lower skirt/rear spoiler, VXR-style leather-covered sports steering wheel and VXR-style leather-covered gear knob (excluding 1.8i 16v VVT and auto models).

Option availability: Please note Vectra models are only available from stock. Some models may be fitted with options at extra cost. Please check with your retailer for availability and prices.

5-door estate

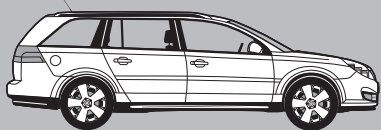

Model	Price (£)	VAT (£)	Total (£)	On-the-road RRP (£)	CO ₂ * (g/km)
Vectra Life					
1.8i 16v VVT	14830.43	2224.57	17055.00	17895.00	180
<i>Diesel</i>					
1.9CDTi (120PS)	16426.09	2463.91	18890.00	19705.00	157
Vectra Exclusiv					
<i>Diesel</i>					
1.9CDTi (120PS)	14934.78	2240.22	17175.00	17990.00	157
1.9CDTi 16v (150PS)	15360.87	2304.13	17665.00	18480.00	157
Vectra Design					
<i>Diesel</i>					
1.9CDTi (120PS)	17956.52	2693.48	20650.00	21465.00	157
1.9CDTi 16v (150PS)	18382.61	2757.39	21140.00	21955.00	157
Vectra Elite Nav†					
<i>Diesel</i>					
1.9CDTi 16v (150PS)	20395.65	3059.35	23455.00	24270.00	157
1.9CDTi 16v (150PS) auto	21500.00	3225.00	24725.00	25605.00	189

Model	Price (£)	VAT (£)	Total (£)	On-the-road RRP (£)	CO ₂ * (g/km)
Vectra SRi					
1.8i 16v VVT	15765.22	2364.78	18130.00	18970.00	180
<i>Diesel</i>					
1.9CDTi (120PS)	17360.87	2604.13	19965.00	20780.00	157
1.9CDTi 16v (150PS)	17786.96	2668.04	20455.00	21270.00	157
Vectra SRi Nav†					
<i>Diesel</i>					
1.9CDTi 16v (150PS)	18460.87	2769.13	21230.00	22045.00	157

Please note: On-the-road recommended retail prices (RRP) include number plates and delivery to retailer of £615.00 (inc. £80.22 VAT), 12 months' Vehicle Excise Duty (see page 2) and new vehicle first registration fee of £55.00. Excludes fuel and insurance.

* = CO₂ emission figures. Vehicle Excise Duty is based on CO₂ emissions (see page 2 for details). For benefit in kind taxation charges see page 2.

† = Fitted with satellite navigation with colour monitor/CD player with MP3 format/auxiliary-in socket/stereo radio (CD 70).

Option availability: Please note Vectra models are only available from stock. Some models may be fitted with options at extra cost. Please check with your retailer for availability and prices.



See page 43 for VXR model



See pages 46-47 for fuel data



See page 59 for MasterFit Service Plan details

Accessory highlights

Astra accessories

	Price (£) exc. VAT	Total (£) inc. VAT
Safety Pack		
• First aid kit • Warning triangle • Hi-visibility vest	21.28	24.47
Protection Pack		
• Velour mats (four) • Mudflaps (four) • Cargo liner	135.32	155.62

For further details of accessories and styling products see pages 54-57.



5-door SUV

Model	Price (£)	VAT (£)	Total (£)	On-the-road RRP (£)	CO ₂ * (g/km)
Antara E					
<i>Diesel</i>					
2.0CDTi 16v	17230.43	2584.57	19815.00	20695.00	198
2.0CDTi 16v auto	18404.35	2760.65	21165.00	22045.00	225
Antara S					
<i>Diesel</i>					
2.0CDTi 16v	18526.09	2778.91	21305.00	22185.00	198
2.0CDTi 16v auto	19700.00	2955.00	22655.00	23535.00	225
Antara SE					
<i>Diesel</i>					
2.0CDTi 16v	21673.91	3251.09	24925.00	25805.00	198
2.0CDTi 16v auto	22847.83	3427.17	26275.00	27155.00	225

Please note: On-the-road recommended retail prices (RRP) include number plates and delivery to retailer of £615.00 (inc. £80.22 VAT), 12 months' Vehicle Excise Duty (see page 2) and new vehicle first registration fee of £55.00. Excludes fuel and insurance.

* = CO₂ emission figure. Vehicle Excise Duty is based on CO₂ emissions (see page 2 for details). For benefit in kind taxation charges see page 2.



See pages 54-57 for accessory and styling products



See page 47 for fuel data



See page 59 for MasterFit Service Plan details

Option availability

	Antara E	Antara S	Antara SE	Price (£) exc. VAT	Total (£) inc. VAT
Exterior options					
Front and rear parking distance sensors ¹		○	●	317.39	365.00
Two-coat metallic or pearlescent paint	○	○	○	369.57	425.00

○ = Optional at extra cost. ● = Standard equipment.

¹ = Restricted option availability, please consult your retailer for details.

Accessory highlights

Antara accessories

	Price (£) exc. VAT	Total (£) inc. VAT
Safety Pack • First aid kit • Warning triangle • Hi-visibility vest	21.28	24.47
Protection Pack • Velour mats (four) • Mudflaps (four) • Cargo liner	135.32	155.62

For further details of accessories and styling products see pages 54-57.

3-door hatchback

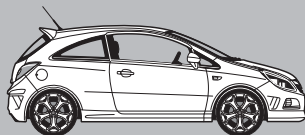

Model	Price (£)	VAT (£)	Total (£)	On-the-road RRP (£)	CO ₂ * (g/km)
Corsa VXR					
1.6i 16v Turbo (192PS)	13543.48	2031.52	15575.00	16455.00	190
Corsa VXR Arctic Edition					
1.6i 16v Turbo (192PS)	14213.04	2131.96	16345.00	17225.00	190

Please note: On-the-road recommended retail prices (RRP) include number plates and delivery to retailer of £615.00 (inc. £80.22 VAT), 12 months' Vehicle Excise Duty (see page 2) and new vehicle first registration fee of £55.00. Excludes fuel and insurance.

* = CO₂ emission figure. Vehicle Excise Duty is based on CO₂ emissions (see page 2 for details). For benefit in kind taxation charges see page 2.



See pages 54-57 for accessory and styling products



See page 47 for fuel data



See page 59 for MasterFit Service Plan details

Option availability

	VXR	Arctic	Price (£) exc. VAT	Total (£) inc. VAT
Option packs				
Leather Pack • Leather seat facings • Electrically heated Recaro shell-backed sports front seats	<input type="radio"/>	<input type="radio"/>	865.22	995.00
Sight and Light Pack • Rain-sensitive windshield wipers • Electro-chromatic anti-dazzle rear-view mirror • Automatic lighting control	<input type="radio"/>	<input type="radio"/>	173.91	200.00
Interior option				
Electronic Climate Control (ECC) incorporating air conditioning 1 see page 52	<input type="radio"/>	<input type="radio"/>	247.83	285.00
Mechanical option				
Remus stainless steel 65mm sports exhaust system, incorporating front de-cat downpipe and rear silencer – retailer-fit (excluding fitting) 1 see below for ordering details	<input type="radio"/>	<input checked="" type="radio"/>	369.57	425.00
Exterior and convenience options				
18-inch V-spoke alloy wheels with anthracite inner, 225/35 R 18 ultra-low profile tyres	<input type="radio"/>	<input type="radio"/>	426.09	490.00
Adaptive Forward Lighting (AFL) – halogen 1 see page 52	<input type="radio"/>	<input type="radio"/>	226.09	260.00
Dark-tinted windows (excludes windshield and front door windows)	<input type="radio"/>	<input checked="" type="radio"/>	226.09	260.00
Rear parking distance sensors 1 see page 51	<input type="radio"/>	<input type="radio"/>	226.09	260.00
Two-coat metallic or pearlescent paint	<input type="radio"/>	<input type="radio"/>	343.48	395.00
Audio and communication options				
CDC 40 • Integral six-disc CD autochanger with MP3 format • Stereo radio • Graphic display ¹	<input type="radio"/>	<input type="radio"/>	343.48	395.00
CD 60 • Satellite navigation system • CD player with MP3 format • Stereo radio • Auxiliary-in socket • Graphic display	<input type="radio"/>	<input type="radio"/>	830.43	955.00
Mobile phone system with Bluetooth® (does not include phone or cradle) – see page 57 for details of mobile phone compatibility 1 see page 50	<input type="radio"/>	<input type="radio"/>	256.52	295.00

○ = Optional at extra cost. ● = Standard equipment. 1 = Deletes auxiliary-in socket.



Performance Centre

Vauxhall has teamed up with Triple Eight Race Engineering to make genuine VXR-style performance available to every Vauxhall owner. Located at VXRacing's BTCC team headquarters, the new VXR Performance Centre offers proven engine, brake, suspension and body styling upgrades. For more details, visit www.vxrperformance.co.uk, telephone 01295 768880 or contact your local Vauxhall retailer.





5-door MPV

Model	Price (£)	VAT (£)	Total (£)	On-the-road RRP (£)	CO ₂ * (g/km)
Meriva VXR					
1.6i 16v Turbo (180PS)	14200.00	2130.00	16330.00	17210.00	187

Please note: On-the-road recommended retail prices (RRP) include number plates and delivery to retailer of £615.00 (inc. £80.22 VAT), 12 months' Vehicle Excise Duty (see page 2) and new vehicle first registration fee of £55.00. Excludes fuel and insurance.

* = CO₂ emission figure. Vehicle Excise Duty is based on CO₂ emissions (see page 2 for details). For benefit in kind taxation charges see page 2.



See pages 54-57 for accessory and styling products



See page 47 for fuel data



See page 59 for MasterFit Service Plan details

Option availability

	VXR	Price (£) exc. VAT	Total (£) inc. VAT
Option pack			
Leather Pack • Leather seat facings • Electrically heated Recaro sports front seats	<input type="radio"/>	852.17	980.00
Exterior and convenience options			
Adaptive Forward Lighting (AFL) – halogen 1 see page 52	<input type="radio"/>	226.09	260.00
Two-coat metallic or pearlescent paint	<input type="radio"/>	343.48	395.00
Audio and communication options			
CDC 40 • Integral six-disc CD autochanger with MP3 format • Stereo radio • Graphic display ¹	<input type="radio"/>	386.96	445.00
CD 70 • Satellite navigation system • CD player with MP3 format • Stereo radio • Auxiliary-in socket • Graphic display 1 see page 50	<input type="radio"/>	830.43	955.00
Rear seat Twin Audio® system with single headset 1 see page 50	<input type="radio"/>	91.30	105.00
Mobile phone system with Bluetooth® (does not include phone or cradle) – see page 57 for details of mobile phone compatibility 1 see page 50	<input type="radio"/>	256.52	295.00

○ = Optional at extra cost.

1 = Deletes auxiliary-in socket. **2** = Not available in conjunction with mobile phone system with Bluetooth®. Deletes auxiliary-in socket.

3-door hatchback

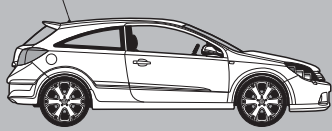

Model	Price (£)	VAT (£)	Total (£)	On-the-road RRP (£)	CO ₂ * (g/km)
Astra VXR					
2.0i 16v Turbo (240PS)	16952.17	2542.83	19495.00	20375.00	221

Please note: On-the-road recommended retail prices (RRP) include number plates and delivery to retailer of £615.00 (inc. £80.22 VAT), 12 months' Vehicle Excise Duty (see page 2) and new vehicle first registration fee of £55.00. Excludes fuel and insurance.

* = CO₂ emission figure. Vehicle Excise Duty is based on CO₂ emissions (see page 2 for details). For benefit in kind taxation charges see page 2.



See pages 54-57 for accessory and styling products



See page 47 for fuel data



See page 59 for MasterFit Service Plan details

Option availability

	VXR	Price (£) exc. VAT	Total (£) inc. VAT
Option packs			
Leather Pack • Leather seat facings • Electrically heated Recaro sports front seats • Centre rear seat head restraint • Front passenger's seat height adjuster	○	882.61	1015.00
Sight and Light Pack • Rain-sensitive windscreen wipers • Electro-chromatic anti-dazzle rear-view mirror • Automatic lighting control	○	173.91	200.00
Interior options			
Electronic Climate Control (ECC) incorporating air conditioning 1 see page 52	○	247.83	285.00
Cruise control	○	182.61	210.00
Mechanical options			
Interactive Driving System-plus (IDS-plus) with Continuous Damping Control (CDC) 1 see page 53	○	369.57	425.00
Remus stainless steel 70mm sports exhaust system, incorporating front de-cat downpipe, centre section and sport catalyts, with straight through link pipe, single rear silencer and chrome oval tailpipe with embossed VXR logo – retailer-fit (excluding fitting) 1 see page 39 for ordering details	○	739.13	850.00
Exterior and convenience options			
Electrically foldable door mirrors	○	139.13	160.00
Adaptive Forward Lighting (AFL) incorporating bi-xenon headlights with dynamic beam levelling and high-pressure washers 1 see page 52	○	639.13	735.00
19-inch multi-spoke alloy wheels with anthracite inner; 235/35 R 19 ultra-low profile tyres	○	560.87	645.00
Dark-tinted windows (excludes windscreen and front door windows)	○	226.09	260.00
Rear parking distance sensor 1 see page 51	○	317.39	365.00
Two-coat metallic or pearlescent paint	○	343.48	395.00
Audio and communication options			
CDC 40 • Integral six-disc CD autochanger with MP3 format • Stereo radio • Graphic display ¹	○	343.48	395.00
CD 70 • Satellite navigation system • CD player with MP3 format • Stereo radio • Auxiliary-in socket • Colour monitor 1 see page 50	○	1065.22	1225.00
Mobile phone system with Bluetooth® (does not include phone or cradle) – see page 57 for details of mobile phone compatibility 1 see page 50	○	256.52	295.00

○ = Optional at extra cost.

1 = Deletes auxiliary-in socket.

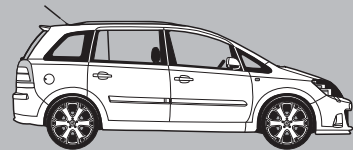

5-door MPV

Model	Price (£)	VAT (£)	Total (£)	On-the-road RRP (£)	CO ₂ * (g/km)
Zafira VXR					
2.0i 16v Turbo (240PS)	19273.91	2891.09	22165.00	23235.00	230

Please note: On-the-road recommended retail prices (RRP) include number plates and delivery to retailer of £615.00 (inc. £80.22 VAT), 12 months' Vehicle Excise Duty (see page 2) and new vehicle first registration fee of £55.00. Excludes fuel and insurance.

* = CO₂ emission figure. Vehicle Excise Duty is based on CO₂ emissions (see page 2 for details). For benefit in kind taxation charges see page 2.



See pages 54-57 for accessory and styling products



See page 47 for fuel data



See page 59 for MasterFit Service Plan details

Option availability

	VXR	Price (£) exc. VAT	Total (£) inc. VAT
Option packs			
Leather Pack ¹ • Leather seat facings • Electrically heated Recaro sports front seats with tilt and lumbar adjustment • Front passenger's seat height adjuster • Centre rear seat head restraint	<input type="radio"/>	939.13	1080.00
Sight and Light Pack • Rain-sensitive windscreen wipers • Electro-chromatic anti-dazzle rear-view mirror • Automatic lighting control	<input type="radio"/>	173.91	200.00
FlexOrganiser® Organiser Pack • 3D storage net • Side net pocket • Four side rail hooks	<input type="radio"/>	43.48	50.00
Interior options			
Electronic Climate Control (ECC) ⓘ see page 52	<input type="radio"/>	247.83	285.00
Cruise control	<input type="radio"/>	182.61	210.00
Exterior and convenience options			
Electrically foldable door mirrors	<input type="radio"/>	139.13	160.00
Adaptive Forward Lighting (AFL) incorporating bi-xenon headlights with dynamic beam levelling and high-pressure washers ⓘ see page 52	<input type="radio"/>	639.13	735.00
Alloy-effect roof rails ²	<input type="radio"/>	91.30	105.00
19-inch multi-spoke alloy wheels with anthracite inner; 235/35 R 19 ultra-low profile tyres	<input type="radio"/>	560.87	645.00
Front and rear parking distance sensors ⓘ see page 51	<input type="radio"/>	317.39	365.00
Two-coat metallic or pearlescent paint	<input type="radio"/>	343.48	395.00
Audio and communication options			
CDC 40 • Integral six-disc CD autochanger with MP3 format • Stereo radio • Graphic display ³	<input type="radio"/>	343.48	395.00
CD 70 • Satellite navigation system • CD player with MP3 format • Stereo radio • Auxiliary-in socket • Colour monitor ⓘ see page 50	<input type="radio"/>	1065.22	1225.00
Rear seat Twin Audio® system with single headset ⓘ see page 50	<input type="radio"/>	91.30	105.00
Mobile phone system with Bluetooth® (does not include phone or cradle) – see page 57 for details of mobile phone compatibility ⓘ see page 50	<input type="radio"/>	256.52	295.00

○ = Optional at extra cost.

¹ = Deletes front passenger's underseat storage tray. ² = Must be used with separate base carrier (available as a Vauxhall accessory) if luggage is to be carried on the roof. ³ = Deletes auxiliary-in socket.

5-door hatchback/estate

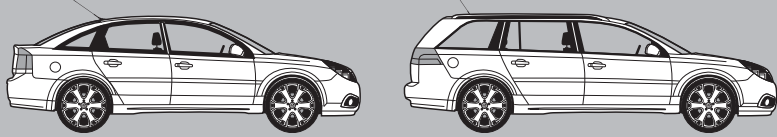

Model	Price (£)	VAT (£)	Total (£)	On-the-road RRP (£)	CO ₂ * (g/km)
Vectra VXR 5-door hatchback					
2.8i V6 24v Turbo (280PS)	21039.13	3155.87	24195.00	25265.00	250
Vectra VXR 5-door estate					
2.8i V6 24v Turbo (280PS)	21973.91	3296.09	25270.00	26340.00	252

Please note: On-the-road recommended retail prices (RRP) include number plates and delivery to retailer of £615.00 (inc. £80.22 VAT), 12 months' Vehicle Excise Duty (see page 2) and new vehicle first registration fee of £55.00. Excludes fuel and insurance.

* = CO₂ emission figure. Vehicle Excise Duty is based on CO₂ emissions (see page 2 for details). For benefit in kind taxation charges see page 2.



See pages 54-57 for accessory and styling products



See page 47 for fuel data

Option availability

	VXR	Price (£) exc. VAT	Total (£) inc. VAT
Option packs			
Leather Pack • Leather seat facings • Electrically heated Recaro sports front seats • Eight-way electrical adjustment for driver's and front passenger's seats	○	1278.26	1470.00
Towing Pack¹ (estate) • Trailer stability programme • Retractable tow bar	○	600.00	690.00
FlexOrganiser® Organiser Pack (estate) • 3D storage net • Side net pocket • Four side rail hooks	○	43.48	50.00
Interior option			
Electronic Climate Control (ECC) incorporating air conditioning i see page 52	○	234.78	270.00
Vertical load-restraining net (estate only) ²	○	130.43	150.00
Exterior and convenience options			
19-inch multi-spoke alloy wheels with anthracite inner, 235/35 R 19 ultra-low profile tyres	○	513.04	590.00
Adaptive Forward Lighting (AFL) incorporating bi-xenon headlights with beam levelling and high-pressure headlight washers i see page 52	○	726.09	835.00
Power tailgate (estate only)	○	426.09	490.00
Alloy-effect roof rails (estate only) ³	○	86.96	100.00
Front and rear parking distance sensors i see page 51	○	365.22	420.00
Two-coat metallic or pearlescent paint	○	343.48	395.00
Audio and communication options			
CD 70 • Satellite navigation system • CD player with MP3 format • Stereo radio • Auxiliary-in socket • Colour monitor i see page 50	○	682.61	785.00
Mobile phone system with Bluetooth® (does not include phone or cradle) ⁴ - see page 57 for details of mobile phone compatibility i see page 50	○	256.52	295.00

○ = Optional at extra cost.

1 = Please note: a separate electrical adaptor (13-pin to 7-pin) is required - available as an accessory at extra cost. This adaptor does not allow for supplementary trailer power requirements. **2** = Includes fixing points for accessory dog guard.

3 = Must be used with separate base carrier (available as a Vauxhall accessory) if luggage is to be carried on the roof.

4 = Deletes drinks holders in centre console.

4-door saloon

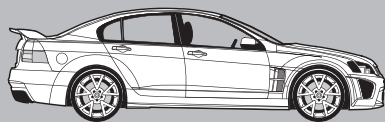

Model	Price (£)	VAT (£)	Total (£)	On-the-road RRP (£)	CO ₂ * (g/km)
VXR8					
6.2iV8 (431PS)	29713.04	4456.96	34170.00	35240.00	364
6.2iV8 (431PS) auto	30926.09	4638.91	35565.00	36635.00	345

Please note: On-the-road recommended retail prices (RRP) include number plates and delivery to retailer of £615.00 (inc. £80.22 VAT), 12 months' Vehicle Excise Duty (see page 2) and new vehicle first registration fee of £55.00. Excludes fuel and insurance.

* = CO₂ emission figure. Vehicle Excise Duty is based on CO₂ emissions (see page 2 for details). For benefit in kind taxation charges see page 2.

Option availability

	VXR8	Price (£) exc. VAT	Total (£) inc. VAT
Exterior options			
Two-coat metallic or pearlescent paint	N/C	No-cost option	
WPP stainless steel sports exhaust system incorporating single centre box and twin rear silencers complete with WPP embossed oval tailpipes – includes fitting 1 see below for ordering details	○	947.83	1090.00
Audio and communication options			
Integrated satellite navigation system ¹	○	1304.35	1500.00
Integrated satellite navigation system (retailer-fit) ²	○	1304.35	1500.00

○ = Optional at extra cost. N/C = No-cost option.

¹ = Total price comprises £1383.00 inc. VAT for the factory-fit satellite navigation system plus £117.00 for the accessory satellite navigation disc. ² = Total price includes satellite navigation system, fitting and accessory satellite navigation disc.



See pages 54-57 for accessory and styling products



See page 47 for fuel data



walkinshaw
PERFORMANCE

Walkinshaw Performance has a simple and passionate vision – to bring your car to life with the very best in high performance upgrades. As the Vauxhall approved supplier for VXR8 enhancements, they offer a range of performance options. For more details, visit www.walkinshawperformance.co.uk, telephone 01608 672922 or contact your local VXR8 retailer.



	Trans- mission	Fuel economy mpg (litres/100km)		
		Urban driving	Extra-urban driving	Combined figure

Agila

1.0i 12v ecoFLEX	manual	47.9 (5.9)	64.2 (4.4)	56.5 (5.0)
1.2i 16v	manual	40.9 (6.9)	60.1 (4.7)	51.4 (5.5)
1.2i 16v	automatic	36.2 (7.8)	57.6 (4.9)	47.9 (5.9)
1.3CDTi 16v ecoFLEX	manual	51.4 (5.5)	70.6 (4.0)	62.8 (4.5)

Tigra

1.4i 16v	manual	34.9 (8.1)	56.5 (5.0)	46.3 (6.1)
1.4i 16v	Easytronic	35.3 (8.0)	57.6 (4.9)	47.1 (6.0)
1.8i 16v	manual	27.2 (10.4)	48.7 (5.8)	37.7 (7.5)
1.3CDTi 16v	manual	48.7 (5.8)	72.4 (3.9)	61.4 (4.6)

Corsa

1.0i 12v	manual	38.7 (7.3)	61.4 (4.6)	50.4 (5.6)
1.2i 16v exc. SXi	manual	36.7 (7.7)	60.1 (4.7)	48.7 (5.8)
1.2i 16v SXi	manual	35.3 (8.0)	56.5 (5.0)	46.3 (6.1)
1.2i 16v exc. SXi	Easytronic	37.2 (7.6)	61.4 (4.6)	49.6 (5.7)
1.4i 16v	manual	35.3 (8.0)	56.5 (5.0)	46.3 (6.1)
1.4i 16v 3-dr hatch	automatic	33.2 (8.5)	53.3 (5.3)	43.5 (6.5)
1.4i 16v 5-dr hatch	automatic	32.8 (8.6)	52.3 (5.4)	42.8 (6.6)
1.6i 16v Turbo (150PS)	manual	26.9 (10.5)	44.1 (6.4)	35.8 (7.9)
1.3CDTi 16v (75PS) ecoFLEX	manual	49.6 (5.7)	74.3 (3.8)	62.8 (4.5)
1.3CDTi 16v (90PS)	manual	45.6 (6.2)	70.6 (4.0)	58.9 (4.8)
1.7CDTi 16v 3-dr hatch	manual	45.6 (6.2)	70.6 (4.0)	58.9 (4.8)
1.7CDTi 16v 5-dr hatch	manual	44.8 (6.3)	68.9 (4.1)	57.6 (4.9)

	Trans- mission	Fuel economy mpg (litres/100km)		
		Urban driving	Extra-urban driving	Combined figure

Meriva

1.4i 16v	manual	34.9 (8.1)	55.4 (5.1)	45.6 (6.2)
1.6i 16v	manual	31.7 (8.9)	52.3 (5.4)	42.2 (6.7)
1.6i 16v	Easytronic	31.7 (8.9)	52.3 (5.4)	42.2 (6.7)
1.8i 16v	manual	27.4 (10.3)	50.4 (5.6)	38.7 (7.3)
1.8i 16v	Easytronic	28.0 (10.1)	49.6 (5.7)	38.7 (7.3)
1.3CDTi 16v	manual	45.6 (6.2)	65.7 (4.3)	56.5 (5.0)
1.7CDTi 16v	manual	42.8 (6.6)	64.2 (4.4)	54.3 (5.2)

Astra Sport Hatch

1.4i 16v	manual	35.3 (8.0)	56.5 (5.0)	46.3 (6.1)
1.6i 16v VVT ¹	manual	32.5 (8.7)	54.3 (5.2)	43.5 (6.5)
1.6i 16v VVT ²	manual	32.1 (8.8)	53.3 (5.3)	42.8 (6.6)
1.6i 16v VVT	Easytronic	33.2 (8.5)	56.5 (5.0)	44.8 (6.3)
1.8i 16v VVT ¹	manual	29.1 (9.7)	50.4 (5.6)	39.8 (7.1)
1.8i 16v VVT ²	manual	28.8 (9.8)	49.6 (5.7)	39.2 (7.2)
1.8i 16v VVT ¹	automatic	27.2 (10.4)	46.3 (6.1)	36.7 (7.7)
1.8i 16v VVT ²	automatic	26.9 (10.5)	45.6 (6.2)	36.2 (7.8)
1.6i 16v Turbo	manual	27.4 (10.3)	45.6 (6.2)	36.7 (7.7)
1.7CDTi 16v (100PS) ¹	manual	44.1 (6.4)	67.3 (4.2)	56.5 (5.0)
1.7CDTi 16v (100PS) ²	manual	43.5 (6.5)	65.7 (4.3)	55.4 (5.1)
1.7CDTi 16v (110PS) ecoFLEX	manual	50.4 (5.6)	72.4 (3.9)	62.8 (4.5)
1.9CDTi (120PS)	manual	39.2 (7.2)	60.1 (4.7)	50.4 (5.6)
1.9CDTi (120PS)	automatic	29.4 (9.6)	53.3 (5.3)	40.9 (6.9)
1.9CDTi 16v (150PS)	manual	39.2 (7.2)	60.1 (4.7)	50.4 (5.6)

The fuel consumption figures shown comply with EC directive 1999/100 to provide a realistic indication of fuel consumption by taking into account everyday driving conditions, such as cold starts, acceleration and braking. These figures take account of the vehicle's kerbweight, ascertained in accordance with the above regulation. **Important:** the results given relate to the particular car tested. Variations in trim level and equipment may result in slightly higher fuel consumption and CO₂ emission levels than those quoted. Driving style, road and traffic conditions, vehicle mileage and standard of maintenance may also affect fuel consumption; therefore the results do not express or imply any guarantee of fuel consumption attainable.

¹ = Figures apply to vehicles fitted with wheels up to 16 inches in diameter.

² = Figures apply to vehicles fitted with 17-inch or 18-inch wheels.

	Transmission	Fuel economy mpg (litres/100km)		
		Urban driving	Extra-urban driving	Combined figure
Astra				
1.4i 16v	manual	35.3 (8.0)	56.5 (5.0)	46.3 (6.1)
1.6i 16v VVT ¹	manual	32.5 (8.7)	54.3 (5.2)	43.5 (6.5)
1.6i 16v VVT ²	manual	32.1 (8.8)	53.3 (5.3)	42.8 (6.6)
1.6i 16v VVT	Easytronic	33.2 (8.5)	56.5 (5.0)	44.8 (6.3)
1.8i 16v VVT ¹	manual	29.1 (9.7)	50.4 (5.6)	39.8 (7.1)
1.8i 16v VVT ²	manual	28.8 (9.8)	49.6 (5.7)	39.2 (7.2)
1.8i 16v VVT ¹	automatic	27.2 (10.4)	46.3 (6.1)	36.7 (7.7)
1.8i 16v VVT ²	automatic	26.9 (10.5)	45.6 (6.2)	36.2 (7.8)
1.6i 16v Turbo	manual	27.4 (10.3)	45.6 (6.2)	36.7 (7.7)
1.3CDTi 16v (90PS)	manual	44.8 (6.3)	68.9 (4.1)	57.6 (4.9)
1.7CDTi 16v (100PS) Life	manual	44.1 (6.4)	67.3 (4.2)	56.5 (5.0)
1.7CDTi 16v (100PS) (exc. Life)	manual	43.5 (6.5)	65.7 (4.3)	55.4 (5.1)
1.7CDTi 16v (110PS) ecoFLEX	manual	50.4 (5.6)	72.4 (3.9)	62.8 (4.5)
1.9CDTi (120PS)	manual	39.2 (7.2)	60.1 (4.7)	50.4 (5.6)
1.9CDTi (120PS)	automatic	29.4 (9.6)	53.3 (5.3)	40.9 (6.9)
1.9CDTi 16v (150PS)	manual	39.2 (7.2)	60.1 (4.7)	50.4 (5.6)

Astra estate

1.4i 16v	manual	35.3 (8.0)	56.5 (5.0)	46.3 (6.1)
1.6i 16v VVT ¹	manual	32.1 (8.8)	53.3 (5.3)	42.8 (6.6)
1.6i 16v VVT ²	manual	31.7 (8.9)	52.3 (5.4)	42.2 (6.7)
1.6i 16v VVT	Easytronic	32.8 (8.6)	55.4 (5.1)	44.1 (6.4)
1.8i 16v VVT ¹	manual	29.1 (9.7)	50.4 (5.6)	39.8 (7.1)
1.8i 16v VVT ²	manual	28.8 (9.8)	49.6 (5.7)	39.2 (7.2)
1.8i 16v VVT ¹	automatic	26.9 (10.5)	45.6 (6.2)	36.2 (7.8)
1.8i 16v VVT ²	automatic	26.6 (10.6)	44.8 (6.3)	35.8 (7.9)
1.6i 16v Turbo	manual	27.4 (10.3)	45.6 (6.2)	36.7 (7.7)
1.3CDTi 16v (90PS)	manual	44.8 (6.3)	68.9 (4.1)	57.6 (4.9)
1.7CDTi 16v (100PS) Life	manual	44.1 (6.4)	67.3 (4.2)	56.5 (5.0)
1.7CDTi 16v (100PS) (exc. Life)	manual	43.5 (6.5)	65.7 (4.3)	55.4 (5.1)
1.7CDTi 16v (110PS) ecoFLEX	manual	50.4 (5.6)	72.4 (3.9)	62.8 (4.5)
1.9CDTi (120PS)	manual	39.2 (7.2)	60.1 (4.7)	50.4 (5.6)
1.9CDTi (120PS)	automatic	29.1 (9.7)	52.3 (5.4)	40.4 (7.0)
1.9CDTi 16v (150PS)	manual	39.2 (7.2)	60.1 (4.7)	50.4 (5.6)

	Transmission	Fuel economy mpg (litres/100km)		
		Urban driving	Extra-urban driving	Combined figure
Astra TwinTop				
1.6i 16v VVT	manual	31.4 (9.0)	51.4 (5.5)	41.5 (6.8)
1.8i 16v VVT	manual	28.2 (10.0)	47.9 (5.9)	38.2 (7.4)
1.8i 16v VVT	automatic	26.4 (10.7)	44.1 (6.4)	35.3 (8.0)
2.0i 16v Turbo (200PS)	manual	21.2 (13.3)	38.7 (7.3)	29.7 (9.5)
1.9CDTi 16v (150PS)	manual	37.2 (7.6)	55.4 (5.1)	47.1 (6.0)

Zafira

1.6i 16v	manual	30.1 (9.4)	47.9 (5.9)	39.2 (7.2)
1.8i 16v VVT	manual	28.5 (9.9)	47.1 (6.0)	38.2 (7.4)
1.8i 16v VVT	Easytronic	29.1 (9.7)	48.7 (5.8)	39.2 (7.2)
2.2i 16v Direct	manual	25.0 (11.3)	44.1 (6.4)	34.4 (8.2)
2.2i 16v Direct	automatic	24.4 (11.6)	42.2 (6.7)	33.2 (8.5)
2.0i 16v Turbo	manual	21.2 (13.3)	38.7 (7.3)	29.7 (9.5)
1.9CDTi (120PS)	manual	37.2 (7.6)	55.4 (5.1)	47.1 (6.0)
1.9CDTi (120PS) Breeze/Breeze Plus	automatic	28.8 (9.8)	49.6 (5.7)	39.2 (7.2)
1.9CDTi (120PS) (excl. Breeze/Breeze Plus)	automatic	29.4 (9.6)	51.4 (5.5)	40.4 (7.0)
1.9CDTi 16v (150PS)	manual	37.2 (7.6)	55.4 (5.1)	47.1 (6.0)
1.9CDTi 16v (150PS)	automatic	28.8 (9.8)	49.6 (5.7)	39.2 (7.2)

Insignia hatchback/saloon

1.8i 16v VVT	manual	26.4 (10.7)	47.1 (6.0)	36.7 (7.7)
2.0i 16v Turbo saloon	manual	22.2 (12.7)	43.5 (6.5)	32.1 (8.8)
2.0i 16v Turbo hatchback	manual	22.1 (12.8)	43.5 (6.5)	32.1 (8.8)
2.0i 16v Turbo	automatic	19.9 (14.2)	40.9 (6.9)	29.4 (9.6)
2.0i 16v Turbo 4X4	manual	21.6 (13.1)	40.9 (6.9)	30.7 (9.2)
2.0i 16v Turbo 4X4	automatic	19.6 (14.4)	39.8 (7.1)	28.8 (9.8)
2.8i V6 24v Turbo 4X4	automatic	16.0 (17.6)	34.9 (8.1)	24.4 (11.6)
2.0CDTi 16v (130PS)	manual	36.7 (7.7)	60.1 (4.7)	48.7 (5.8)
2.0CDTi 16v (130PS) saloon	automatic	30.7 (9.2)	54.3 (5.2)	42.2 (6.7)
2.0CDTi 16v (130PS) hatchback	automatic	30.4 (9.3)	53.3 (5.3)	41.5 (6.8)
2.0CDTi 16v (160PS)	manual	36.7 (7.7)	60.1 (4.7)	48.7 (5.8)
2.0CDTi 16v (160PS) saloon	automatic	30.7 (9.2)	54.3 (5.2)	42.2 (6.7)
2.0CDTi 16v (160PS) hatchback	automatic	30.4 (9.3)	53.3 (5.3)	41.5 (6.8)

	Trans- mission	Fuel economy mpg (litres/100km)		
		Urban driving	Extra-urban driving	Combined figure

Insignia Sports Tourer

1.8i 16v VVT	manual	25.9 (10.9)	45.6 (6.2)	35.8 (7.9)
2.0i 16v Turbo	manual	21.9 (12.9)	42.8 (6.6)	31.7 (8.9)
2.0i 16v Turbo	automatic	19.8 (14.3)	40.4 (7.0)	29.1 (9.7)
2.0i 16v Turbo 4X4	manual	21.4 (13.2)	40.4 (7.0)	30.4 (9.3)
2.0i 16v Turbo 4X4	automatic	19.5 (14.5)	39.2 (7.2)	28.5 (9.9)
2.8i V6 24v Turbo 4X4	automatic	15.9 (17.8)	34.0 (8.3)	23.9 (11.8)
2.0CDTi 16v (130PS)	manual	35.8 (7.9)	57.6 (4.9)	47.1 (6.0)
2.0CDTi 16v (130PS)	automatic	29.7 (9.5)	52.3 (5.4)	40.9 (6.9)
2.0CDTi 16v (160PS)	manual	35.8 (7.9)	57.6 (4.9)	47.1 (6.0)
2.0CDTi 16v (160PS)	automatic	29.7 (9.5)	52.3 (5.4)	40.9 (6.9)

Vectra hatchback

1.8i 16v VVT	manual	28.0 (10.1)	51.4 (5.5)	39.2 (7.2)
2.2i 16v Direct	manual	27.4 (10.3)	47.9 (5.9)	37.7 (7.5)
1.9CDTi (120PS)	manual	38.2 (7.4)	60.1 (4.7)	49.6 (5.7)
1.9CDTi 16v (150PS)	manual	38.2 (7.4)	60.1 (4.7)	49.6 (5.7)
1.9CDTi 16v (150PS)	automatic	29.7 (9.5)	52.3 (5.4)	40.9 (6.9)
3.0CDTi V6 24v	automatic	27.7 (10.2)	53.3 (5.3)	39.8 (7.1)

Vectra estate

1.8i 16v VVT	manual	27.4 (10.3)	47.9 (5.9)	37.7 (7.5)
1.9CDTi (120PS)	manual	37.7 (7.5)	58.9 (4.8)	48.7 (5.8)
1.9CDTi 16v (150PS)	manual	37.7 (7.5)	58.9 (4.8)	48.7 (5.8)
1.9CDTi 16v (150PS)	automatic	29.4 (9.6)	51.4 (5.5)	40.4 (7.0)

	Trans- mission	Fuel economy mpg (litres/100km)		
		Urban driving	Extra-urban driving	Combined figure

Antara

2.0CDTi 16v	manual	32.5 (8.7)	41.5 (6.8)	37.2 (7.6)
2.0CDTi 16v	automatic	25.9 (10.9)	38.7 (7.3)	32.8 (8.6)

VXR

Corsa 1.6i 16v Turbo (192PS)	manual	26.9 (10.5)	44.1 (6.4)	35.8 (7.9)
Meriva 1.6i 16v Turbo (180PS)	manual	27.2 (10.4)	44.8 (6.3)	36.2 (7.8)
Zafira 2.0i 16v Turbo (240PS)	manual	21.1 (13.4)	38.2 (7.4)	29.4 (9.6)
Astra 2.0i 16v Turbo (240PS)	manual	21.7 (13.0)	40.4 (7.0)	30.7 (9.2)
Vectra hatchback 2.8i V6 24v Turbo (280PS)	manual	18.2 (15.5)	38.2 (7.4)	27.2 (10.4)
Vectra estate 2.8i V6 24v Turbo (280PS)	manual	18.1 (15.6)	37.7 (7.5)	26.9 (10.5)
VXR8 6.2i V8 (431PS)	manual	12.7 (22.3)	25.4 (11.1)	18.6 (15.2)
VXR8 6.2i V8 (431PS)	automatic	13.6 (20.8)	26.2 (10.8)	19.5 (14.5)

The fuel consumption figures shown comply with EC directive 1999/100 to provide a realistic indication of fuel consumption by taking into account everyday driving conditions, such as cold starts, acceleration and braking. These figures take account of the vehicle's kerbweight, ascertained in accordance with the above regulation. **Important:** the results given relate to the particular car tested. Variations in trim level and equipment may result in slightly higher fuel consumption and CO₂ emission levels than those quoted. Driving style, road and traffic conditions, vehicle mileage and standard of maintenance may also affect fuel consumption; therefore the results do not express or imply any guarantee of fuel consumption attainable.

1 = Figures apply to vehicles fitted with wheels up to 16 inches in diameter.

2 = Figures apply to vehicles fitted with 17-inch or 18-inch wheels.



SWB Combi

Model	Price (£)	VAT (£)	Total (£)	On-the-road RRP (£)	CO ₂ * (g/km)
Vivaro SWB 9-seat Combi					
2900 2.0CDTI 16v (90PS)	18085.00	2712.75	20797.75	21677.75	214



LWB Combi

Model	Price (£)	VAT (£)	Total (£)	On-the-road RRP (£)	CO ₂ * (g/km)
Vivaro LWB 9-seat Combi					
2900 2.0CDTI 16v (115PS)	19500.00	2925.00	22425.00	23305.00	224
2900 2.0CDTI 16v (115PS) Tecshift	20300.00	3045.00	23345.00	24225.00	213

Please note: On-the-road recommended retail prices (RRP) include number plates and delivery to retailer of £615.00 (inc. £80.22 VAT), 12 months' Vehicle Excise Duty (£210.00) and new vehicle first registration fee of £55.00. Excludes fuel and insurance.

* = CO₂ emission figures. Vehicle Excise Duty is based on CO₂ emissions (see page 2 for details). For benefit in kind taxation charges see page 2.

Fuel consumption figures

	Trans- mission	Fuel economy mpg (litres/100km)		
		Urban driving	Extra-urban driving	Combined figure
Vivaro 9-seat Combi				
2.0CDTI 16v (90PS)	manual	28.8 (9.8)	40.4 (7.0)	35.8 (7.9)
2.0CDTI 16v (115PS)	manual	27.7 (10.2)	38.2 (7.4)	33.6 (8.4)
2.0CDTI 16v (115PS)	Tecshift	31.0 (9.1)	38.2 (7.4)	35.3 (8.0)

Option availability

	Combi	Price (£) exc. VAT	Total (£) inc. VAT
Option packs			
Vision Pack • Rain-sensitive windscreen wipers • Automatic lighting control • Front fog lights • Selective door locking	<input type="radio"/>	165.00	189.75
Smoker Pack • Cigar lighter • Front ashtray	<input type="radio"/>	45.00	51.75
Safety and security options			
Front passengers' twin airbag	<input type="radio"/>	235.00	270.25
Electronic Stability Programme-plus (ESP-plus) i see page 53	<input type="radio"/>	400.00	460.00
Remote control ultrasonic security alarm system	<input type="radio"/>	175.00	201.25
Interior and seating options			
Driver's seat with lumbar adjustment and armrest	<input type="radio"/>	50.00	57.50
Driver's seat and single front passenger's seat with lumbar adjustment and armrest	<input type="radio"/>	100.00	115.00
Air conditioning – cab area only	<input type="radio"/>	630.00	724.50
Solar Reflect® windscreen	<input type="radio"/>	55.00	63.25
Additional rear heating ¹	<input type="radio"/>	225.00	258.75
Front and rear air conditioning	<input type="radio"/>	1260.00	1449.00
Mechanical option			
Speed limiter	<input type="radio"/>	75.00	86.25
Rear door option			
Glazed twin rear doors with heated windows and wash/wipe facility	<input type="radio"/>	160.00	184.00
Exterior options			
16-inch recessed alloy wheels (steel spare) with 215/65 R 16 tyres	<input type="radio"/>	420.00	483.00
16-inch alloy wheels (steel spare) with 215/65 R 16 tyres	<input type="radio"/>	420.00	483.00
Two-coat metallic or pearlescent paint	<input type="radio"/>	395.00	454.25
Special paint (restrictions apply – please consult your retailer for availability)	<input type="radio"/>	440.00	506.00
Rear parking distance sensors	<input type="radio"/>	265.00	304.75
Audio and communication options			
CD 70 • Satellite navigation system • CD player with MP3 format • Stereo radio • Auxiliary-in socket • Colour monitor • Steering wheel mounted audio controls	<input type="radio"/>	850.00	977.50
Steering wheel mounted audio controls	<input type="radio"/>	95.00	109.25
Factory-fit telephone pre-wiring	<input type="radio"/>	80.00	92.00

○ = Optional at extra cost.

¹ = Only available in conjunction with front and rear air conditioning on LWB models.

SWB Combi

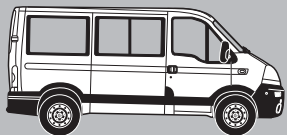

Model	Price (£)	VAT (£)	Total (£)	On-the-road RRP (£)	CO ₂ * (g/km)
Movano SWB 6-seat semi-glazed Combi					
2800 2.5CDTI 16v (100PS)	19860.00	2979.00	22839.00	23909.00	230
Movano SWB 9-seat fully glazed Combi					
2800 2.5CDTI 16v (100PS)	20360.00	3054.00	23414.00	24484.00	230
2800 2.5CDTI 16v (146PS)	22760.00	3414.00	26174.00	27244.00	235

Please note: On-the-road recommended retail prices (RRP) include number plates and delivery to retailer of £615.00 (inc. £80.22 VAT), 12 months' Vehicle Excise Duty (£400.00) and new vehicle first registration fee of £55.00. Excludes fuel and insurance.

* = CO₂ emission figures. Vehicle Excise Duty is based on CO₂ emissions (see page 2 for details). For benefit in kind taxation charges see page 2.

Fuel consumption figures

	Trans- mission	Fuel economy mpg (litres/100km)		
		Urban driving	Extra-urban driving	Combined figure
Movano 6-/9-seat SWB Combi				
2.5CDTI 16v (100PS)	manual	26.6 (10.6)	36.7 (7.7)	32.5 (8.7)
2.5CDTI 16v (146PS)	manual	25.9 (10.9)	36.7 (7.7)	31.7 (8.9)

Option availability

	Combi	Price (£) exc. VAT	Total (£) inc. VAT
Option packs			
Electric Pack • Electrically operated front windows • Electrically adjustable/heated door mirrors	○	285.00	327.75
Technical Pack • Cruise control with driver controllable speed limiter • Trip computer	○	525.00	603.75
Safety and security options			
Front passengers' twin airbag and pyrotechnic body-lock seatbelt pretensioners	○ ¹	250.00	287.50
Remote control ultrasonic security alarm system	○	100.00	115.00
Electronic Stability Programme-plus (ESP-plus) i see page 53	○	750.00	862.50
Interior and seating options			
Single front passenger's seat	N/C ¹	No-cost option	
Single fully adjustable 'comfort' front passenger's seat with armrest	○	55.00	63.25
Multi-function front passenger's bench seat with underseat storage facility	○	105.00	120.75
Tyre inflation kit in lieu of spare wheel	N/C	No-cost option	
Trip computer	○	315.00	362.25
Tilting glass sunroof for saloon area	○	210.00	241.50
Mechanical options			
Digital tachograph ²	○	525.00	603.75
Six-pin connection in battery compartment	○	55.00	63.25
Speed limiter	○	75.00	86.25
Height-adjustable pneumatic rear suspension (not available with ESP-plus)	○	1575.00	1811.25
Tow bar	○ ³	365.00	419.75
Exterior options			
Rain-sensitive windscreen wipers and Automatic Lighting Control (ALC)	○ ⁴	260.00	299.00
Two-coat metallic paint	○	395.00	454.25
Special paint (restrictions apply – please consult your retailer for availability)	○	440.00	506.00
Rear parking distance sensors	○	265.00	304.75
Audio and communication options			
• Stereo radio/cassette player • Traffic Programme	N/C	No-cost option	
• Satellite navigation system • CD player • Stereo radio • Monochromatic display	○	750.00	862.50

○ = Optional at extra cost. N/C = No-cost option.

¹ = Front passengers' twin airbag not available with single front passenger's seat options. ² = Option price for digital tachograph does not include calibration which must be carried out at an approved tachograph centre within 14 days of the vehicles registration. **Please note:** The legislation regarding the use of tachographs is complex and operators should seek independent advice or speak to the Commercial Vehicle specialist at your Vauxhall retailer to ensure compliance. Alternatively your local DVLA office will also be able to provide clarification of the relevant legislation. ³ = Not available with rear parking distance sensors. ⁴ = Mandates Electric Pack and trip computer.

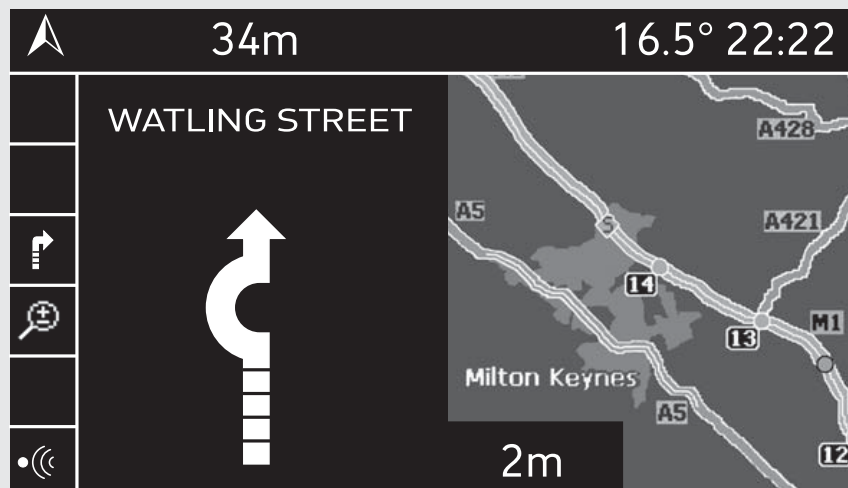

Satellite navigation

Vauxhall's satellite navigation systems are designed for ease of use and extremely high levels of information. Some systems are fitted with the latest Traffic Message Channel (TMC), broadcasting real-time traffic information, delivered either visually or verbally – alerting the driver to a problem on the planned route and then offering an alternative route to avoid the incident.

The systems use the international network of GPS (Global Positioning System) satellites linked to a comprehensive CD-ROM mapping system to determine your precise location and guide you to your chosen destination virtually anywhere in mainland Britain. Additional discs can be purchased for all major European countries, which means that making a cross-European trip can now be as simple as changing a CD.

All units are simple to operate, using a range of menu-driven options which are easily accessed from the central control button or via the steering wheel mounted audio controls. The audible direction guidance prompts give details of road numbers and motorway junction numbers. There are a number of options that enable you to plan your journey – for example by avoiding motorways.

The CD 60 units feature verbal instructions together with schematic arrows displayed in the centrally mounted monochromatic graphic information display. CD 70 units additionally feature a colour monitor (shown above) on most models with a mapping function in addition to the directional arrows.

Mobile phone system with Bluetooth®

Vauxhall's factory-fit dual-band mobile phone system provides integration with the audio and communication system, it also features voice control and will connect wirelessly to phones with Bluetooth® technology.

All the required information is shown on the fascia display when a mobile phone is in use, while the menus are easily navigated by either the steering wheel audio controls or the multi-function button on the radio. Certain functions can also be controlled by voice activation.

The phone system base unit must be fitted with a cradle (available as an accessory) mounted on the centre console – see page 57 for a list of compatible mobile phones.



Please note:

Not all of these features are available on all models. Please see model pages for details.



Rear seat Twin Audio®

Vauxhall's Twin Audio® system provides peace and quiet on long journeys! The system comes with a single headphone set and separate rear controls so front and rear passengers can listen to the radio or a CD totally independently of each other. The rear seat control module sits at the end of the centre console between the two front seats. This provides an on/off switch, independent volume controls for each headset, switching between CD and radio tuner and a scan function.

The system even mutes the rear speakers when any headphones are in use. Additional headphone sets for a second rear seat passenger are available as accessories – contact your Vauxhall retailer for information.



MP3 CD player

An MP3 is a compressed sound or music file which, due to its small size, takes up less space on a compact disc, which means that more tracks can be recorded onto a CD. It's possible to fit almost 10 hours of music onto one CD, and, in a way, turns a single-disc CD/MP3 player into a multi-disc autochanger. Providing you have access to a compatible computer to create the MP3 tracks, you can compress your CD collection and create your own compilations – and you won't have to drive around with all your original CDs in the car.

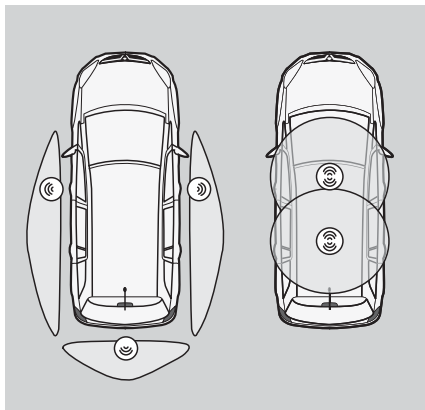

Keyless entry and start

Keyless entry and start system means that the driver need never remove their key fob from their pocket. When approaching the car, sensors in the front door handles and rear bumper detect the driver's proximity and automatically unlock the doors or boot when the handle is pulled.

When in the car, two internal sensors activate the ignition and release the electronic steering lock, enabling the driver to start or stop the engine merely by pressing the facia-mounted Start/ Stop button.

Upon leaving the vehicle, the driver can lock it by either pressing a button on the key fob like a conventional system, or by simply touching one of the sensors on the external handles of the front doors.

Additionally, the system offers excellent theft protection by its use of sophisticated cryptographic algorithms, while a back-up key is also included for emergency use.



Easytronic transmission

Choose any model with Easytronic transmission and you'll get a five speed manual gearbox with a fully automatic mode. In manual mode, you simply push the lever forward or back to shift gears up or down. The facia display tells you what gear you're in – 1 to 5, N for Neutral or A

for Auto. Switch to fully automatic mode and it has many of the features of a regular automatic including a kickdown function. There's no clutch pedal so you can drive it on an automatic-only driving licence.

Automatic transmissions

A range of four, five and six-speed automatic transmissions are matched to the model and engine size. Many use an electronically controlled adaptive driving programme to tailor gearchanges to suit driving conditions and your driving style. And to reduce the chance of wheelspin in icy conditions, the Winter mode selects a higher than normal gear for standing starts. On five and six-speed transmissions the Active Select manual mode allows the gearlever to be used like a manual gearbox in order to change gear exactly when you want – you simply push the lever forward or back to change up or down the gears.

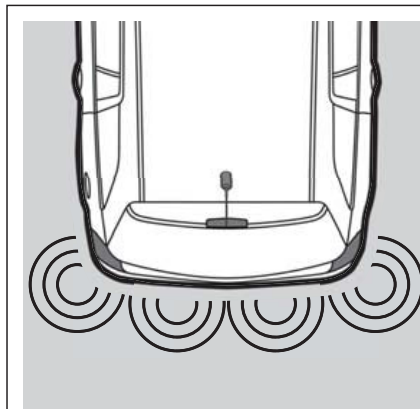

Parking distance sensors

This system helps safeguard your car and pedestrians by providing an audible warning to the driver when an object is detected by one of the sensors. Rear parking distance sensors are operated when reverse gear is selected. Zafira, Insignia and Antara models also feature front parking distance sensors. Additionally there are a range of accessory rear sensors available for fitment by your retailer.

Air conditioning

Air conditioning provides chilled air on hot days and a lot more besides. By dehumidifying the atmosphere inside the car, air conditioning can also increase your comfort and safety with faster window demisting on wet days and an altogether fresher travelling environment the whole year round.



Electronic Climate Control (ECC)

Electronic Climate Control (ECC) offers significant benefits over regular air conditioning by allowing you to set your preferred interior temperature and maintain it, regardless of external temperature and vehicle speed. Switch the system to automatic and it will achieve the desired temperature as swiftly as possible.

A sunlight sensor even accounts for rapid changes in temperature caused by driving in and out of direct sunlight. On some Insignia models the system also allows you to choose different cabin temperatures on each side of the car.



Single-zone Electronic Climate Control (ECC) display as featured on Insignia.

Adaptive Forward Lighting (AFL)

Adaptive Forward Lighting is a sophisticated lighting system that allows you to see around corners by adjusting the headlights to follow the direction of the front wheels. And on some models the 'Cornering light' illuminates kerbs, street signs and tight bends. In fact, *Autocar* magazine were so impressed that they described it as a 'must-have' feature.

Corsa and Meriva models feature AFL with halogen headlights, whilst Astra, Zafira and Insignia models with AFL additionally feature more powerful xenon headlights with dynamic beam-levelling, high pressure washers and the 'Motorway light' function.

Insignia's Intelligent AFL takes account of the location and weather conditions to provide optimum performance through several different light patterns.

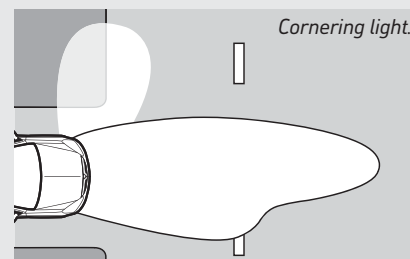

The 'Cornering light' uses an additional bulb and reflector to project a beam of light approximately 90° to the direction of travel when required – for example when turning at junctions or even negotiating tight roundabouts.

The 'Curve light' function is activated by movements of the steering wheel and allows the headlight beam to move up to 15 degrees left or right of the straight ahead position. This ensures that the headlight beams are always aimed in the direction you're about to go – and not necessarily the direction the front of the car is already pointing in!

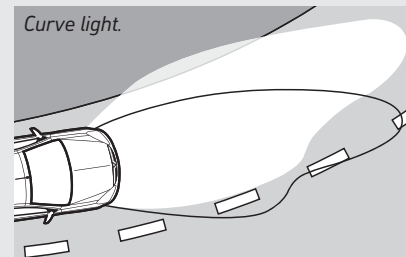

At speeds above 65mph, AFL's 'Motorway light' function raises the dipped headlight beam to extend the range of vision for increased safety at higher speed. The beam automatically returns to its normal position when the car falls below that speed.

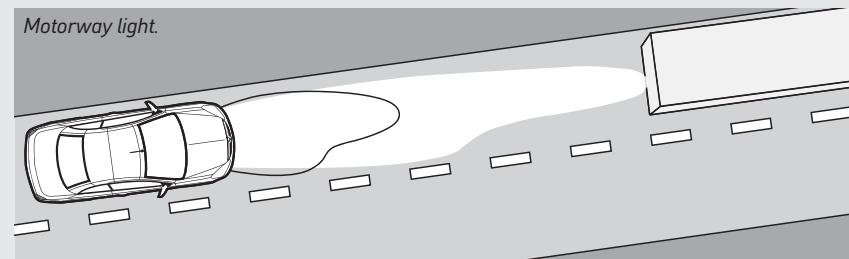

Please note:

Not all of these features are available on all models. Please see model pages for details.

Electronic Stability Programme (ESP)

Electronic Stability Programme has been developed to help the driver maintain control in adverse or emergency situations. ESP compares the direction of the front and rear of the vehicle compared to the driver's steering wheel input. If either the front or rear of the vehicle begins to slide, ESP gently applies corrective braking to the appropriate individual road wheel, controlling and minimising the slide. ESP is utilised in conjunction with Traction Control to

promote safer driving under all road conditions. The latest generation of the system, ESP-plus is an advanced development which features an enhanced yaw compensation system for reducing understeer. This means that ESP-plus has the ability to apply corrective braking to all four road wheels if necessary; a clear advantage over the standard ESP system where only one wheel is retarded in any given situation.

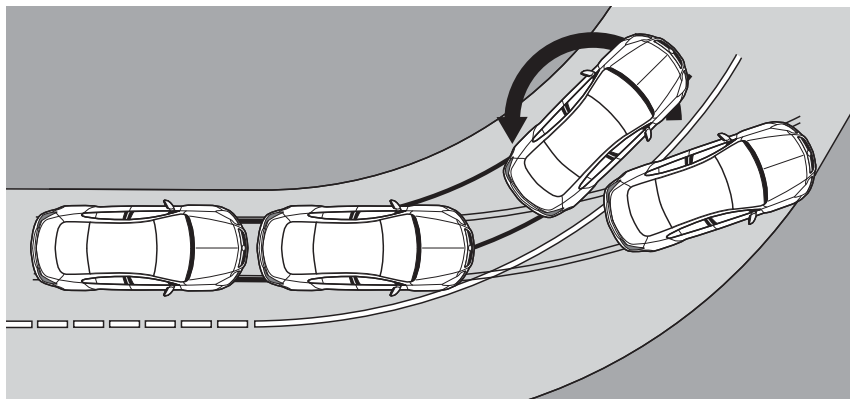

Hill Start Assist (HSA)

As its name suggests, Hill Start Assist helps prevent the vehicle from rolling down gradients of more than five percent immediately after the brake pedal has been released. Brake pressure is maintained for up to 1.5 seconds after the driver releases the pedal, the brakes are released as soon as the driver presses the accelerator and the car moves forward.

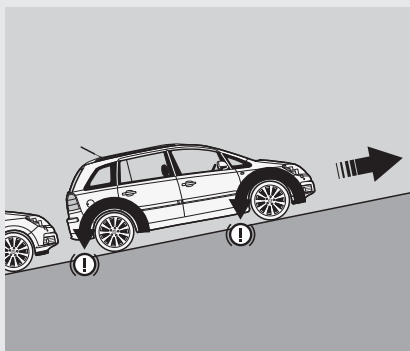

Interactive Driving System-plus (IDS-plus) with Continuous Damping Control (CDC)

The Interactive Driving System (IDS-plus) provides an even sportier driving experience thanks to electronic damping control together with sharper throttle and steering responses. Pressing the 'Sport' switch activates the CDC function which constantly adjusts the rate of damping on

each wheel – effectively stiffening the suspension when required. This means that the vehicle will exhibit a reduced rate of roll and pitch, making it more responsive during direction changes and more settled during the braking/turn-in/acceleration transition when cornering.

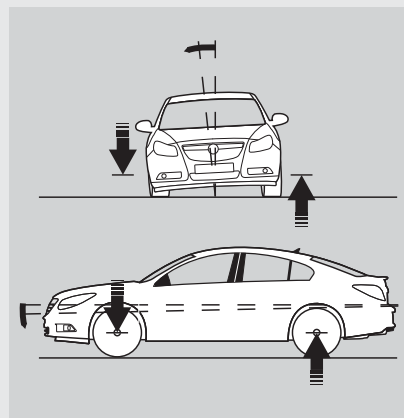

The Sport switch additionally provides a sharper engine response and crisper acceleration, while the power assisted steering is also adjusted, giving the driver a more positive initial turn-in to corners.

VXR models feature an updated system – IDS²-plus.

FlexRide – Insignia

Insignia models feature the latest development of IDS-plus called FlexRide. This provides an additional 'Tour' mode for relaxed long distance cruising.



Vauxhall accessories are comprehensively researched and tested to ensure the same high quality as the vehicle for which they are intended making them the right choice for your Vauxhall. Not all accessories are listed, for further details please contact your Vauxhall retailer and ask for a copy of the Car Accessories brochure or Lo-call 0845 600 1500.



Alternatively, you can find all the details on our website www.vauxhall-accessories.com

VXR exterior styling



Corsa model illustrated features VXR styling front lower spoiler, side sills, rear lower skirt and roof spoiler and optional factory-fitted 17-inch alloy wheels.

	Total (inc. VAT)
VXR Corsa styling (painted and fitted*)	
Styling Pack ¹ • Front lower spoiler • Rear lower skirt • Rear roof spoiler • Side sills • Tyre inflation kit	£1369.23
Rear roof spoiler ¹	£292.64

VXR Tigra styling (painted and fitted*)	
Styling Pack • Front lower spoiler • Rear lower skirt • Rear lip spoiler • Side sills	£1369.23
Rear lip spoiler	£292.64

VXR Astra styling (painted and fitted*)	
Styling Pack A ¹ • Front lower spoiler • Rear lower skirt • Rear roof spoiler • Side sills	£1369.23
– Sport Hatch/hatchback/estate	£1125.53
Styling Pack B • Front lower spoiler • Rear lower skirt • Side sills	£1125.53
– Sport Hatch/hatchback/estate	£1125.53
Rear roof spoiler ¹	£292.64
– Sport Hatch/hatchback/estate	£292.64

VXR TwinTop styling (painted and fitted*)	
Styling Pack • Front lower spoiler • Rear lower skirt • Rear lip spoiler • Side sills	£1369.23
Rear lip spoiler	£292.64

	Total (inc. VAT)
VXR Meriva styling (painted and fitted*)	
Styling Pack ¹ • Front lower spoiler • Rear lower skirt • Rear roof spoiler • Side sills	£1369.23
Rear roof spoiler ¹	£292.64

VXR Zafira styling (painted and fitted*)	
Styling Pack ¹ • Front lower spoiler • Rear lower skirt • Rear roof spoiler • Side sills	£1369.23
Rear roof spoiler ¹	£292.64

VXR Insignia styling (painted and fitted*)	
Rear spoiler	
– hatchback/saloon	£292.64

VXR Vectra styling (painted and fitted*)	
Styling Pack • Front lower spoiler • Rear lower skirt • Rear spoiler • Side sills	£1369.23
Rear spoiler	
– hatchback/saloon/estate	£292.64

¹ = Not suitable for SRI models. Requires additional aerial adaptor at extra cost. Please consult your retailer for details.

Vauxhall retailers regularly feature special offers from our Accessory range.

Speak to your local retailer for more details.

Please note:

* Prices shown are a special fully fitted (and painted, where applicable) price at participating retailers only. Please check with your local Vauxhall retailer for details. All other prices exclude fitting.

It is advisable to ensure your insurance policy is adequate to cover additional fitted accessories.

Prices correct at time of going to press.

Exterior styling*

Front lower spoiler		£423	£455		£377	£482	£458	£574
Front lower skirt extensions	£318			£433	£467			
Front and rear lower skirt inserts – matt aluminium-effect	£176							
Cross hatch grille with 'Irmischer' badge	£153	£189	£145	£174	from £293	£157	£224	£157
Cross hatch grille with aluminium upper and laser-etched 'Irmischer' badge	£202 ²	£220	£178	£192	from £343	£219	£259	£216
Stainless steel mesh grille – upper/lower set		£207					£207 ⁴	
Door mirror covers – chrome-effect – pair			£123		£152		£164	
Stainless steel door handle cover – pair		£60		£60	£60			
Stainless steel door handle cover – set of four		£100			£100	£100	£100	£100
Side sills – pair		£552	£592		£571	£571	from £549	
Stainless steel side running boards – pair								£609
Rear lower skirt							from £487	
Rear bumper sports insert		£295 ³			from £302		£487	
Rear hood spoiler		£411						
Rear roof spoiler	£336		£332		£376	£388	from £358	£406
Rear wing spoiler				£440	from £390		from £449	
Up-rated and lowered spring kit		£277	£389	£351	£397	£407	£404	

Interior styling*

'Irmischer' tax disc holder – anodised aluminium with twist-off back	£23	£23	£23	£23	£23	£23	£23	£23
Aluminium ventilation panel set – LH and RH vents					£65			
Interior door handle covers – matt chrome-effect – pair				£49	£49	£49		
Stainless steel interior door sill covers – pair		£160	£147		£156		£160	
Velour floor mats with heel protector and 'Irmischer' logo – set of four	£69	£69	£69	£60 ⁵	£69	£69	£69	£69
Aluminium pedals with 'Irmischer' logo (manual transmission)		£123	£123	£123	£123	£123	£123	£123
Three spoke steering wheels – leather/various effects ⁶		£281	£466	£466	£546	£546	£546	
Handbrake levers – various effects			£92	£92	£92		£92	
Foldable front centre armrest		£129			£129 ⁷	£129		

Sports silencers*

Split oval design chrome-plated tailpipes		£350 ⁸		£317	£403	£393		
Twin round stainless steel tailpipes				£317				
Twin rectangular stainless steel tailpipes ⁹			£471				£465	
Dual branched split oval design chrome-plated tailpipes ⁹		£524			£543			
Dual branched twin split oval design chrome-plated tailpipes								£599
Dual branched twin rectangular stainless steel tailpipes ⁹							£882	

2 = Matt aluminium-effect upper with moulded 'Irmischer' badge. 3 = Not to be fitted in conjunction with Flex-Fix® rear integrated carrier system. 4 = Not suitable for SRI Nav with Exterior Pack models. 5 = Set of two. 6 = Available with and without audio controls. 7 = Not suitable for vehicles with mobile phone system with Bluetooth® and only suitable for vehicles fitted with optional Smoker Pack. 8 = Not suitable for SRI models or models fitted with VXR Styling Pack One. SXi models require rear bumper sports insert. 9 = Must be used in conjunction with Irmischer rear bumper sports insert (Corsa and Astra) or rear lower skirt (Vectra). 10 = Certain wheel/tyre combinations may also require modification to the wheel arches.



Softstar
6J x 14 £591



Stila
6½J x 15 £653
6½J x 16 £722
8J x 18 £1412



Signa
6½J x 16 £722
8J x 18 £1412



GT Star
6½J x 16 £722
8J x 19 £1707



Sport Star
7J x 17 £1158¹⁰
8J x 18 £1605



Evo Star
7½J x 18 £1412
Vectra
8½J x 20 £1810
Antara
8½J x 20 £1836

Please note: Fully fitted price, excluding tyres, includes static wheel balancing. Fitting larger diameter wheels than standard will require the fitment of new tyres at extra cost. Many other styles and finishes are available, see website for details.

Safety

	Total (inc.VAT)
Rear parking distance sensor – bumper mounted ¹¹ (fitted*)	
– Astra/Zafira/Vectra	£390.51

Security

	Total (inc.VAT)
Steering wheel security bar	
– all models (except Antara)	£57.50

Practical

	Total (inc.VAT)
Hi-visibility vest	£5.37
Spare bulb kit ¹²	
– all models except Agila/Insignia/VXR8	£11.19
Fuel can – 5-litre – all models	£13.69
Stretch tow rope (2 tonne rated)	
– all models	£20.94
Fire extinguisher – all models – 1kg	£22.48
First aid kit	£9.29
Warning triangle	£11.85

Please note:

* Prices shown are a special fully fitted (and painted, where applicable) price at participating retailers only. Please check with your local Vauxhall retailer for details. All other prices exclude fitting.

It is advisable to ensure your insurance policy is adequate to cover additional fitted accessories.

Prices correct at time of going to press.

Protection

	Total (inc.VAT)
Rubber floor mats (front pair)	
– Corsa/Meriva/Tigra/Astra/Astra TwinTop/Zafira/Vectra	£20.06
Rubber floor mats (rear pair)	
– Corsa/Meriva/Astra/Astra TwinTop/Vectra	from £14.49
Rubber floor mats (set of four)	
– Agila	£34.25
– Zafira (second/third row)	£20.06
– Insignia	£38.64
– Antara	£36.20
Economy floor mats (set of four)	
– all models except Antara/VXR8	£18.51
Velour floor mats (set of four, Zafira set of six)	
– all models except VXR8	£40.08
Deluxe velour floor mats (set of four)	
– Meriva/Astra/Astra TwinTop/Zafira (set of six)/Vectra	from £49.91
Contoured velour floor mats (set of four)	
– Meriva/Astra/Vectra	from £53.82
Dog guard (fitted*) ¹³	
– Meriva (behind front seats only)/Astra estate/Vectra estate	£101.64
– Zafira	£130.02
Space divider grid (for use with dog guard)	
– Astra estate/Vectra estate	£85.83
– Zafira	£113.83
FlexOrganiser® divider mesh – Antara	£85.68
Load-restraining floor net	
– Astra estate/Zafira/Vectra	£26.91
Bootliner – flexible liner with storage bag	
– Tigra	£66.54
Cargo liner – rigid moulded plastic liner	
– Agila	£34.25
– Corsa/Meriva/Astra/Sport Hatch/Zafira/Vectra/Antara	£48.93
Cargo liner – reversible anti-slip – Antara	£76.34
Headlight protectors – standard	
– Corsa/Tigra/Astra/Zafira/Meriva (includes continental touring convertor decals)	£38.12
Headlight protectors – carbon fibre-effect	
– Corsa/Meriva/Tigra/Astra/Zafira/Vectra	£38.12



Floor mat sets from: **£18.51**

	Total (inc.VAT)
Mudflaps (set of four – fitted*) ¹⁴	
– all models except Tigra/Astra TwinTop/VXR8	£73.40
Windbreak	
– Tigra	£158.54
– Astra TwinTop	£199.65

¹¹ = Only available if vehicle is equipped with an REC unit. Please consult your retailer for further information.

¹² = Not for vehicles with xenon headlights or Adaptive Forward Lighting.

¹³ = Requires additional fitting kit at £97.74 (fitted*) for Astra estate and Zafira, £90.05 (fitted*) for Vectra estate, if vehicle is not equipped with the factory-fit vertical load restraining net option or dog guard fixing points.

¹⁴ = Not available on some models when fitted with exterior styling accessories.



Sport roof box: **£273.70**

Load carriers

	Total (inc.VAT)
Roof carrier system ¹⁵ – all models except Tigra/Astra TwinTop/VXR8	
Base carrier	
– all models except Antara	£96.60
– Antara	£127.65
Premium bicycle carrier ¹⁶	
– all models except Insignia	£67.53
Side loading bicycle carrier ¹⁷	
– Corsa/Astra/Vectra/Insignia	£146.80
– Agila/Meriva/Zafira	£176.16
Alloy ski/snowboard carrier-fixed ¹⁶	£54.81
Roof box	
– Agila	£166.75
Sport roof box (450 litres) ¹⁶	£273.70
Travel roof box (450 litres) ¹⁶	£246.63

¹⁵ = Roof carrier systems vary dependent on model. Please consult your retailer for details.

¹⁶ = Must be used in conjunction with a base carrier.

¹⁷ = Must be used in conjunction with a base carrier. Requires installation kit at extra cost of £16.33.

Tow bar carrier system – all models except Agila/Tigra/Antara/VXR8

Bicycle carrier – tow bar mounted two bicycle carrier with rear lights (excludes number plate) £249.56

Additional bicycle carrier (for use with two bicycle carrier) – all models except Corsa £74.18

Mobile phones/Navigation

	Total (inc.VAT)
Hands-free Bluetooth® mobile phone cradle – only available with factory-fit option on Corsa/ Meriva/Astra/Zafira/Vectra/Antara. Suitable for the following mobile phones:	
– Motorola V400/500/525/550/600/620/635/ L2/L6/L7/SLVR	
– Nokia 3100/6100/6020/6021/6151/6220 (excl. Classic)/ 6230/6233/6234/6310(i)/6610/6820/7210/ 7250(i)	
– Siemens C65/CX65/M55/M65/S55/S65/S68/C55/ CX70/SP65/C75/CX75/M75/S75	
– Sony-Ericsson K510i/K610i/K700i/K750i/K800i/T610/ T630/W310i/W510i/W700i/W800i/W810i	
	from £99.48



Mobile phone cradle from: £99.48

Interior

	Total (inc.VAT)
Privacy shades – rear doors (pair)	
– Agila	£61.56
– Corsa	£61.95
Privacy shades – tailgate	
– Agila	£68.61
– Corsa	£61.95
Privacy shades – tailgate and side glass set	
– Antara	£74.87

Essential accessory packs

	Total (inc.VAT and fitting*)
Safety Pack – First aid kit/Warning triangle/ Hi-visibility vest	
– all models	£24.47
Protection Pack – Velour mats (four)/ Mudflaps (four)/Cargo liner	
– all models except Agila/Tigra/Astra TwinTop/ Insignia/VXR8	£155.62
– Agila	£141.91
Protection Pack – Velour mats/Windbreak	
– Tigra	£194.77
Protection Pack – Deluxe velour mats/Windbreak	
– Astra TwinTop	£243.70

Towing

	Total (inc.VAT)
Corsa	
Detachable tow bar (fitted*)	
– 12N electrics	£450.21

	Total (inc.VAT)
Meriva	
Detachable tow bar (fitted*)	
– 12N electrics	£450.21
– 12N/12S electrics	£510.52
Towing mirrors (pair)	£129.78

	Total (inc.VAT)
Astra 11.18	
Fixed tow bar (fitted*)	
– 12N electrics	£235.46
– 12N/12S electrics	£315.41
– 13-pin electrics	£276.93

	Total (inc.VAT)
Detachable tow bar (Sport Hatch/hatch) (fitted*)	
– 12N electrics	£450.21
– 12N/12S electrics	£468.11
– 13-pin electrics	£429.61

	Total (inc.VAT)
Detachable tow bar (estate) (fitted*)	
– 12N electrics	£450.21
– 12N/12S electrics	£521.93
– 13-pin electrics	£483.44

	Total (inc.VAT)
Astra TwinTop	
Detachable tow bar (fitted*)	
– 12N electrics	£450.21
– 12N/12S electrics	£494.53
– 13-pin electrics	£456.04
Towing mirrors (pair)	£129.78



Towing mirrors from: £129.78 (pair)

Zafira 11

	Total (inc.VAT)
Fixed tow bar (fitted*)	
– 12N electrics	£325.49
– 12N/12S electrics	£405.47
– 13-pin electrics	£366.97
Detachable tow bar (fitted*)	
– 12N electrics	£450.21
– 12N/12S electrics	£527.81
– 13-pin electrics	£489.32

	Total (inc.VAT)
Vectra 11	
Fixed tow bar (hatch/saloon) (fitted*)	
– 12N electrics	£295.86
– 12N/12S electrics	£372.89
– 13-pin electrics	£342.51

	Total (inc.VAT)
Fixed tow bar (estate) (fitted*)	
– 12N electrics	£289.98
– 12N/12S electrics	£367.02
– 13-pin electrics	£336.63

	Total (inc.VAT)
Detachable tow bar (hatch/saloon) (fitted*)	
– 12N electrics	£450.21
– 12N/12S electrics	£502.09
– 13-pin electrics	£471.71

	Total (inc.VAT)
Detachable tow bar (estate) (fitted*)	
– 12N electrics	£450.21
– 12N/12S electrics	£546.13
– 13-pin electrics	£515.74
13-pin to 7-pin adaptor for 12N/12S electrics (estate) (for use with factory-fitted retractable tow bar)	£49.91
Towing mirrors (pair)	£129.78

	Total (inc.VAT)
Antara	
Detachable tow bar	
– 12N electrics (fitted)	£572.84
– 13-pin electrics	£600.68
Towing mirrors (pair)	£129.78

18 = Astra 1.4/1.6 models require additional components at extra cost. Please consult your retailer for further details and prices.

Our commitment to innovation, quality and reliability helps make every Vauxhall both enjoyable to drive and easy to live with. Invest in a new Vauxhall, however, and you'll get far more than a great drive. You also gain access to a range of customer-led products and services that set high standards for customer care and support.

Customer Care Commitment

For added peace of mind, Vauxhall has an innovative Customer Care Commitment* that offers the following:

- A one-year unlimited mileage manufacturer's warranty
- Second and third year no-fee customer option warranty up to 60,000 miles (100,000 miles Vivaro/Movano Combi models) from first registration
- Vauxhall Assistance for 12 months from first registration
- Six years body panel anti-perforation warranty

* *Warranty is only on vehicles sourced from General Motors UK Limited. Terms and conditions apply – please see your Vauxhall retailer for details.*

Protecting the environment

Vauxhall's commitment to the environment is demonstrated by our products' many environmental awards. Further details, including new initiatives such as our innovative Recycling Allowance programme, are available on page 3. For even more information on Vauxhall's efforts to achieve an environmentally sustainable future, see www.vauxhall.co.uk/recycling

Vauxhall Assistance**

Vauxhall Assistance is provided automatically with every new Vauxhall for 12 months from first registration and covers everything from accident assistance, roadside recovery and 'at home' service to flat tyres. With Vauxhall Assistance help is literally just a free† phone call away, 24 hours a day, 365 days a year!

** *Conditions may apply to Combi models.*

† *Mobile phone users will be charged at their standard tariff.*

In the event of an accident...

Vauxhall Accident Support helps keep you mobile following an accident. Benefits include scene-of-accident advice, message service, assistance with claims and vehicle recovery. For further details call **0800 010 304**.

Alternatively, details can be found on our website at www.vauxhall.co.uk

MasterFit

Vauxhall's MasterFit retailers offer a great service for owners of all Vauxhall cars. Value for money, regular offers and free check-ups, combined with the peace of mind that comes from using trained technicians and genuine parts, help keep your car in peak condition at all times. Every MasterFit retailer supports our customer promise:

- **Convenience** for our customers in every aspect of the MasterFit experience
- **Professional** advice on what work is essential and what is desirable
- **Value** assured by our monthly local price check
- **Transparent** pricing and invoicing. Any amendments or variations to work will be agreed with the customer before it is started
- **Latest diagnostic equipment** used on your Vauxhall to maintain its safety, reliability, emissions and performance
- **Vehicle and software enhancements** advised on Vauxhall's database will be carried out free-of-charge www.vauxhall.co.uk/masterfit

For more product information

For a brochure on any Vauxhall model (up to a maximum of three per caller) or location of your nearest Vauxhall retailer please Lo-call **0845 600 1500**. Alternatively, details can be found on our website at www.vauxhall.co.uk



MasterFit Service Plan



- Fixed monthly payments for the plan duration
- Easy to budget and interest-free
- Genuine parts fitted by trained technicians

Plus on Gold plans:

- Valet and courtesy car
- Full AA cover
- Engine flush and fuel treatments
- Litre of oil for top ups between services

Full details can be obtained from your local participating Vauxhall retailer.

Vauxhall Insurance with added reassurance

Comprehensive cover – Summary of benefits*

- Competitive premiums
- Repairs by a Vauxhall technician
- Genuine Vauxhall parts, guaranteed for three years when we repair your vehicle within our Approved Repairer Network
- Free courtesy car as standard when using an Approved Repairer**
- 24 hour claims helpline
- Personal accident benefit
- Cover for audio equipment
- Windscreen cover

Call for a quote on 0844 84 85 840 (Great Britain) or 0845 351 3410 (Northern Ireland)†

*The benefits listed above are for comprehensive cover only. For details of third party, fire and theft cover, please call our sales team. ** Should your car need repairing following an accident, we provide a courtesy car (subject to availability) for the duration of the repair. Only genuine Vauxhall parts are used. Terms and conditions apply. † Calls may be recorded. Vauxhall Motor Insurance is underwritten and administered by Provident Insurance plc (Great Britain) and AXA Insurance Limited (Northern Ireland).

Sureguard protection

Should you wish to enjoy Vauxhall Assistance for a full three years from first registration, then new Sureguard Assistance is for you. Both Warranty and Assistance products now come with the added peace of mind of Sureguard MOT Warranty. For details contact your Vauxhall retailer or call **0870 752 7020**.

	Sureguard Assistance (inc. MOT Warranty) 36 months††	Sureguard Warranty (includes Assistance and MOT Warranty)‡
		48 months††/ 60,000 miles††
Agila / Corsa / Meriva	£139.00	£325.00
Astra / TwinTop / Zafira / Tigra	£139.00	£375.00
Insignia / Vectra / Signum	£139.00	£425.00
Antara	£139.00	£599.00
Vivaro / Movano	£225.00	£635.00

Prices quoted include VAT or IPT (Sureguard Assistance only) and were correct at time of going to press but are subject to change without prior notice. †† From date of vehicle's first registration. Cover will expire at the end of the cover period/mileage limit whichever is the sooner. ‡ Assistance cover year 4 only.

Trust Vauxhall

Fleet Customer Services

Our dedicated support services for fleet managers includes factory demonstrators, a three-day test drive programme and information on whole life costs, company car taxation and finance. For further information please call **0870 010 0651**.

Vauxhall Rental

A nationwide network guarantees well prepared and maintained Vauxhalls for rental at competitive rates which include insurance and Vauxhall Assistance. For further information please call **0870 442 1567**.

Specialist Mobility advice

Motability accredited Vauxhall retailers can provide special mobility help and advice. Blue badge holders are entitled to very favourable discounts on new vehicles. Contact your local Motability accredited Vauxhall retailer or Freefone **0800 731 5267**.

Buying your car

GMAC offers one of the most comprehensive and competitive ranges of financing plans in the UK. Contact your local Vauxhall retailer for details or call the GMAC customer service centre on **0845 712 3444**.

Vauxhall Leasing

As Vauxhall's own contract hire and fleet management operation, Vauxhall Leasing provides a one-stop-shop for competitive car and van leasing solutions – for business users and private individuals. Working with the Vauxhall retailer network, we combine the support of a national contract with the convenience of a local contact. For further information, please see your local Vauxhall retailer or call us on **0870 737 2557**. Alternatively, you can visit our website at www.vauxhall-leasing.co.uk



- Save up to £1500* on a new Vauxhall with The GM Card
- 100 Rebate Points worth £100 when you use The GM Card for the first time
- Rebate Point saving is on top of any discount or offer negotiated with the Retailer
- Earn 3 Rebate Points (£3) for every £100 you spend

Typical 14.9% APR variable

To apply call **0845 746 2777** or visit www.gmcard.co.uk



When you have finished with this brochure please recycle it

The GM Card is issued by HFC Bank Limited and is available to persons aged 18 years or over and resident in the UK (or 21 and over in the Channel Islands) and is subject to status and conditions. Written quotations are available upon request from The GM Card, PO Box 3615, Birmingham B3 2RJ. The typical APR quoted is the rate for new customers. Rebate Points are earned on purchases using The GM Card. Rebate Points are not earned on Balance Transfers or Cash Advances. You earn money off a new Vauxhall/Saab by accumulating Rebate Points under the Rebate Points Programme. General Motors UK Limited is solely responsible for the operation of the Rebate Points Programme, which is subject to the Rebate Points Programme Rules. *You can redeem up to 2500 Rebate Points subject to the Model Line Maximum which will vary in amount in relation to different Vauxhall/Saab vehicle model lines and unlimited Partner Points. Rebate Points and unlimited Partner Points are redeemable as discounts on a new Vauxhall/Saab vehicle and must be redeemed four years from the issue date. Rebate Points may not be redeemed by Motability Contract Hire customers. The GM Card is a trading name and style of both HFC Bank Limited and General Motors UK Limited. HFC Bank registered in England No. 11117305. Registered Office: North Street, Winkfield, Windsor, Berkshire SL4 4TD is authorised and regulated by the Financial Services Authority **Member HSBC Group**. HFC Bank Limited is not a member of the same group of companies as General Motors UK Limited, Saab GB Limited or GMAC UK plc. General Motors UK Limited, Registered Office: Griffin House, Osborne Road, Luton, Bedfordshire LU1 3YT. Registered in England number 135767. – CN6/0987.

Every effort has been made to ensure that the contents of this publication were accurate and up-to-date at the time of going to press (January 2009). The invoice price, including delivery to retailer, factory-fitted options, accessories fitted by the retailer and number plates, is subject to VAT. The right is reserved to alter specifications and prices, and withdraw products from sale, without notice. Please note that Vauxhall retailers are not the agents of General Motors UK Limited and are not authorised to bind the Company by any specific or implied undertaking or representation. It is advisable to ensure that your motor insurance policy provides adequate cover for additional fitted options and accessories. Please note accessories shown are for illustrative purposes only. As part of Vauxhall's policy of environmental care, this brochure is printed on paper manufactured using Elemental Chlorine Free pulps from specially farmed, sustainable timber resources. All rights reserved. No part of this publication may be reproduced in any form or by any means, without the prior written permission of General Motors UK Limited.

VM0908323

Published January 2009 (Graymatter)

General Motors UK Limited, Luton LU1 3YT

www.vauxhall.co.uk

© General Motors UK Limited 2009



VAUXHALL